



USER MANUAL

26732-01A

STANDARD 48 MONTH WARRANTY

Your ETS Distributor (including ETS, Inc. if purchased directly), through a manufacturer's warranty, warrants your tanning unit to be free of structural defects in material and workmanship, under normal use, for its lifetime. Your ETS Distributor will, at its discretion, repair any structural defect which materially affects the performance of the tanning unit, or replace the tanning unit.

For forty-eight (48) months following the shipping date of your tanning unit, your ETS Distributor will provide replacements for parts that prove to be defective in material or workmanship. Fluorescent lamps, and lamp starters are warranted against manufacturer's defects for a period of ninety (90) days following the shipping date of your tanning unit. Acrylics will be warranted against manufacturer's defects for a period of 2 years (prorated).

Labor costs associated with repair or replacement work covered by this warranty will be reimbursed for repair or replacement work required to be performed for a period of one (1) year following the shipping date of your tanning unit. Normal wear and tear, damage from misuse or abuse, damage incurred in transit or damages resulting from unauthorized repairs or modifications are not covered by this warranty. Warranty coverage does not include cosmetic abnormalities such as scratches, nicks, dents, or other cosmetic changes that do not materially interfere with the function of the tanning unit.

THIS STANDARD 48 MONTH WARRANTY IS EXPRESSLY MADE IN LIEU OF ANY OTHER WARRANTIES, EXPRESS OR IMPLIED, INCLUDING ANY IMPLIED WARRANTIES OF MERCHANTABILITY AND FITNESS FOR A PARTICULAR PURPOSE, WHICH ARE HEREBY DISCLAIMED. No one has the authority to change or modify this Standard 48 Month Warranty in any respect. To obtain service under this Standard 48 Month Warranty, contact your authorized ETS Distributor (or ETS, Inc. if purchased directly). Proof of purchase, including serial number, is required.

IN NO EVENT SHALL YOUR DISTRIBUTOR OR THE MANUFACTURER BE LIABLE AT LAW OR IN EQUITY FOR ANY LOSS, LIABILITY, DAMAGE OR EXPENSE IN AN AMOUNT IN EXCESS OF THE PURCHASE PRICE RECEIVED, OR FOR LOSS OF USE OR PROFITS, LOSS OF TIME, INCONVENIENCE, RENTAL OR SUBSTITUTE PRODUCTS, LOSS OF BUSINESS, LOSS OF INCOME, OR ANY OTHER INCIDENTAL, INDIRECT, SPECIAL OR CONSEQUENTIAL DAMAGES. Some states do not allow the exclusion or limitation of incidental or consequential damages, and the above limitation or exclusion will not apply to residents of some states. This Standard 48 Month Warranty gives you specific, legal rights and you may have other rights which may vary from state to state.

All warranty service must be performed by an authorized service person. All labor charges must be authorized by your ETS Distributor prior to the start of repairs and must not exceed the established rates and time allotment policies established by your ETS Distributor. If your tanning unit must be returned for service, all freight charges shall be at your expense. Contact your ETS Distributor for the authorized Service Center nearest you. This warranty is serial number specific and only applies to tanning units purchased through an authorized ETS Distributor. This warranty is extended to the individual or legal entity whose name appears on the original sales document and may not be transferred to any other individual or legal entity. This warranty is void if the tanning unit is modified in any manner from its original design.

To obtain warranty service, contact your place of purchase. Proof of purchase, including serial number, is required for verification. Contact ETS, Inc. only if you purchased your equipment directly.

**ETS, Inc. 7445 Company Drive, Indianapolis, IN 46237-9296
1-800-449-3605 In Canada call 1-800-661-6292 or 519-421-1212**



Welcome

Congratulations on your purchase of this technologically advanced sun tanning unit. It has been designed to provide years of dependable service for you.

Please read all the instructions in this booklet before using the unit. Always be sure to observe all safety precautions.



Contents

Safety Informationiii
Installation1
Pre-Installation Planning1
Unpacking and Inspection2
Package Contents2
Operation3
Before You Tan3
Exposure Times3
Using Your Sunbed4
Setup6
Stereo Installation6
Remote Connections7
Care and Maintenance11
Cleaning After Use11
Thorough Periodic Cleaning11
Mechanical Inspection11
Lamp and Acrylic Replacement12
Inside the Bench18
Technical Information19
Setting Operating Parameters19
Troubleshooting22
Power Hookup25



Safety Information



LABELING NOTICE: Labels are affixed on all systems to inform the user of possible dangers. Regulations are stated in 21 CFR, Section 1040.20, and require that all products manufactured after September 8, 1986 which use sunlamps must display the following:

DANGER Ultraviolet radiation. Follow instructions. Avoid overexposure. As with natural sunlight, overexposure can cause eye and skin injury and allergic reactions. Repeated exposure may cause premature aging of the skin and skin cancer. **WEAR PROTECTIVE EYEWEAR; FAILURE TO DO SO MAY RESULT IN SEVERE BURNS OR LONGTERM INJURY TO THE EYES.** Medications or cosmetics may increase your sensitivity to the ultraviolet radiation. Consult physician before using sunlamp if you are using medications or have a history of skin problems or believe yourself especially sensitive to sunlight. If you do not tan in the sun, you are unlikely to tan from the use of this product. Children, the elderly, or fair skinned people who always burn easily and either never tan or tan minimally should not use this equipment.

To use, lie down under canopy and pull down as far as adjustment will allow maintaining at least 6.5 inches (16.5 centimeters) between your body and canopy clear plastic panel and side tanner clear plastic panel, otherwise overexposure may occur. Minimum use distance elsewhere is touching the clear plastic panels. Do not use without clear plastic panels in place. Untanned persons should not tan on consecutive days during their first week of tanning. Never tan more than once a day. Tanning normally appears after the first few sessions and maximizes after approximately four weeks. Tan once or twice per week thereafter to maintain appearance. Persons already having a base tan may begin at advanced levels corresponding to the extent of their base tan.

RECOMMENDED EXPOSURE TIMES IN MINUTES		MAXIMUM EXPOSURE TIME IS 10 MINUTES				
Skin Type:		Level 1/Week 1 1st-3rd Sessions	Level 2	Level 3	Level 4	Subsequent Maximum
I Sensitive Skin	(Burns easily and severely and does not tan.)	NOT RECOMMENDED FOR TANNING				
II Light	(Burns easily and severely and tans minimally.)	2	4	6	8	10
III Normal	(Burns moderately and tans average.)	3	5	7	10	10
IV Dark	(Burns minimally, tans easily and above average.)	4	6	8	10	10

WARNING: • Read the instructions booklet before using this sunlamp product. • All persons in the room should wear protective eyewear when lamps are on. Recommended eyewear: provided eyeshields or equivalent eyewear as defined under 21 CFR 1040.20. Other types of eyewear may not provide adequate protection. Failure to use protective eyewear may result in severe burns or other eye injury. If discomfort develops, discontinue use and consult a physician.

ONLY THE FOLLOWING LAMPS HAVE BEEN CERTIFIED FOR USE IN THIS EQUIPMENT:

- BRONZING SUN™ GOLD Wolff® Model BSG 71-T12-200W VS-R BI-PIN
- SPEED® 525VS-R Wolff® Model SPD71-T12-525VS-R 200W Bi-Pin
- Heraeus OH 30/50 or Heraeus OH 24/50 (facial unit)
- MARQUIS, Wolff System® Model CF26W (shoulder unit)

DISCONNECT POWER BEFORE ATTEMPTING TO CLEAN, RELAMP, OR ENGAGE IN THE MAINTENANCE OF THIS PRODUCT.

THIS EQUIPMENT MUST BE EARTH GROUNDED.

This product is in conformity with performance standards for sun lamp products under 21 CFR PART 1040.20 and ANSI/UL Standard 482. Certified to CAN/CSA Standard C22.2 NO. 224.





DANGER Rayonnement ultraviolet. Veuillez suivre les instructions. Évitez une exposition excessive. Tout comme pour les rayons du soleil, une exposition excessive peut causer des blessures aux yeux et à la peau et provoquer des réactions allergiques. Une exposition répétée peut causer le vieillissement prématuré de la peau et provoquer le cancer de la peau. **PORTEZ DES LUNETTES PROTECTRICES: LE NON-RESPECT DE CETTE CONSIGNE DE SÉCURITÉ PEUT ENTRAÎNER DE GRAVES BRÛLURES OU DES LÉSIONS OCULAIRES À LONG TERME.** Les médicaments ou les produits cosmétiques peuvent augmenter votre sensibilité au rayonnement ultraviolet. Consultez un médecin avant d'utiliser la lampe solaire si vous prenez des médicaments, si vous souffrez d'une maladie cutanée ou si vous croyez être particulièrement sensible aux rayons du soleil. Si vous ne bronzez pas au soleil, il est peu probable que vous bronzez sous une lampe solaire. Les enfants, les personnes âgées et les personnes qui ont une peau claire qui brûle facilement, ne bronze jamais ou alors très peu, ne devraient pas utiliser cette lampe.

Étendez-vous sous la partie supérieure, puis abaissez celle-ci aussi bas que possible, en veillant cependant à conserver un espace d'au moins 6,5 pouces (16,5 centimètres) entre le corps et le panneau de plastique transparent de la partie supérieure et le panneau de plastique transparent de l'appareil de bronzage latérales, afin d'éviter une exposition excessive. Les autres parties du corps peuvent toucher les panneaux de plastique transparents. N'utilisez pas la lampe sans les panneaux de plastique transparents. La première semaine de bronzage, les personnes qui n'ont pas un hâle initial ne doivent pas se faire bronzer tous les jours. Ne vous faites jamais bronzer plus d'une fois par jour. Le bronzage commence normalement à apparaître après les premières séances : il atteint son apogée au bout d'environ quatre semaines. Les personnes qui ont déjà un teint hâlé peuvent commencer à des niveaux plus élevés, selon l'importance de leur hâle initial.

TEMPS D'EXPOSITION RECOMMANDÉ EN MINUTES LE TEMPS D'EXPOSITION MAXIMAL EST DE 10 MINUTES					
Type de peau:	Élevé 1/Semaine 1 1 ^{ère} -3 ^e	Élevé 2	Élevé 3	Élevé 4	Sem. suivantes Temps maximal
I Peau sensible (brûle facilement et ne bronze pas)	NON RECOMMANDÉ				
II Peau claire (brûle facilement et bronze très peu)	2	4	6	8	10
III Peau normale (brûle et bronze de façon modérée)	3	5	7	10	10
IV Peau foncée (brûle très peu, bronze plus facilement que la moyenne)	4	6	8	10	10

AVERTISSEMENT : • Lisez le livret d'instructions avant d'utiliser cette lampe solaire. • Les autres personnes présentes dans la pièce doivent aussi porter des lunettes protectrices lorsque les lampes sont allumées. Coquilles de protection pour les yeux recommandées: Les coquilles de protection fournies ou l'équivalent, tel que le stipule le document 21 CFR 1040.20. Les autres types de lunettes protectrices peuvent ne pas assurer une protection adéquate. Utilisé sans lunettes protectrices, ce produit peut causer des brûlures ou lésions oculaires graves. Si vous souffrez d'un malaise, arrêtez l'utilisation et consultez un médecin.

SEULES LES LAMPES SUIVANTES ONT ÉTÉ HOMOLOGUÉES POUR CET ÉQUIPEMENT :

BRONZING SUN™ GOLD Wolff® Modèle BSG 71-T12-200W VS-R BI-PIN

SPEED® 525VS-R Wolff® Modèle SPD71-T12-525VS-R 200W Bi-Pin

Heraeus OH 30/50 ou Heraeus OH 24/50 (unité faciale)

MARQUIS, Wolff System® Modèle CF26W (unité en bandoulière)

Débrancher l'alimentation électrique avant de nettoyer l'appareil, d'en faire l'entretien ou de changer les lampes.



CET ÉQUIPEMENT DOIT ÊTRE MIS À LA TERRE.

Ce produit est conforme aux normes de rendement pour les lampes solaires dans les documents 21 CFR, partie 1040.20, ANSI/UL 482, CAN/CSA C22.2 N° 224.



Installation

Pre-Installation Planning

Before your sunbed is installed, you should observe the following considerations.

	⚠ DANGER
	Shock hazard. Disconnect power before servicing.

⚠ WARNING
Always wear protective eyewear when unit is on. Failure to may result in severe burns or longterm injury to the eyes.

- The **SS755** requires a dedicated circuit capable of providing either **49 Amp, 3-phase** service (3 wire plus ground) or **85A, 1-phase** service (2 wire plus ground) at **220VAC**. This unit must be hardwired directly to a junction box on a dedicated circuit. We recommend connection by a professional electrician. Consult local and/or national codes for proper circuit breaker and wire gauge.
- The subwoofer in the bench requires a standard 110VAC outlet near the back of the unit.
- **IMPORTANT!** Operating voltage must be below 230V AC or may require a Buck Booster.

⚠ CAUTION
Use of a voltage source above 230V AC (with unit running) may prevent proper operation of the sunbed and could cause damage and void the warranty.

⚠ CAUTION
Air from the room is used to cool the sunbed. Maximum ambient room temperature should be 80°F. Place your sunbed no closer than 6" from side walls. May be positioned against back wall. Make sure nothing obstructs the airflow into or out of the fan openings. A poorly ventilated room may cause the unit to become hot and cause discomfort to the user.

Unpacking and Inspection

Your sunbed arrives fully assembled. Some disassembly may be necessary to transport the unit into your salon. Due to the size and weight of the unit we recommend installation by professional technicians.

After unpacking, inspect the unit to make sure it is free from any visible damage. Report the extent of any damage to the transportation company.

Record the serial number, located on the rear of the unit, in the area provided below. This information will be required whenever you call Customer Service.

Record this information for ease of service:

Date of purchase: _____

Serial number: _____

Package Contents

In addition to a pillow and a few items left over from the assembly, the following items are provided for use and maintenance.

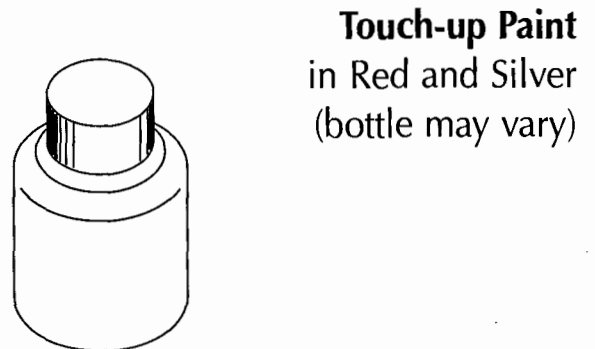
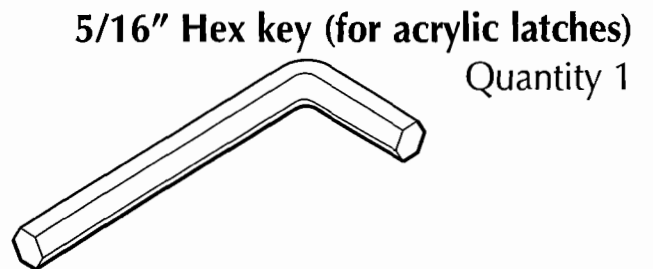
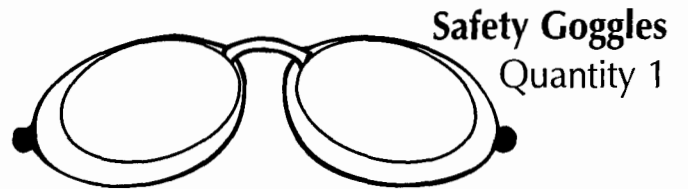



Operation

Before You Tan

Before using your sunbed, please note the following important precautions.

- Your skin should be free of cosmetics, oils, or other body lotions prior to tanning except for those specifically made for use with tanning devices. However, do not remove natural body oils by bathing or showering immediately before tanning.
- Your hair should be free of gels, mousses, sprays, or other hair products prior to tanning. These products can cause damage to the sunbed acrylic. As an alternative, a shower cap or towel can be worn to keep treated hair away from the sunbed surfaces.
- This unit intended for individual use. Only one pair of eyewear is included.

⚠ DANGER

Some medication may increase your sensitivity to ultraviolet light. It is recommended that you consult a physician before using this sunbed if taking any medication or if you suspect that your skin might be especially sensitive to sunlight.

⚡ DANGER

Shock hazard.
Do not operate this device near water or while you are wet.

Exposure Times

Follow the guidelines for skin type and exposure times as shown in the table below. Untanned persons should not tan on consecutive days during their first week of tanning. Never tan more than once a day. Tanning normally appears after the first few sessions and maximizes after approximately four weeks. Tan once or twice per week thereafter to maintain appearance. Persons already having a base tan may begin at advanced levels corresponding to the extent of their base tan.

RECOMMENDED EXPOSURE TIMES IN MINUTES		MAXIMUM EXPOSURE TIME IS 10 MINUTES				
Skin Type:		Level 1/Week 1 1st-3rd Sessions	Level 2	Level 3	Level 4	Subsequent Maximum
I Sensitive Skin	(Burns easily and severely and does not tan.)	NOT RECOMMENDED FOR TANNING				
II Light	(Burns easily and severely and tans minimally.)	2	4	6	8	10
III Normal	(Burns moderately and tans average.)	3	5	7	10	10
IV Dark	(Burns minimally, tans easily and above average.)	4	6	8	10	10

Using Your Sunbed

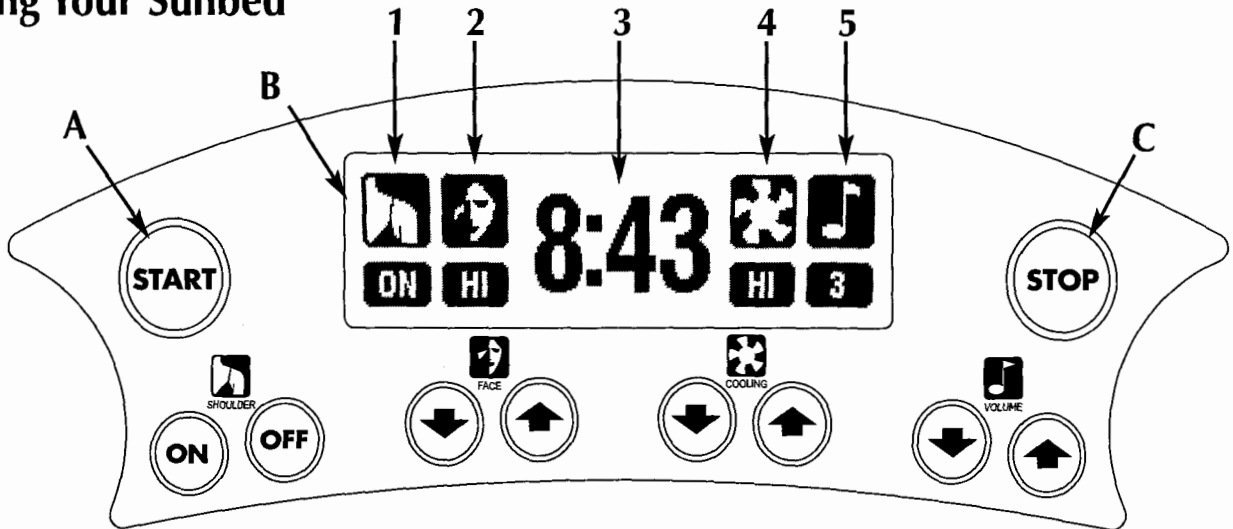

A Timer button - Turns bed on. Timer display shows remaining time. If a lesser time is desired, press timer button until desired time is displayed.

B Timer display - Displays session status. (See right)

C Stop button - Interrupts tanning session.

1 Shoulder Tanner Status - ON or OFF.

2 Face tanner status - OFF - LOW - HI

3 Remaining time

4 Body fan status - LOW - MED - HI

5 Volume status - OFF, 1-10

 **Shoulder tanner control** - Turns Shoulder Tanner on and off.

 **Face tanner control** - Adjusts intensity of Face Tanner.

 **Body fan control** - Controls the speed of the body fan during use.

 **Volume control** - Adjusts music level.

See next page for operating instructions. The timer is programmed at the factory with start-up defaults. To modify these, see *Setting Operating Parameters*.

! WARNING
Wear protective eyewear.
Failure to may result in severe burns or longterm injury to the eyes.

Operation - Using Your Sunbed

(Operation as a stand-alone unit or connected to a remote system using a control relay. If using T-Max® see right.)

1. Lift the canopy, lie down on the bench (face up), lower the canopy toward your body using the canopy handle. Maintain at least 6.5" (16.5 centimeters) between the canopy and your body.
2. Put on your safety goggles.
3. Press the START button (see *previous page*) to begin the tanning session. The unit will turn on and the timer will begin to count down. If a lesser time is desired, press the START button until the desired time is displayed.
4. When the timer reaches "0:00" the lamps turn off. If you want to stop your session before time expires, press the STOP button. You will have ten seconds to restart with the remaining time, otherwise the session will end.
5. Raise the canopy by pushing up on the outer edge of the canopy. Do not push up on the acrylic shield. The cooling fans run for 10 minutes after the lamps shut off to aid in cooling the sunbed.

(Operation while connected to a T-Max® remote system. If using other remotes or no remote system, see left.)

1. Lift the canopy, lie down on the bench (face up) and lower the canopy toward your body using the canopy handle. Maintain at least 6.5" (16.5 centimeters) between the canopy and your body.
2. Put on your safety goggles.
3. Assuming the remote system has been set to allow a pre-tanning delay time, the timer display will read "Press start when ready:" and the remaining delay time. Press the START button (see *previous page*) or wait until the delay time has expired to begin the tanning session. The unit will turn on and the timer will begin to count down.
4. When the timer reaches "0:00" the lamps turn off. If you want to stop your session before time expires, press the STOP button.
5. Raise the canopy by pushing up on the outer edge of the canopy. Do not push up on the acrylic shield. The cooling fans run for 10 minutes after the lamps shut off. The timer will indicate a reminder to clean the sunbed. After the sunbed is cleaned, press the START button and the display will return to the "welcome" screen.



Setup

Stereo Installation

The **SS755** accepts an input from a stereo source. The unit contains speakers inside the Shoulder Tanner, a subwoofer in the bench and an integrated amplifier in the bench ballast drawer. Volume control is conveniently located on the timer keypad (see *Using Your Sunbed*).

Locate the small, black box tethered to the back of the unit with cables (see right). There are three sets of inputs, RJ-22 remote ports (explained on the next page), speaker level input spring connectors and line level RCA input jacks. Connect the output from a stereo source (receiver, CD player, "boom-box", etc.) to either of the last two inputs. Whenever possible, use the RCA input jacks as this will eliminate problems with volume.

Once a source is connected, apply power to the sunbed (do not turn the sunbed on). If using the RCA jacks, setup is complete. If using the speaker terminals, adjust the volume on the source unit. Once a pleasant volume level is reached, use only the timer keypad to adjust it in the future. Two default volume levels, one lower level for when the unit is idle and a slightly higher level when the unit is turned on, keep the music audible yet not too loud for other tanners. See *Setting Operating Parameters* to change the

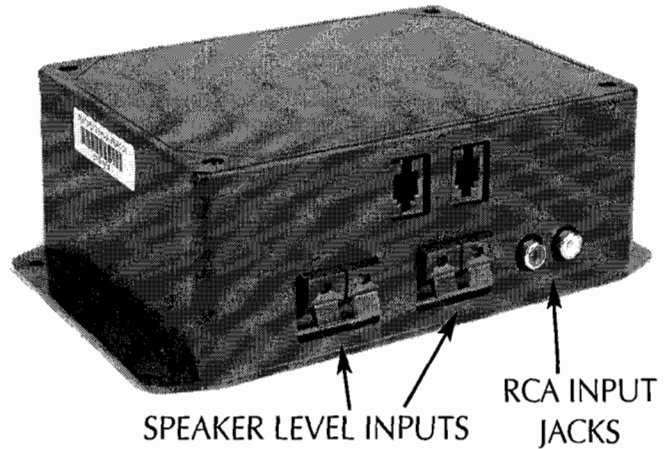

defaults. Music may play continuously through the sunbed during the day. The sunbed controls only the volume, so if the source is a CD player (or tape, etc.) you must control the music at the source unit.

To adjust the subwoofer output, remove the Front Access Panel (see *Inside the Bench*) and reach inside the hole on the left of the bench to access the subwoofer. There is a power button, phase button, cut-off control and level control (see below). Consult the subwoofer's user guide for more information. Adjust the level to achieve the bass response desired.

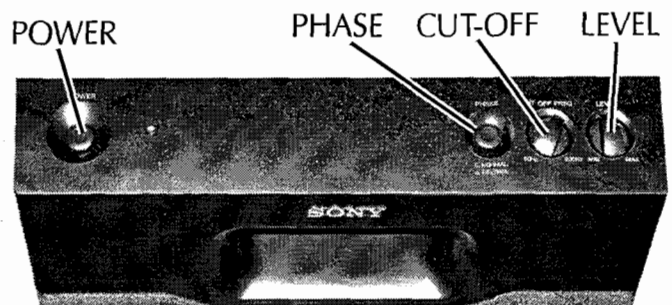

Remote Connections

Your sunbed incorporates advanced circuitry allowing it to connect and communicate with most remote control systems. If a remote system is to be used, first determine whether the remote system is a T-Max® System or a standard remote system operating with a control relay. Follow the appropriate instructions on the next few pages for your system type.

The RJ-22 Remote Ports on the tethered box (see right) allow connection to the remote system. Both remote ports are identical, allowing connection of multiple units in a "daisy chain" configuration. A Remote Control Bypass plug is already installed in one of the remote ports to bypass the remote functionality, otherwise known as "stand-alone" operation. Your sunbed will not operate without the Remote Control Bypass plug or a remote system connected.

RJ-22 REMOTE PORTS

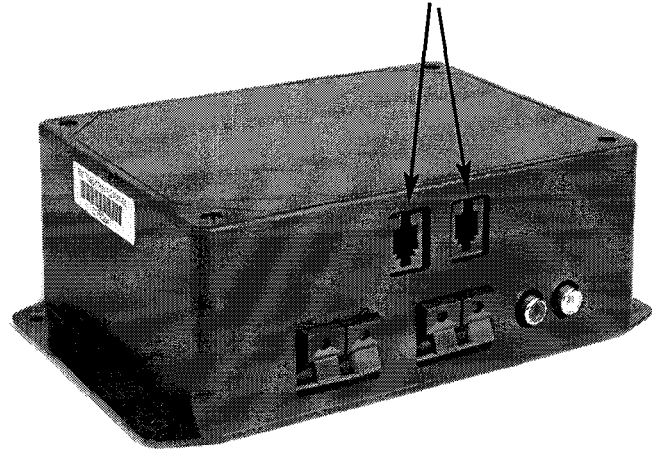

CAUTION

The remote connection is not designed to supply or accept high voltage, nor can it provide power to an external timer. The sunbed's remote interface circuitry operates on 5 volts, attempting to connect it to any higher voltages will damage the sunbed as well as void your warranty.

T-Max® Products

The T-Max® remote systems offer the ultimate in sunbed control, while allowing the tanner easy, straightforward operation. Your sunbed is configured to directly connect to this system. The circuitry inside your sunbed eliminates the need for the T-Max® 1A or 3A when connecting to the T-Max® Manager series. Your sunbed supports the auto addressing feature of the latest T-Max® Manager models and many parameters. See *Setting Operating Parameters* and your T-Max® manual for descriptions of these parameters and how they function.

Auto Addressing with T-Max®

Your T-Max® Manager manual will explain how to get into auto address mode. Once auto address has been activated, the bed display will show "Auto address active press start key to address." Wait 10 seconds for the system to communicate properly and press the START button. The display will indicate "waiting for address" and return to the welcome screen when it has accepted the address.

**Go straight to the source with all your T-Max® brand remote questions:
(417) 338-5101**

T-Max® Manager Remote System

This system is ideal for multiple sunbed installations. Simply connect the RJ-22 modular cable(s), described in the T-Max® Manager manual, into the remote port(s) located on the tethered input box and follow the instructions that came with your remote system, noting *figure 1*. If you have an older T-Max® Manager that does not support auto addressing, set the address of each sunbed manually as described on the next page. You can place your sunbed at any location in the series.

NOTE: A T-Max® 1A can be substituted for the 3A in *figure 1*.

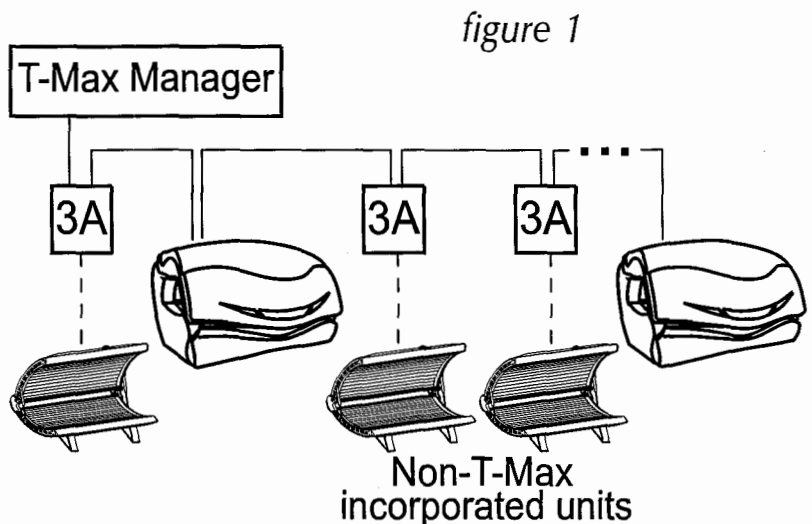

Setup - Remote Connections

T-Max® 1A and 3A Remote Systems

In single sunbed installations, the T-Max® 1A and 3A can offer the same control as the T-Max® Manager, eliminating the need for a Manager. If you're using a 1A in this manner, it must have a chip labelled "master" installed on its circuit board. The 3A may be used as a "master" with no modification.

After you have set the T-Max® 1A's, or 3A's, address to "0" (refer to your T-Max® user's guide) and the sunbed's address to "1" (see right), simply connect the RJ-22 modular cables, described in the T-Max® user's guide, directly into either port in the tethered box and either port on the back of the T-Max® 1A or 3A. See *figure 2*.

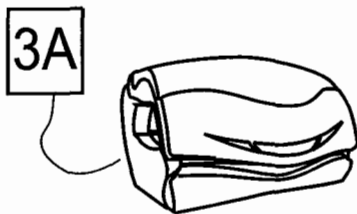

figure 2

NOTE: A T-Max® 1A with a "master" chip can be substituted for a 3A in *figure 2*.

Setting the address manually

Before connecting your sunbed to the T-Max® Manager or T-Max® 1A or 3A, the address of your sunbed must first be set. Set the "id" manually as described below.

Setting the address (parameter 1)

1. Press and hold the STOP button, located on the sunbed display, until the display enters the "settings" mode (approximately five seconds) and release. The screen will display #7 *TOTAL BED HOURS*. Press the Face Tanner down button until the screen displays #1 *BED ADDRESS*. The number to the right is the address, which may be anything from 1 to 128. Numbers 252 through 255 are reserved for other functions and should not be used as an address.
2. If you are using a T-Max® 1A or 3A as a "master" remote, the address of the sunbed must be set to "1". If you are using a T-Max® Manager each sunbed must be assigned a different address. Using the Body Fan Control up and down buttons, set the value to the appropriate address number.
3. Press the stop button to return to the normal display mode.

Remote systems using a Control Relay

Most non-T-Max® remote systems control the sunbed by the use of a relay. The relay operates the sunbed by connecting and disconnecting a pair of wires leading from the sunbed. Refer to the user's manual provided with your remote system to determine if it operates in this way. To connect your sunbed to this type of system a remote interface kit is required. Contact your place of purchase to obtain the kit. *Figure 3* details a typical connection. Follow the instructions provided with the kit and from the remote's manual to make the necessary connections.

CAUTION

The remote connection is not designed to supply or accept high voltage, nor can it provide power to an external timer. The sunbed's remote interface circuitry operates on 5 volts, attempting to connect it to any higher voltages will damage the sunbed as well as void your warranty.

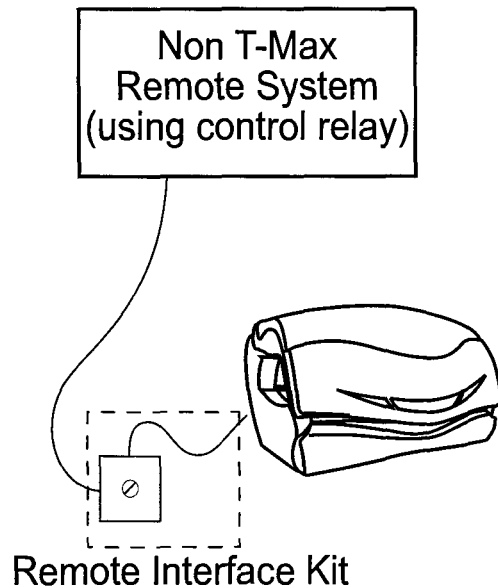

figure 3



Care and Maintenance

Cleaning After Use

Clean and disinfect your tanning bed's bench and canopy after each use. Use a non-abrasive disinfectant cleaner that **does not contain ammonia or ammonia derivatives**. Ammonia may damage the acrylic shield. Spray the acrylic lightly with disinfectant and wipe dry with a clean soft cloth. We recommend SunQuest® disinfectant and SunQuest® acrylic cleaner.

Thorough Periodic Cleaning

Introduction

The cooling fans draw air through the bed and over time will cause a dust buildup on the lamps and reflectors. This will reduce the tanning effectiveness of the bed. When a dust buildup is observed, it is necessary to thoroughly clean the inside of the bench and canopy.

	⚠ WARNING
	Shock hazard. Disconnect power before removing any protective covers.

- Open the acrylic shields and remove lamps as described in *Lamp and Acrylic Replacement*.
- With a soft cloth, wipe the entire length of each lamp to remove any film buildup.

- Clean both sides of the acrylic shields with a non-ammonia disinfectant cleaner.
- Wipe the reflectors with a clean damp cloth.
- Reinstall the lamps and acrylic shields.
- Replace air filters inside each bench end-cap. Replace with a 12" x 18" x 1" furnace filter.

Mechanical Inspection

Your tanning bed has been built for years of service. To ensure trouble-free operation throughout its life, inspect the unit's mechanical integrity every 400-500 hours of use.

- Inspect the unit's fasteners verifying that all are firmly in place.
- Inspect lift adjustment. Adjust for proper lift if needed. See *Inside the Bench*.
- Inspect all power cords and connections.
- Inspect the acrylics. Broken, cracked or badly scratched acrylics should be immediately replaced.
- Check damper operation. The damper limits the canopy's movement speed. Replace if canopy raises and lowers too quickly.

Lamp and Acrylic Replacement

Introduction

To be assured of maximum tanning effectiveness, change lamps after approximately 500-700 hours of use. Lamps used longer than that begin to lose their effectiveness even though they continue to light. To ensure trouble-free operation of your sunbed, replace the lamp starters whenever the lamps are replaced. See *Setting Operating Parameters* to find out how to monitor lamp hours.

	⚠ WARNING
	Shock hazard. Disconnect power before removing any protective covers.

⚠ CAUTION
Be careful. The edges of the acrylic shield may be sharp.

⚠ DANGER
Unfiltered light from face tanner can cause severe burns. Never turn sunbed on while face tanner is disassembled or when glass filters are removed. Immediately discontinue use of this equip- ment if face tanner glass is broken or any unfiltered light can be seen escaping the face tanner assembly.

Opening/Replacing Acrylic Shields

The acrylic shields are secured in place by turn latches. Use a 5/16" hex key (Allen wrench) to turn the latches a quarter turn to release the acrylic. The Rear Lamp Module acrylic sits in a channel along the bottom and simply lifts out. The Shoulder Tanner acrylic has three turn latches and lifts straight off. You may need to lift the Bench acrylic first.

Opening/Replacing Canopy Acrylic

Due to the size and weight of the Bench and Canopy acrylics, they are not easily removed. Instead, they employ a hinge across the back edge to allow cleaning and maintenance without removal. Using a 5/16" hex key (Allen wrench), turn the latches along the front edge of the Canopy acrylic one quarter turn and gently rest it on the Bench acrylic. Place a towel on the Bench acrylic to avoid scratches.

Screws secure the Canopy acrylic in the aluminum hinge channel at the rear. To remove, disconnect the timer display cable from the back of the timer display. Loosen the screws along the inside of the hinge channel. The acrylic will then slide out of the channel. Replace it by setting it in the hinge channel and tightening the screws. Connect the timer display cable.

Care and Maintenance - Lamp and Acrylic Replacement

Opening/Replacing Bench Acrylic

The Bench acrylic also does not need to be removed to perform normal maintenance, such as cleaning and replacing lamps. Turn the quarter-turn latches on either side of the acrylic and lift the front edge. Two gas springs hold it open.

A secondary acrylic rests below the main acrylic. Simply lift the secondary acrylic out to access the lamps.

To remove the Bench acrylic, lift the acrylic so the gas springs are fully extended. Each gas spring is held to the acrylic bracket with a locking pin. Unclip the pin and slide it out to disconnect the spring from the acrylic (see top right). Inside the Bench, at the back corners of the acrylic, are two keeper brackets (see bottom right). Swing the bracket up to free the Bench acrylic hinge. Raise the acrylic and lift it, along with the hinge channel, from the Bench. Replace the acrylic by setting the hinge channel in its slot at the rear of the Bench. Swing the keeper brackets down, and reconnect the gas springs.

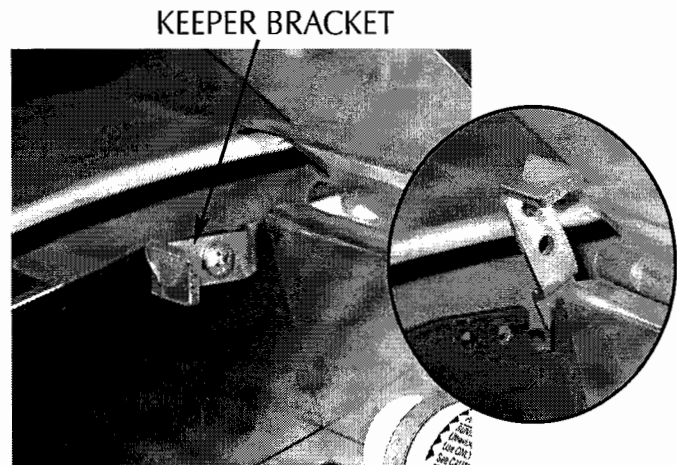
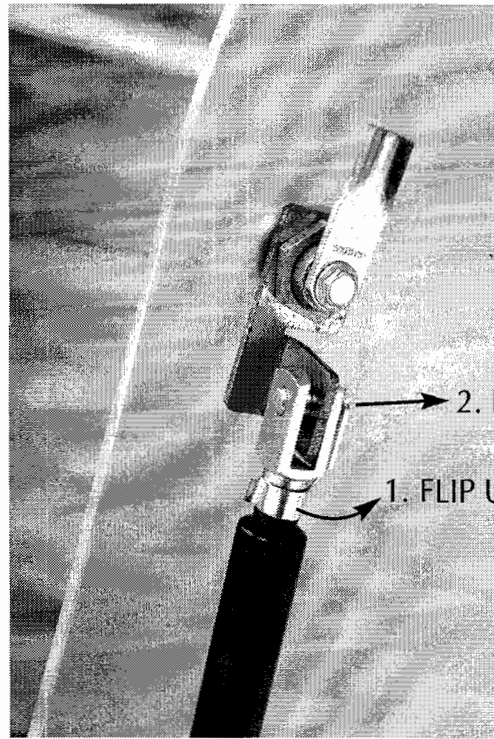

Removing/Replacing Face Tanner Lamps on the Canopy

After opening the Canopy acrylic shield, replace the face tanner lamps as follows:

The face tanner assemblies hinge open. With a flat-bladed screwdriver turn the latch (see top right) a quarter turn. The assembly will open, revealing the reflector and lamp holder.

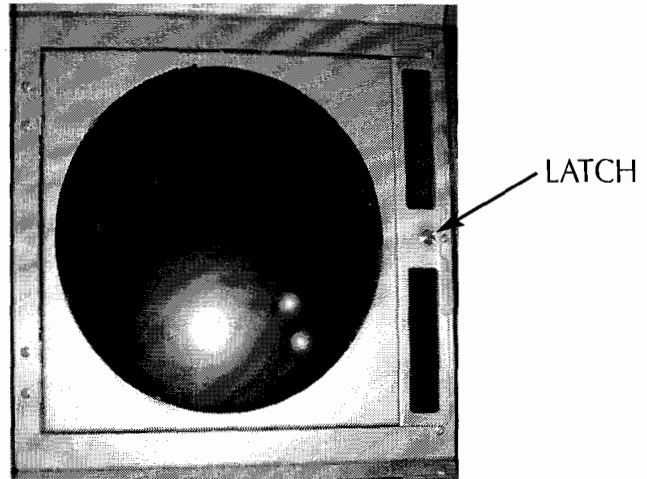

Remove the two screws (right) at the end of the face tanner assembly and carefully remove the end bracket and filter glass. The lamp can now be exchanged. Remove the old lamp by pulling it straight out, and discard. Install the new lamp, using a clean cloth or paper towel to avoid fingerprints on the lamp glass. Ensure that the lamp is firmly seated in the lamp holder.

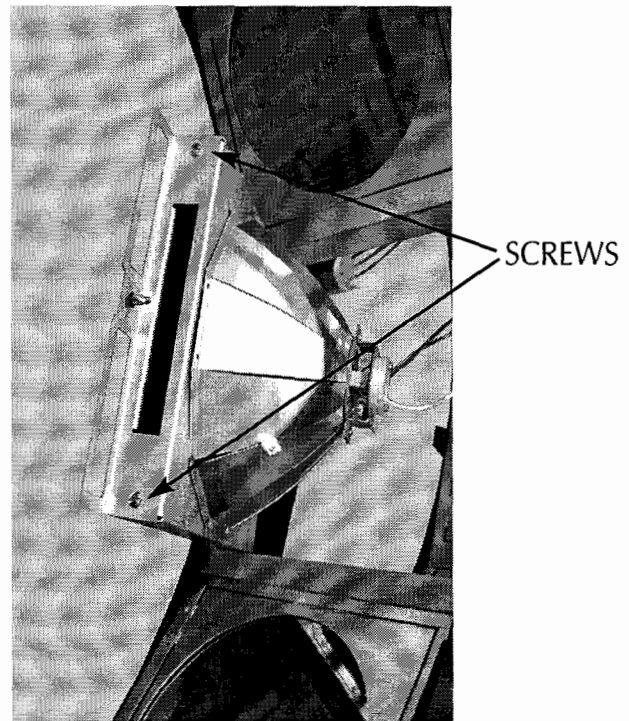

Note! Never take hold of the lamp such that your fingers are in contact with the lamp glass. Finger oils will greatly reduce the lamp's operational life.

Slide the filter glass back in. Fasten the end bracket to the assembly. Close the hinged assembly and simply press the latch until it clicks to secure.

Care and Maintenance - Lamp and Acrylic Replacement

Removing/Replacing Face Tanner Lamp in the Rear Lamp Module

The face tanner lamp is removed much the same way as in the Canopy. However, instead of hinging open, the face tanner assembly pulls completely out of the module. Carefully pull the right side toward you and slide the assembly to the right and out. Refer to the previous page for further instructions.

Removing/Replacing Main Lamps

After opening the acrylic, grasp a lamp at one end and at the middle and turn the lamp one quarter turn. Gently remove the lamp from its holders.

Reinstall the lamp by inserting the pins located on the ends of the lamp into the slots on top of the lamp holders and turn the lamp a quarter turn. It should click in place.

Recommended Replacement Lamps

We recommend using the lamps specified below. Use of uncertified lamps is a violation of Federal regulations and will void your warranty.

BRONZING SUN™ GOLD Wolff® Model BSG 71-T12-200W VS-R BI-PIN

SPEED® 525VS-R Wolff® Model SPD71-T12-525VS-R 200W Bi-Pin

Heraeus OH 30/50 or Heraeus OH 24/50 (facial unit)

MARQUIS, Wolff System® Model CF26W (shoulder unit)

Removing/Replacing Mood Lamp

Inside the front edge of the canopy is a lamp that remains on at all times. Remove and replace it exactly like one of the main fluorescent tube lamps. The red sleeve simply slides on and off. Replace with a Sylvania® **F72T12/D835/HO** lamp.

Removing/Replacing Shoulder Tanner Lamps

After removing the Shoulder Tanner acrylic, grasp a lamp by the white base (never by the lamp glass) and pull straight up. Replace the lamp by lining up the base pins with the socket and pressing firmly in place.

Recommended Replacement Acrylics

Acrylics vary greatly over time in their ability to effectively transmit UV light. Acrylics sold by ETS have been life tested to ensure proper transmission throughout their useful life.

Care and Maintenance - Lamp and Acrylic Replacement

Replacing Decorative Lamps

Inside the front of the canopy are three sets of fluorescent lamps (six lamps total) which illuminate the decorative windows. To access these lamps you must remove the front canopy cover. Follow these directions carefully.

Lift the canopy. Along the front edge of the canopy acrylic runs the handle channel. Remove the five screws in this channel and remove the entire channel piece (see above right). Pull the rear access panel back a few inches to expose the service lock holes (see right). Lower the canopy and insert two long, metal pins (such as screwdrivers) into the holes to keep the canopy down after the weight of the cover is removed.

The front half of the cover will now slide down (see below). -Continued on next page.-

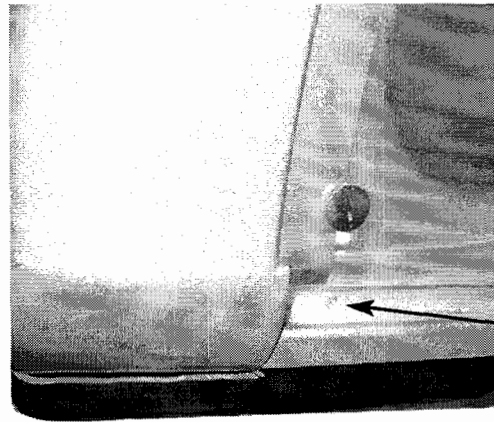

SCREW IN
HANDLE
CHANNEL

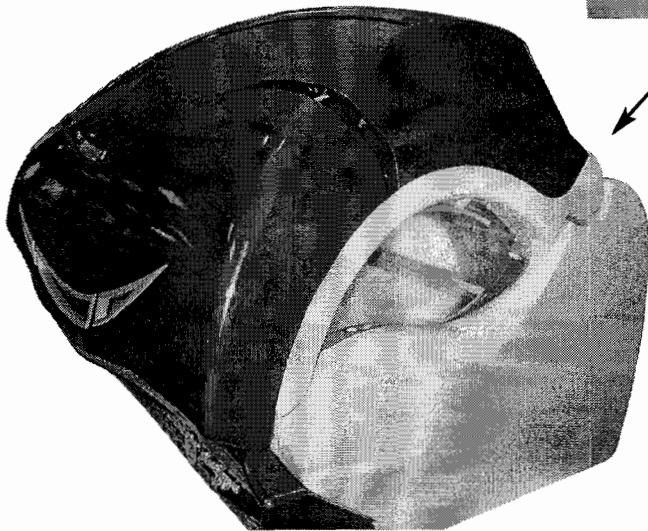
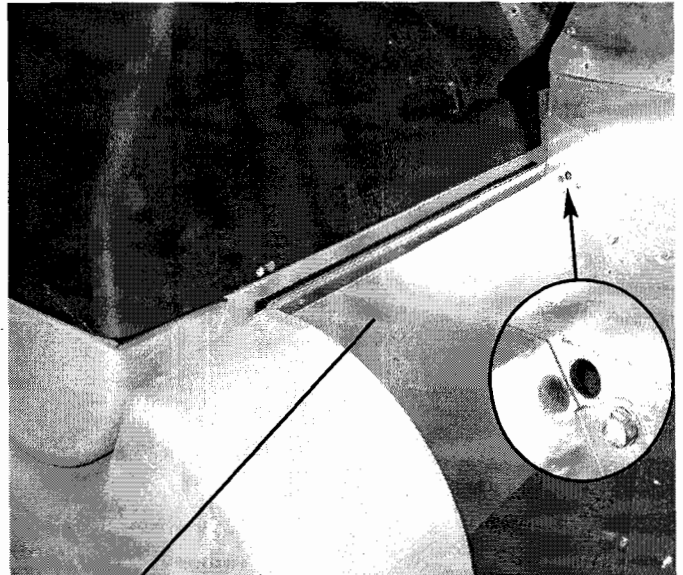

Care and Maintenance - Lamp and Acrylic Replacement

The front cover is secured by two springs. Unhook each spring and hook it to the hole in the upper cover to avoid losing the spring under the upper cover. If that happens, the upper cover simply lifts off after removing the five screws along its back edge.

Replace the lamps by twisting a quarter turn and pulling it gently from its lamp holders. It is recommended to replace all six lamps and their starters at the same time, even if only one is burned out, to avoid unnecessary handling of the canopy cover. Replace with standard 24" T8 17W lamps.

Reinstall the cover by reversing the previous directions.

	! WARNING
	Shock hazard. Disconnect power before removing any protective covers.

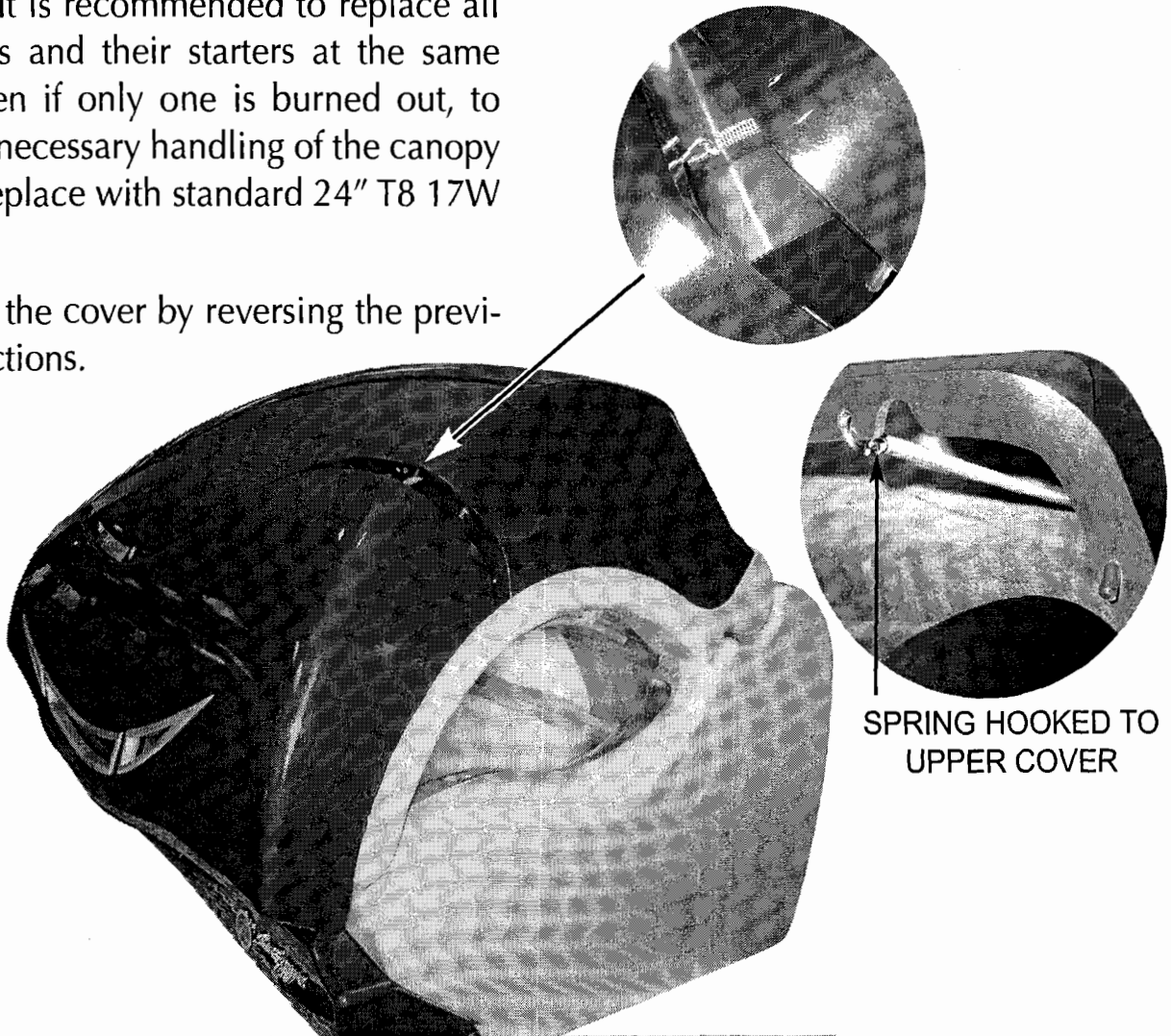

Inside the Bench

The contoured access panel on the front of the bench unlatches and pulls off to reveal four important components of the unit; the bench ballast drawer (with timer and amplifier components), the canopy ballast drawer, the lift adjustment mechanism and the air filters. The ballast drawers require no routine maintenance. Lift the bench acrylic and turn the latches along the top of the access panel to remove.

Lift Adjustment

Your sunbed uses a smooth gliding spring lift system to raise the canopy. Occasionally this lift system may need to be adjusted slightly. Use a wrench to turn the hex shaped Lift Adjustment lugs (shown below), clockwise for more lift and counterclockwise for less. When adjusted properly, the canopy should raise easily as well as rest fully closed. Always adjust both lugs equally.



Air Filters

On both sides of the bench are large blowers which provide the cooling air for the unit and the body cooling vents. Inside the bench endcaps are air filters to minimize the amount of dust entering the sunbed. Pull the small tab at the bottom of the filters to slide them out. Each side has two 12" x 18" x 1" furnace filters. The air-flow arrow on the edge of the filters must point toward the center of the unit when installed. Replace the filters whenever they appear dirty, or at least every 500 hours of use.

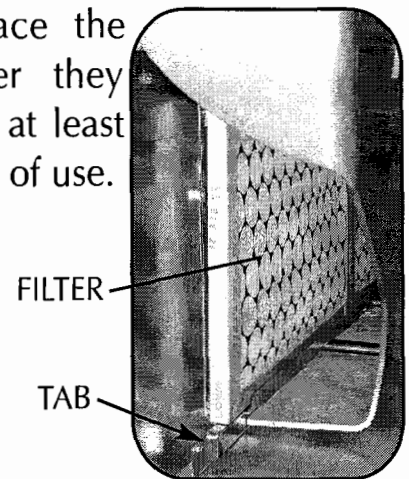

SUBWOOFER ACCESS

LIFT ADJUSTMENT LUGS

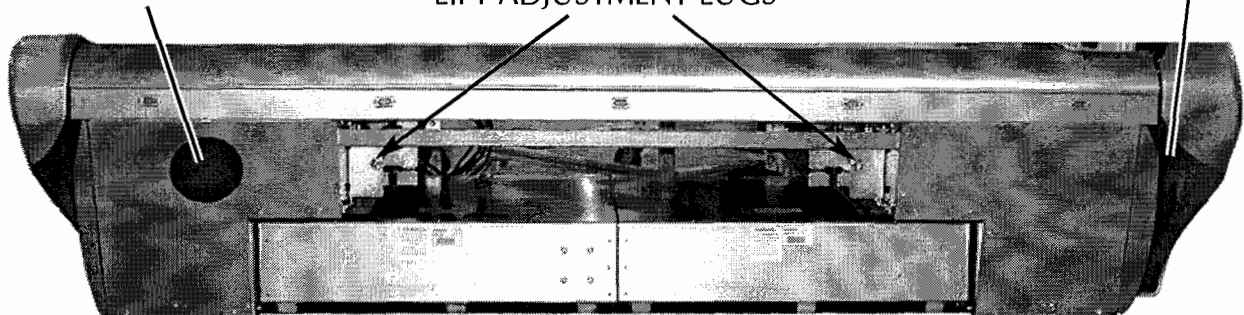



Technical Information

Setting Operating Parameters

The **SS755** allows some flexibility in how the unit operates. By entering a “settings” mode on the timer display you may view and/or adjust different operating parameters.

With the unit sitting idle, press and hold the Stop button (see page 4) for approximately 5 seconds. The following screen will appear:

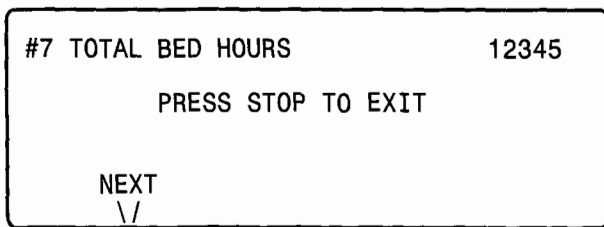

The first number corresponds to the parameter number, followed by the parameter name. The number at the right shows the value, in this case the total bed hours. Press **STOP** to exit the “settings” mode. Use the Face Tanner up and down buttons to scroll to the next screen.

The next page explains the five parameters which may be viewed and/or modified from the timer display. Following that is a list of the parameters recognized by the **SS755** timer attached to a T-Max® remote system.

Technical Information - Setting Operating Parameters

#7 TOTAL BED HOURS	12345
PRESS STOP TO EXIT	
NEXT	
∨∨	

#6 LAMP HOURS	12345
PRESS STOP TO EXIT PRESS START TO ZERO	
NEXT	CHG HRS
∨∨	∨∨

#1 BED ADDRESS	128
PRESS STOP TO EXIT	
NEXT	CHG ADDR
∨∨	∨∨

#36 DEFAULT SESSION VOLUME	5
PRESS STOP TO EXIT	
NEXT	CHG VOL
∨∨	∨∨

#37 DEFAULT IDLE VOLUME	3
PRESS STOP TO EXIT	
NEXT	CHG VOL
∨∨	∨∨

Guide to the Screens

Total Bed Hours - Displays total hours the unit has been used. This number is not adjustable.

Lamp Hours - Displays the number of hours the lamps have been on. This number can be reset to 0 when lamps are changed. You may also increase or decrease this number using the Body Fan buttons.

Bed Address - This is the T-Max® address used in salons with multiple beds and a T-Max® remote system. Use the Body Fan buttons to increase or decrease. (See *Setting the Address Manually* in Remote Connections.)

Default Session Volume - This is the volume the amplifier will automatically increase to when the unit is turned on. Adjust with the Body Fan buttons. The volume may also be adjusted during the session.

Default Idle Volume - This is the volume the radio will automatically decrease to when the unit shuts off and remains idle. Adjust with the Body Fan buttons.

Technical Information - Setting Operating Parameters

Below is an extended list of parameters which may be adjusted or viewed using the T-Max® manager. Refer to your T-Max® manual for complete instructions on how to view and adjust parameters.

Parameter	Function	Default
1	Unit Address (1-128)	1
2	Beep Mode (beep halfway through session) - 0=off, 1=on	0
5	Session Count (adjustable)	
6	Lamp Hours (adjustable)	
7	Bed Hours	
8	Manual Sessions (counts sessions in "stand-alone" mode)	
9	Clean Bed Indicator - 0 = off, 1 = on	1
14	Unit Beeps Every 5 Minutes - 0 = off, 1 = on	0
15	Master Session Count (not adjustable)	
19	Lockout "Stand-Alone" Sessions - 0 = off, 1 = on	0
23	Auto Continue (see last item in Troubleshooting) - 0=off, 1=on	0
31	Beep Frequency (2-255, higher numbers = lower frequency)	100
32	Beep Volume Offset (volume of beeps compared to music) 0 = -5 volume level, 10 = +5 volume level	5
36	Default Audio Volume High (during session)	5
37	Default Audio Volume Low (unit idle)	3
38	Face Tanner Re-light Delay (seconds)	60
255	Reset Factory Defaults	

Technical Information - Troubleshooting

<i>Problem</i>	<i>Solution</i>
Sunbed not tanning	<ol style="list-style-type: none"> 1. Clean sunbed, see <i>Thorough Periodic Cleaning</i>. 2. Ensure supply voltage is between 208 and 220V AC. 3. Replace lamps if lamp hours are greater than 700hrs. 4. Replace acrylic.
Lamps fail to light and timer display is blank	<ol style="list-style-type: none"> 1. Make sure the unit is connected to a power source. 2. Check source of AC power. Reset circuit breaker or replace fuse.
One or more lamps fail to light	<ol style="list-style-type: none"> 1. Check that lamp is installed correctly. 2. Switch unlit lamp with a lamp that lights, if new lamp lights and old lamp still does not, replace old lamp.
The face tanners will not come on	<ol style="list-style-type: none"> 1. Face tanner operation is initially delayed by a few seconds. 2. Face tanners will not relight for 60 seconds after being shut off. See <i>Setting Parameters</i> for more information. 3. Replace face tanner lamp, see <i>Removing/Replacing Face Tanner Lamps</i>.
The canopy will not stay up / The canopy will not stay down	Your sunbed uses a smooth gliding spring lift system to raise the canopy. This lift system may need to be adjusted slightly from time to time. See <i>Inside the Bench</i> for proper adjustment procedures. The canopy should raise easily as well as rest fully closed.
My canopy opens and closes too fast (slamming, not enough resistance)	Your sunbed utilizes a damper which limits the canopy's movement speed. This also serves as a safety device in case of spring lift failure as the canopy will not crash down. Replace the damper on back of unit.
Sunbed getting too hot	<ol style="list-style-type: none"> 1. Turn body fan on HI. 2. Ambient temperature of salon room must be below 80° at all times. 3. Check air filters. Change if dirty. 4. Input voltage, with unit running, must be less than 220VAC.
ERROR 92 The bed is off when it should be on	Current sensor indicating unit is off when it should be on. Contact servicer.

Technical Information - Troubleshooting

<i>Problem</i>	<i>Solution</i>
ERROR 93 The bed is on when it should be off	Current sensor indicating unit is on when it should be off. Contact servicer.
ERROR 98 Bed temperature exceeded	<ol style="list-style-type: none"> 1. Allow the unit to cool. 2. Check all fan openings and air filters for obstructions. 3. If problem persists, contact servicer.
I forgot what address I set my sunbed to (parameter 1)	By holding the body fan down button for 3 seconds the timer display will briefly display four numbers; the display version, the installed timer software version, the bed address and then a factory set timer code.
Timer display changes to indicate a tanning time after the timer button is pressed but lamps do not come on	<ol style="list-style-type: none"> 1. Bypass plug is not installed, see <i>Remote Connections</i>. 2. A non-SunStar® bypass has been used. See <i>Remote Connections</i>. 3. If remote is being used, other than T-Max® Manager, the external timer may not be activated. 4. Remote wiring is incorrect, see the instructions provided with the remote interface kit.
My bed is connected to the T-Max® Manager remote system and when the delay time has expired the timer display starts counting down but the bed lights do not come on	The auto start feature of the remote system is disabled, see the instructions provided with your remote system.
My bed won't work with the T-Max® Manager remote system	<ol style="list-style-type: none"> 1. The sunbed must first be set to a unique address, see <i>Remote Connections</i>. 2. The bypass or terminator plug may be installed in the series in an inappropriate location. Plug the bypass plug only into the bed at the end of the series.
I frequently disconnect my sunbeds from the T-Max® chain and interrupt the rest of the units	A T-Max® Inline 4-Pin Connector is available from ETS, Inc. which connects the chain without a sunbed.

Technical Information - Troubleshooting

<i>Problem</i>	<i>Solution</i>
Timer display continues to show the "welcome" screen after the timer button is pressed	<ol style="list-style-type: none"> 1. T-Max® Manager remote system has not yet been set. 2. Sunbed address is not set correctly, see <i>Remote Connections</i>.
My bed is connected to a T-Max® remote system but I am having trouble accessing parameter 1	You have probably attempted to connect your sunbed to the remote system already. Disconnect the remote plug(s) from the ports on the input box, wait 90 seconds and try again.
My bed, connected to a T-Max® Manager, did not display a delay time but does indicate: the "welcome" screen	<ol style="list-style-type: none"> 1. Remote device has not been set. 2. The sunbed has not been connected to the remote system, see <i>Remote Connections</i>.
a tanning time and the lamps have come on	<ol style="list-style-type: none"> 1. Delay time of T-Max® Manager has not been set. 2. Delay time has expired and session has begun.
a tanning time but the lamps have not come on	Auto start function of T-Max® Manager has been turned off. Press the timer button to turn on lamps.
When auto-addressing the first bed does not register an address	When using the auto address feature of the T-Max® Manager you must wait 10 seconds from the time you start the auto address function before addressing the first bed.
When using a T-Max® 1A my sunbed won't function properly	SunStar® Bypass plugs or terminator plugs may be needed if the T-Max® 1A and the sunbed are over 100 feet apart. Install the plugs in the open remote port in the sunbed and the T-Max® 1A.
My salon suffers frequent, short power outages and clients complain about losing session time	If you have a T-Max® Manager, changing parameter 23 from "0" to "1" will allow the tanning bed to remember how much time was left when power goes out and resume its session after power is restored. Consult your T-Max® Manager manual for information on setting parameters.

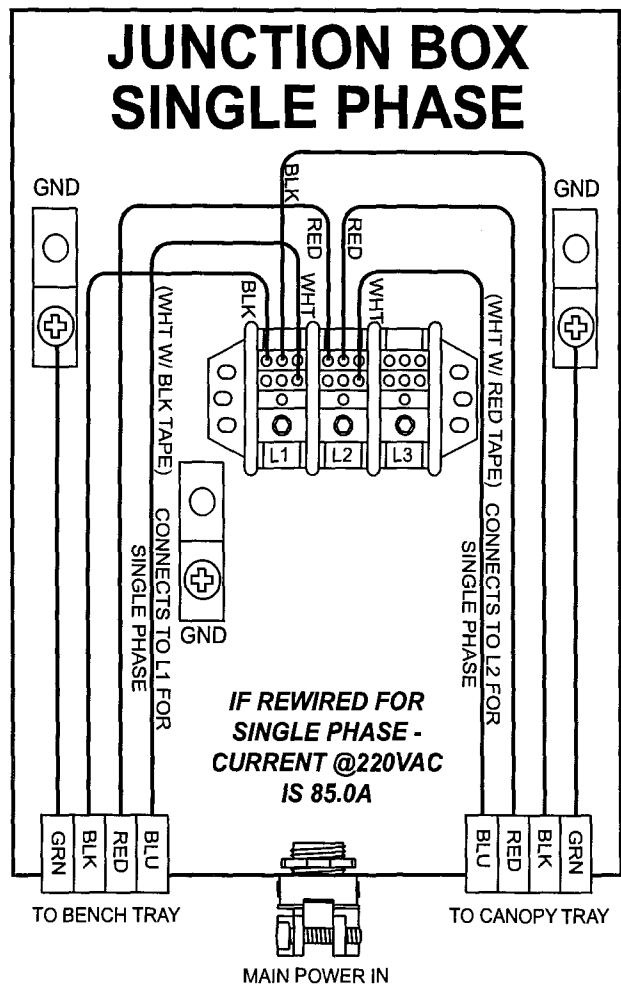
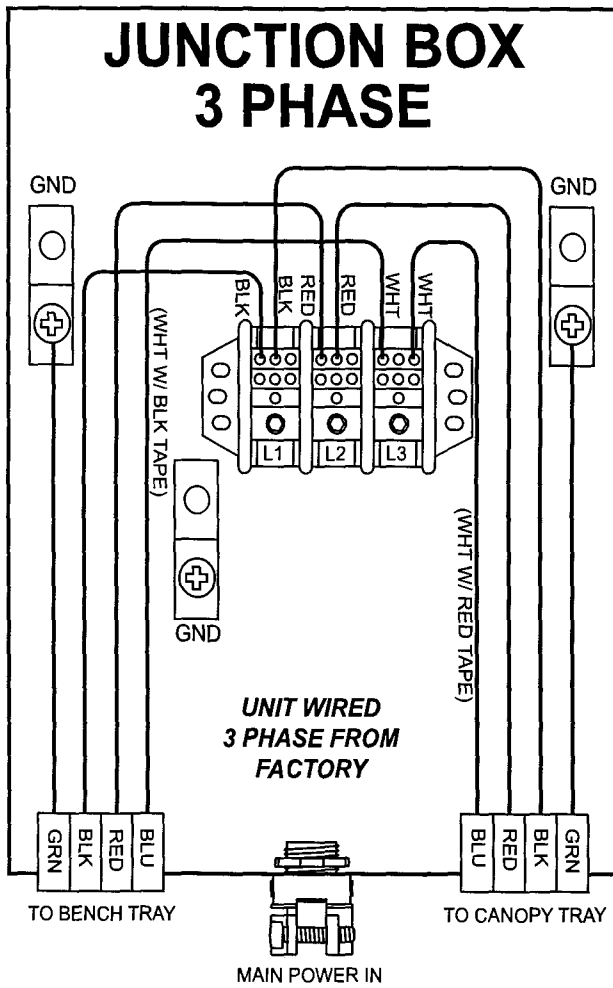

BUCKBOOSTER WIRE DIAGRAMS FOR THREE PHASE UNITS

BOOST OF +24 OR +32 VAC

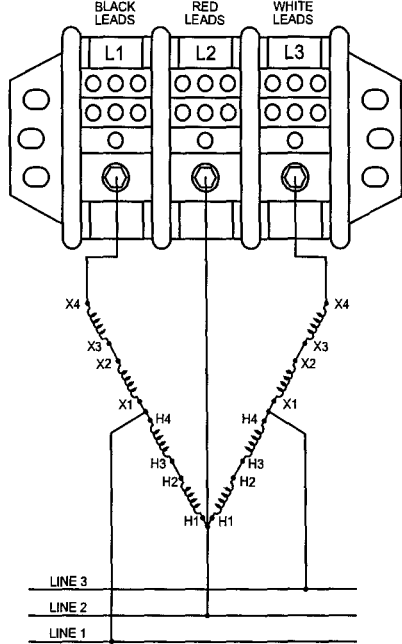

BOOST OF +12 OR +16 VAC

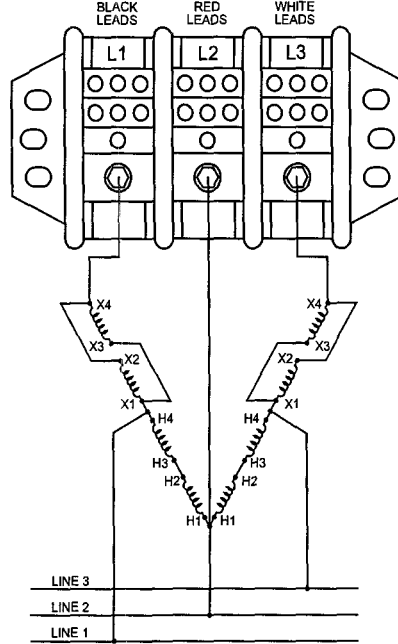

BUCK OF -24 OR -32 VAC

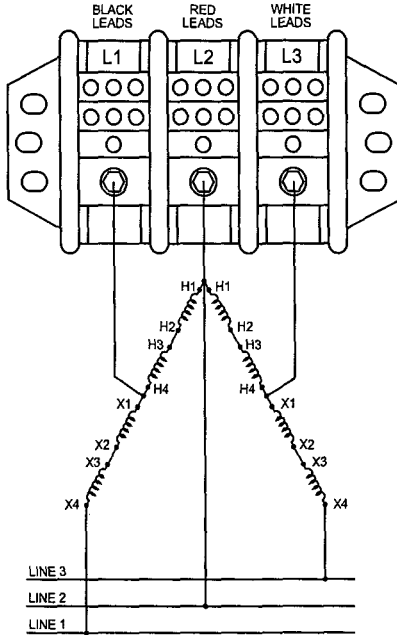

BUCK OF -12 OR -16 VAC

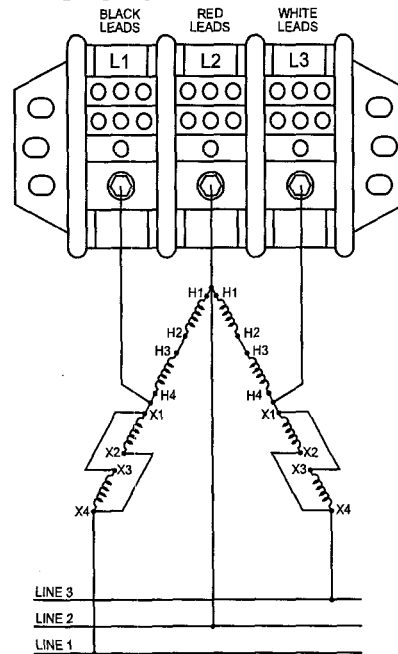

SS755

Size

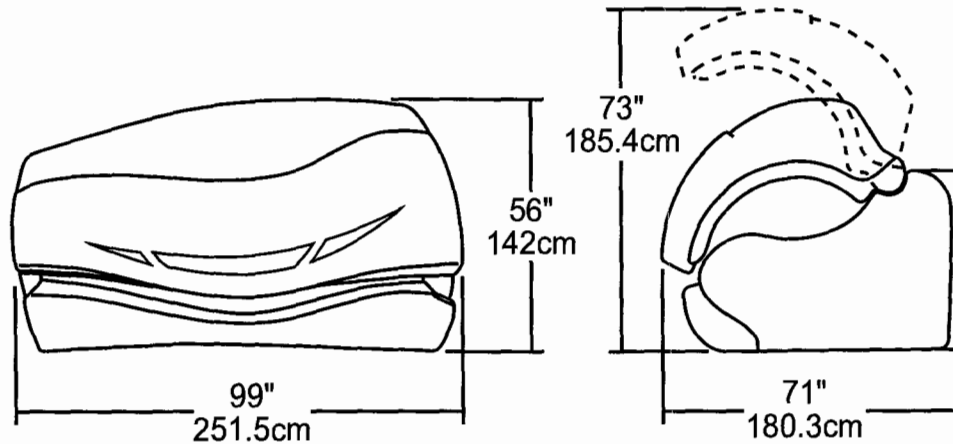

Weight	1431 lbs. (650 kg)
Recommended Room Size	10' x 10' (3m x 3m)
Electrical -	
Voltage (AC)	220
Amperage	49A 3-phase 85A 1-phase
Outlet	Sunbed hardwired Subwoofer requires standard 110VAC outlet
Main Lamps	55 x BRONZING SUN™ GOLD 200W
Face Tanner	5 x 500W (with low power option)
Shoulder Tanner	10 x 26W
Ballasts (main lamps)	200W
Body Cooling System	Full body cooling, directional face vents, foot fan
Speakers	2 x 80W 2-way speakers plus subwoofer
Timer System	Digital
Max. Exposure Time	10 minutes
Back-up Timer	Digital "watchdog" circuitry
Remote Capability	T-Max® compatible



Proudly manufactured
in the U.S.A.

