

USA

CND

EXPOSURE
20 min
TIME

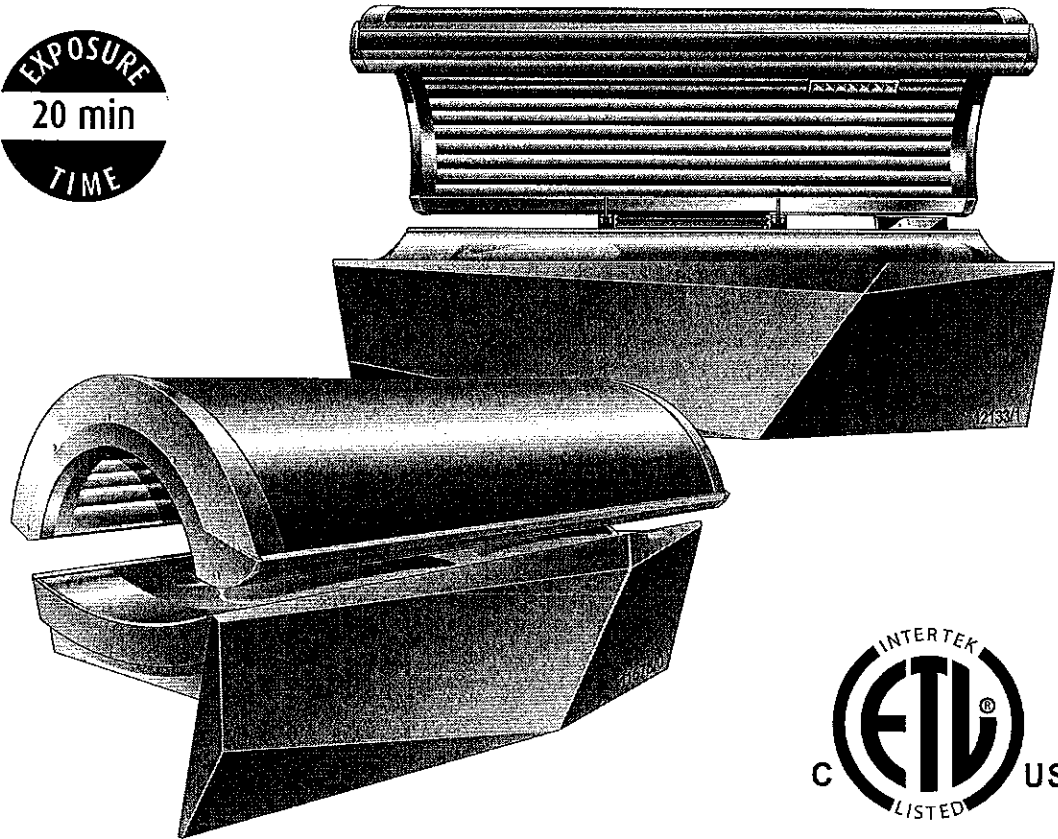

Operating instructions

Model-No.: JK 103/32-0

Ergoline SUNDASH 32 Super Power

Soltron XXS-35 SURF

Palm Beach Tan SIGNATURE

1008462-03 / us / 09.2015

JK NORTH AMERICA

Ergoline SUNANGEL BEAUTYANGEL soltron

Contact information

Manufacturer JK-Products GmbH



Köhlerhohner Straße
53578 Windhagen
GERMANY

Tel.: +49 (0) 22 24 / 818-140

Fax: +49 (0) 22 24 / 818-166

Customer Service JK Products & Services, Inc.



#1 Walter Kratz Drive
Jonesboro, AR 72401
800-445-0624

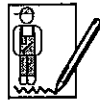

870-935-9046

<http://support.jkamerica.com>

⚠ WARNING!



WARNING!

Read these operating instructions.

Failure to observe these instructions:

- may result in serious injury and death,
- can result in damage to the device and the environment.
- For the safety of yourself and others, read and observe all instructions contained herein before operating the device.
- Please make the instructions and additional information available to anyone who operates or services the device.

Copyright

The copyright remains with JK-Holding GmbH.

The contents may not be duplicated (in whole or part), distributed or utilized for competition purposes without authorization or disclosed to other parties.

The right to make technical changes in regard to the figures and information contained in this instruction manual is reserved!

1 Table of Contents

2	What certain words and signs mean (Glossary)	6
2.1	Definitions	6
2.2	Warning signs	7
2.3	Symbols on the device	9
3	What this device is	11
3.1	Guidelines	11
3.2	Export	11
3.3	Scope of delivery	11
3.3.1	Optional	11
3.4	Device description	12
3.5	Options	13
3.6	Function description	13
3.7	Transport	14
3.8	Installation location	14
3.8.1	Ventilation	14
3.8.2	Setup location	15
3.8.3	Commissioning	16
3.9	Signs and stickers on the device	17
3.10	Technical data	24
3.10.1	Power rating, electrical specifications and noise level	24
3.10.2	Dimensions	25
3.10.3	Lamp configuration	26
3.10.4	Accent lighting	26
3.10.5	Spare parts	27
4	Why you use it	28
4.1	Intended use	28
4.2	Skin condition	28
5	Who cannot use it	29
5.1	Prohibited usage	29
5.1.1	Tanning system	29
5.1.2	Vibra Shape (vibration plate)	29
6	What you must do to avoid serious harm	30
6.1	General	30
6.2	Tanning system	30
6.3	Sensor	31
7	What you must do to avoid other harm	32
7.1	General	32
7.2	Tanning system	32
7.3	Sensor	32

7.4	Vibra Shape (vibration plate).....	32
7.5	Foreseeable misuse.....	33
7.6	Obligations of the studio operator.....	33
7.7	Staff training.....	33
8	Risks of using this device.....	34
9	Benefits of using this device.....	35
10	How to decide to use this device.....	36
11	What to do before the treatment.....	37
12	How to use this device.....	38
12.1	How to set this device up.....	38
12.2	How to make sure the device works.....	38
12.3	How to use it to treat your condition.....	38
12.4	How to choose correct treatment regimen.....	38
12.4.1	Skin types.....	38
12.4.2	Tanning times.....	39
12.5	How to operate the device.....	40
12.5.1	Control Center.....	40
12.5.2	User settings overview.....	40
12.6	Functions.....	41
12.6.1	Navigation.....	41
12.6.2	Description.....	42
12.7	Operating display of the sensor.....	42
12.8	Selection of the application.....	42
12.9	Sun Select setting with the outer interface.....	42
12.10	Measurement (automatic mode).....	42
12.11	Connections.....	42
12.12	How to use.....	43
12.12.1	How to start.....	43
12.12.2	Application tips.....	43
12.12.3	How to stop.....	44
12.13	What to do after the treatment.....	44
12.13.1	Cleaning and disinfection.....	44
12.14	Safety instructions for cleaning/ disinfection and maintenance.....	45
12.15	How to clean/disinfect.....	47
12.15.1	Cleaning and disinfection of surfaces.....	48
12.15.2	Cleaning/disinfection plan.....	49
12.16	How to maintain.....	50
12.16.1	Technical modifications.....	50
12.16.2	Maintenance plan.....	50
12.16.3	Cleaning and maintenance work preparation.....	53
12.16.4	Instructions for replacing the lamps.....	58
12.16.5	Cleaning and disinfection of the sensor.....	60

12.16.6	Cleaning or replacing UV lamps in the base	61
12.16.7	Cleaning or replacing the UV lamps in the side section	62
12.16.8	Cleaning or replacing UV lamps and filter panels in the canopy	62
12.16.9	Cleaning or replacing the UV lamps and filter panels in the shoulder tanner.....	63
12.16.10	Cleaning or replacing the interior lights	63
12.16.11	Cleaning or replacing the canopy accent lighting.....	63
12.16.12	Cleaning or replacing the front panel accent lighting	63
12.16.13	Cleaning the filters in the base.....	64
12.16.14	Cleaning the canopy filter mats.....	65
12.16.15	Cleaning the filter mats in shoulder tanner.....	65
12.16.16	Air conditioning: Empty the condensation tank and clean the filter.....	65
12.16.17	AQUA / AROMA SYSTEM maintenance.....	65
12.17	How to store the device.....	66
12.17.1	Decommissioning.....	66
12.17.2	Storage	66
12.17.3	Disposal	66
13	What to do when things go wrong.....	67
13.1	Troubleshooting	68
14	Where you can find out more.....	69
15	How we studied this device	70
16	Appendix.....	71
16.1	Model-No.: JK 103 / 32-0: EMC information.....	71
16.1.1	Table 201: Guidelines and manufacturer's declaration – Electromagnetic emissions	71
16.1.2	Table 202: Guidelines and manufacturer's declaration – Electromagnetic interference	72
16.1.3	Table 204: Guidelines and manufacturer's declaration – Electromagnetic interference	73
16.1.4	Table 206: Recommended safe distances between portable and mobile HF communications equipment and Model-No.: JK 103 / 32-0	74
17	JK-Products, Inc. – Limited Warranty	75
17.1	Limited Acrylic Warranty	76
17.2	Warranty Claims.....	76
17.2.1	Policy & Procedures.....	76
17.2.2	Labor Warranty Claim/Credit Procedures	77
17.3	Limited Lifetime Warranty	78
18	Index.....	81

2 What certain words and signs mean (Glossary)

2.1 Definitions

Studio operator

People who provide tanning devices to users on a commercial basis. The studio operator is trained to operate and maintain the device and is responsible for the orderly operation of the device as well as compliance with the maintenance intervals.

User

A person who uses the tanning device at a commercial location.

Staff

People who are responsible for the operation, cleaning/disinfection as well as general maintenance work and who instruct the users in the operation of the devices.

Authorized, trained and qualified staff

Qualified staff from an external company who have been trained and authorized by the manufacturer for assembly and maintenance work with specific devices.

Contraindications

Issues where the risk is always greater than the benefit and there are data supporting the risk and benefit relationship.

2.2 Warning signs

Danger notices, nonobservance will lead to death or serious injury:



 Type and source of danger, e.g. 'DANGER – High voltage!'

Description of the consequences, e.g. 'You can be killed or injured by an electric shock!'

Countermeasures:

- Disconnect device from power supply before opening.
- Do not reach into the inside with the device switched on.

Warning notices, nonobservance can lead to death or serious injury.



 Type and source of danger, e.g. 'WARNING – hot surface!'

Description of the consequences, e.g. 'You can burn your hand (skin, face)!'

Countermeasures:

- Do not touch hot parts and nearby surfaces.
- Wait until hot parts and surfaces have cooled down.

Warning notices, ultraviolet radiation, nonobservance can lead to serious injury:



 Type and source of danger, e.g. 'WARNING – ultraviolet radiation!'

Description of the consequences, e.g. 'You can burn your skin!'

Countermeasures, e.g.:

- Avoid overexposure.



 Crushing hazard, e.g. when closing the bed base!

Fingers can be jammed.

- Do not hold fingers between bed base and front panel.

Caution notices, nonobservance can lead to less than serious injury or damage of property.

 **CAUTION!**



Unauthorized lamps!

The word 'Caution' together with the warning sign points out that less than serious injury can be expected here.

Countermeasures:

- Avoid doing this.
- Do that.



ESD-sensitive components!

The word 'NOTICE' without warning sign points out that danger for devices, materials and the environment can be expected here.

Countermeasures:

- Avoid doing this.
- Do that.

Important information:



NOTE:

This symbol does not identify safety notices, but states information for a better understanding of the processes.

2.3 Symbols on the device

The following symbols are displayed on the device:



Manufacturer, production year and month



Type BF applied part¹



Follow Operating Instructions.

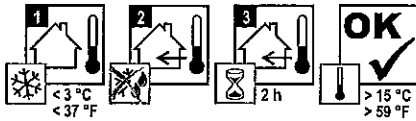

Where there are great differences in temperature between the transport route and the installation site the device may not be put into operation immediately after being set up.

Wait at least 2 hours before connecting the device to the power supply.

Maximum transport weight



Do not stack!



This side up.

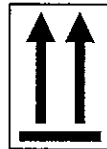

Keep dry.



Temperature limitations.

The temperature limits are noted next to the upper and lower horizontal line.



Recyclable material.



¹ Devices with physical contact between device and user belong to category BF (body float).

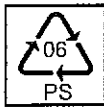

Polystyrene



Cardboard



Mixed paper



Steel



Wood

3 What this device is

3.1 Guidelines

This product is in conformity with the performance standards for sunlamp products under 21 CFR 1040.20, FDA and listed with ETL and CAN/CSA 22.2 No. 224.

3.2 Export

This device is exclusively intended for use in the USA and Canada and may not be exported to other countries and operated there! The manufacturer assumes no liability whatsoever in the event of non-compliance. High liability risks may occur for the exporter and/or the studio operator in the event of noncompliance.

3.3 Scope of delivery

- Tanning device
- Lamps
- Power cord
- Protective goggles
- Technical documentation (folder with instructions, brochures for error codes and default settings and additional documentation)

3.3.1 Optional

- Audio system (Stereo-Sound system)

3.4 Device description

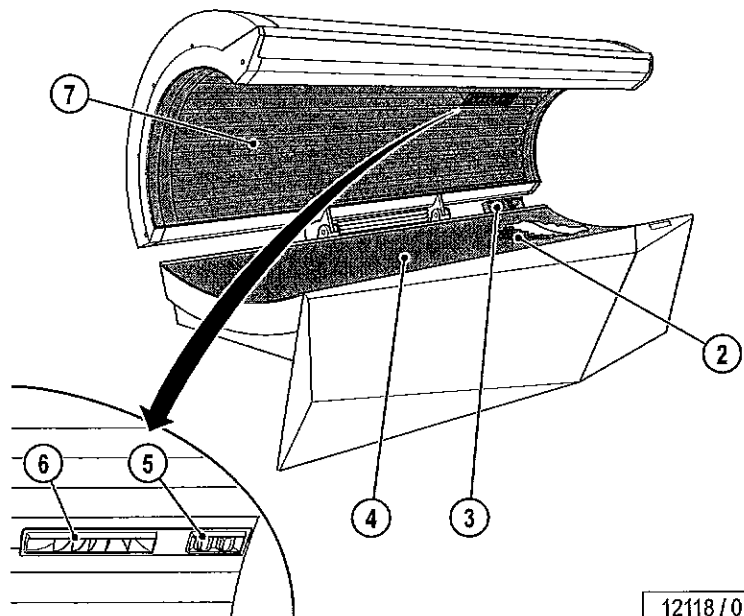

- 2. UV low pressure lamps, base
- 3. Operating panel
- 4. Acrylic panel base
- 5. Adjustable air nozzles – Facial cooling
- 6. Body cooling air nozzles
- 7. UV low pressure lamps, canopy

3.5 Options

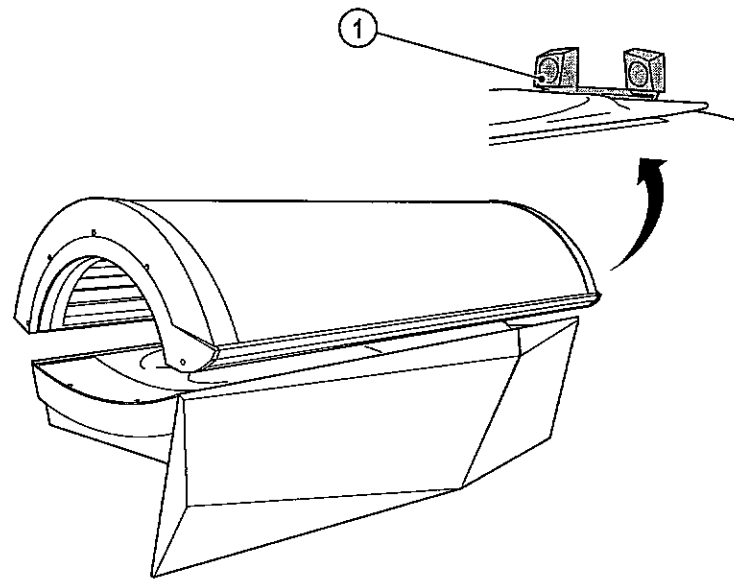

12119 / 1

1. Audio system (Stereo-Sound system)

3.6 Function description

The primary technical components of a tanning device are an artificial source of UV radiation, a variety of filters and reflectors as well as a mechanical structure with a defined active surface.

Different tanning results can be achieved in varying strength tanning devices. This is due to the different strength UV lamps and the different UV-A and UV-B proportions of the UV radiation. The UV-A proportion primarily generates a superficial tan, which appears rapidly and is intensive but also fades more rapidly, the UV-B radiation is primarily responsible for more long-term tanning results. The disadvantage of the UV-B radiation is that the tan does not become visible until one or two days after visiting the tanning salon. Therefore, the appropriate tanning device is to be selected depending on the desired tanning goal.

The tanning devices described here exclusively emit UV-A radiation.

3.7 Transport

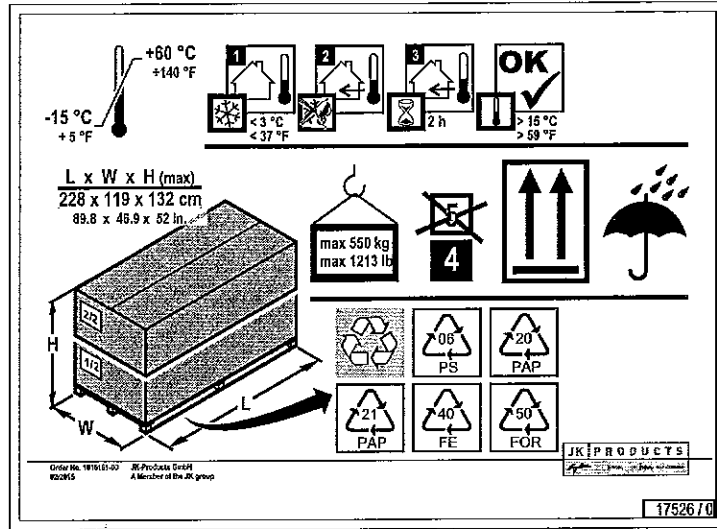

3.8 Installation location

You may find detailed information on installation and setting up in the Installation Instructions (see folder Technical Documentation).

3.8.1 Ventilation

Danger of failure!

Danger of overheating by obstruction of the air routing.

- Observe the ventilation information to avoid serious system malfunctions.

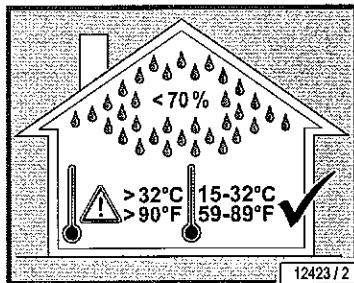

You can obtain data regarding the air supply and ventilation from the customer service department (see page 2).

3.8.2 Setup location

WARNING



WARNING!

Sudden movements and malfunctions!

Crushing hazard.

- The device is not suitable for operation in mobile facilities (ships, buses, trains). Adaptation of the unit is required in order to guarantee trouble-free operation when used in mobile facilities.

CAUTION!



Danger of overheating by obstruction of the air routing!

Any liability is excluded in case of damage or injury proven to be the result of the use of non-genuine spare parts.

Use of non-compliant lamps voids warranty and risks injury!

- Do not change, obstruct or block the air inflow and outflow area to the device or make any unauthorized changes to the device. The manufacturer shall bear no liability for damage or injuries resulting from such actions.
- Observe the ventilation information to avoid serious system malfunctions.
- Before putting a device into operation, the transport pallet must be removed from under the device. Danger of overheating by obstruction of the air routing.
- Maintain the minimum distances from the walls! Dimensions are given on page 25.
- Only use OEM spare parts of the same type! The use of other parts will void the manufacturer's warranty!

NOTICE

Salty air! Contaminated air!

Device damage due to corrosion of the housing and electrical components.

- Do not install the device at swimming pools.
- Do not operate the device in locations with aggressive environmental conditions (e.g. air containing chlorine).

Damage to the device possible!

Where there are great differences in temperature between the transport route and the installation site the device may not be put into operation immediately after being set up.

- Wait at least 2 hours before connecting the device to the power supply.

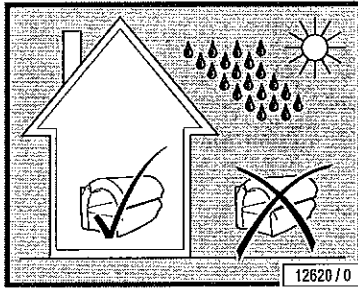

Damage to the device possible!

The device is not to be used outdoors.

Environmental conditions

- Optimum ambient temperature: Between 59 °F (15 °C) and 77 °F (25 °C)
- Storage temperature: Between 5 °F (-15 °C) and 140 °F (+60 °C)

Please contact the customer service department without fail before putting the device into operation - see page 2.

3.8.3 Commissioning



DANGER!

Damaged mains power cable!

Danger to persons through electric shock or burns.

- Only the manufacturer or specialist companies are permitted to replace the mains power cable.

Initial commissioning will be undertaken by the manufacturer's own service personnel or by authorized, trained and qualified staff. The device will be handed over ready for use.

As studio operator you are responsible for abiding by the electrical regulations applicable at the installation site.

The unit incorporates special preventive measures with regard to the electromagnetic compatibility and must be installed and commissioned according to the EMC instructions obtained from the assembly instructions.

If the device has not been used for a longer period of time, then it must first be inspected by our customer service department or by another authorized company before being put back into operation again.

3.9 Signs and stickers on the device

Signs which warn of danger areas or give important information on components are attached to the device. Ensure that the instruction signs are always clearly recognizable and easily legible. Any missing instruction signs or stickers must be replaced.

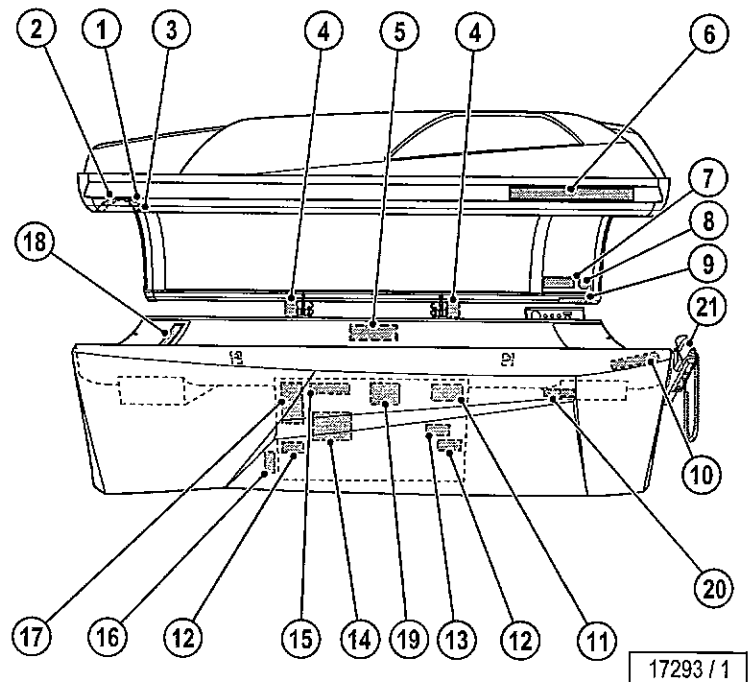

1: Name plate (example)

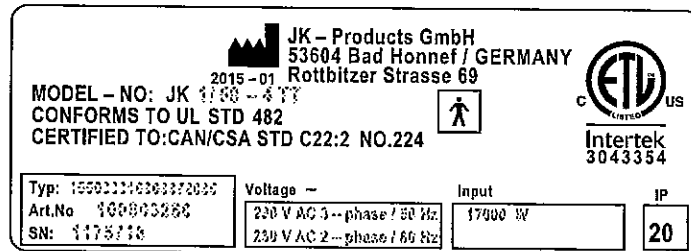

The name plate is attached to the interior side of the canopy. It contains important information for identifying the device (e. g. the serial number = Serial-No.) and the conformity mark.

2: Module plate (example)

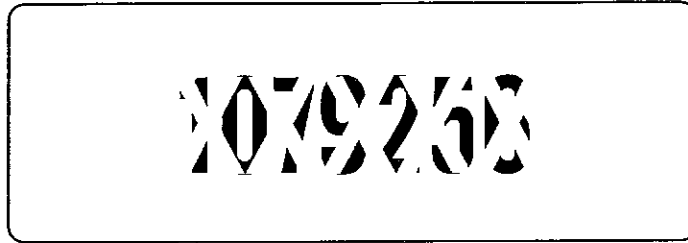

14434 / 0

3: Standards

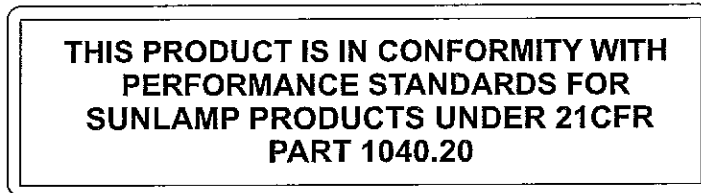

17292 / 0

4: Spring warning sticker (1014118-..)



17195 / 0

5: 'Remove lattice' sticker (842971-..)

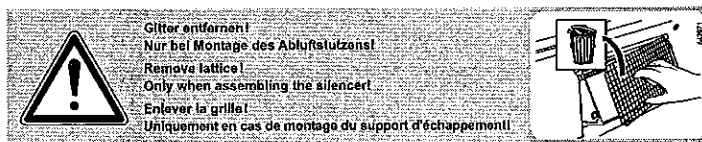

11978 / 0

The sticker is located at the rear on top of the air outlet.

6: Exposure label

DANGER ULTRAVIOLET RADIATION

Follow instructions. Avoid over-exposure as with natural sunlight. Over-exposure can cause eye and skin injury and allergic reactions. Repeated exposure may cause premature aging of the skin and skin cancer.

Maximum Tanning Time is 20 Minutes

Recommended Exposure Schedule					
Skin Type	Week 1 1st - 3rd Treatments	Week 2 4th - 6th Treatments	Week 3 7th - 10th Treatments	Week 4 11th - 15th Treatments	Weekly Subsequent Treatments
I - Sensitive	NOT ADVISED	NOT ADVISED	NOT ADVISED	NOT ADVISED	NOT ADVISED
II - Fair	3 Min.	7 Min.	15Min.	20Min.	20Min.
III - Average	3 Min.	7 Min.	15Min.	20Min.	20Min.
IV - Brown	3 Min.	10Min.	15 Min.	20Min.	20Min.
V - Dark Brown	3 Min.	10Min.	15 Min.	20Min.	20Min.

WEAR PROTECTIVE EYEWEAR! Failure to do so may result in severe burns or long term injury to the eyes.

Certain medications or cosmetics may increase your sensitivity to the ultraviolet radiation. Consult a physician before using sunlamps if you are using medication, have a history of skin problems or believe yourself to be especially sensitive to sunlight. If you do not tan in the sun, you are unlikely to tan from the use of this product.

This unit utilizes UVA lamps. Replace only with lamps of the product. **GENESIS HPR 20 FR70-112-CA-120 W (canopy)**, **GENESIS HPR 20 FR71-112-BA-120 W (base)** or recognized equivalents. To obtain the recommended exposure schedule position of a minimum distance of 1/2" (13 mm) measured with a standard ruler, lie on acrylic surface of lounge and lower canopy. Canopy will stop at the correct distance from lounge acrylic surface.

Warning: The use of any other position may result in overexposure!

Tanning can begin on a regular basis. An appearance of tanning normally appears after a few exposures and maximizes after four (4) weeks of exposure following the recommended exposure schedule for skin type. In order to provide for maintenance of a tan a maximum of two (2) weekly 20 minute sessions is recommended from the fifth week onward.

DO NOT TAN TWICE IN ONE DAY, ONLY TAN IN A 24 HOUR PERIOD.

Use protective eyewear, super sunnies, whenever unit is energized. Read and follow instruction booklet before using this product. To avoid electrical shock during maintenance disconnect power from unit. This product is in conformity with performance standards for sunlamp products under 21 CFR 104b.20, FOA.

Part No: 1008180-00

12116 / 1

The sticker is mounted on the canopy head end.

7: Warning sticker UV radiation (801140-..)

WARNING - ULTRAVIOLET RADIATION - FOLLOW INSTRUCTIONS - FAILURE TO USE PROTECTIVE EYEWEAR MAY RESULT IN SEVERE BURNS OR OTHER EYE INJURY - IF DISCOMFORT DEVELOPS, DISCONTINUE USE AND CONSULT A PHYSICIAN.

(I) As with natural sunlight, overexposure can cause eye injury and sunburn;

(II) Repeated exposure may cause premature aging of the skin and skin cancer;

(III) Medications or cosmetics applied to the skin, may increase sensitivity to ultraviolet light;

(IV) A person who does not tan in the sun most likely will not tan from the use of this device;

(V) A person having a history of skin problems should consult a physician before use;

(VI) Overexposure should be avoided; and

(VII) Children, the elderly, or fair skinned people who always burn easily and either never tan or tan minimally should not use this equipment.

(VIII) The appliance is not allowed to be used by more than one person at the same time.

ATTENTION - RAYONNEMENTS ULTRAVIOLETS - VEUILLEZ SUIVRE LES INSTRUCTIONS SUIVANTES - SANS DISPOSITIF DE PROTECTION DES YEUX, CE PRODUIT PEUT CAUSER DES BRULURES OU LESIONS OCULAIRES GRAVES - EN CAS DE PROBLEME ARRETER L'UTILISATION ET CONSULTER UN MEDECIN.

(I) Comme avec les rayons solaires naturels, une exposition trop longue peut causer coup de soleil ou brûlure;

(II) Une exposition répétée peut causer un vieillissement prématuré de la peau ou un cancer de la peau;

(III) L'utilisation de certains médicaments ou produits appliqués sur la peau peut accroître la sensibilité aux ultra-violet;

(IV) Les personnes ne bronçant pas au soleil ne le feront probablement pas sur cet appareil;

(V) Toute personne ayant des problèmes de peau doit consulter un médecin avant toute utilisation;

(VI) Eviter toute surexposition;

(VII) Il est conseillé aux enfants, aux personnes âgées ou aux personnes à peau claire ne bronçant pas ou étant très sensibles au soleil de ne pas utiliser cet appareil;

(VIII) L'appareil ne doit être utilisé que par une seule personne à la fois.



12076 / 1

8: Sticker 'Follow Operating Instructions' (1014232-..)



9: Sticker (1014367-..)

FOR SALES, SERVICE, LAMPS & LOTIONS
CALL:
800.643.0086
www.jkamerica.com

1014367-00-

17197 / 0

10: Age warning label (1508746-..)

ATTENTION: THIS SUNLAMP PRODUCT SHOULD NOT BE USED ON PERSONS UNDER THE AGE OF 18 YEARS.

17303 / 0

The sticker is mounted on the front panel.

11: CAUTION HIGH VOLTAGE sticker (1014186-..)



17471 / 0

12: Adjust canopy movement stickers (1014114-..)

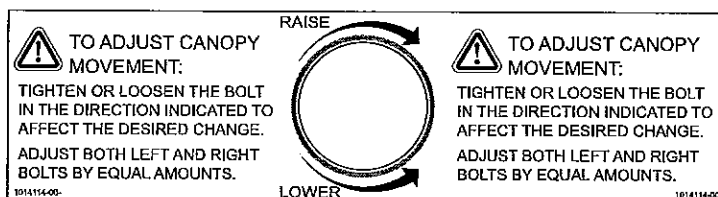

17470 / 0

13: Voltage is not switched off sticker (800698-..)

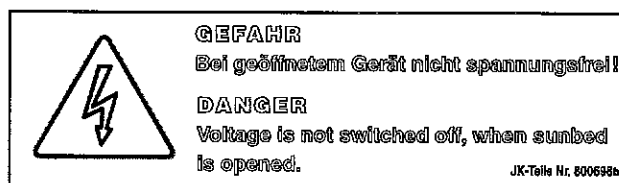

17516 / 0

14: Power unit components sticker (1505386-..)

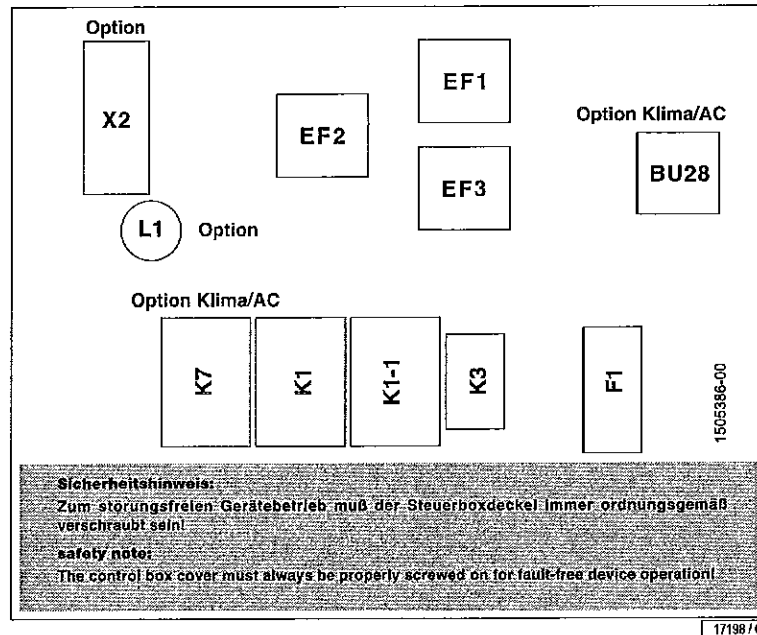

15: OEM parts sticker (801138-..)

ATTENTION!
Only use OEM certified replacement parts.
The use of other parts voids all
manufacturer's warranties and responsibilities.

801138-00

13513 / 0

The sticker is mounted on the bottom of the bed base.

16: Cable length warning sticker (1014119-..)

 TO ALLOW FOR SERVICE
AN EXCESS OF 10 IN. OF
CABLE SHOULD EXTEND
BEYOND THIS POINT!

1014119-00

17196 / 0

17: USA mains connection sticker (1504660-..)

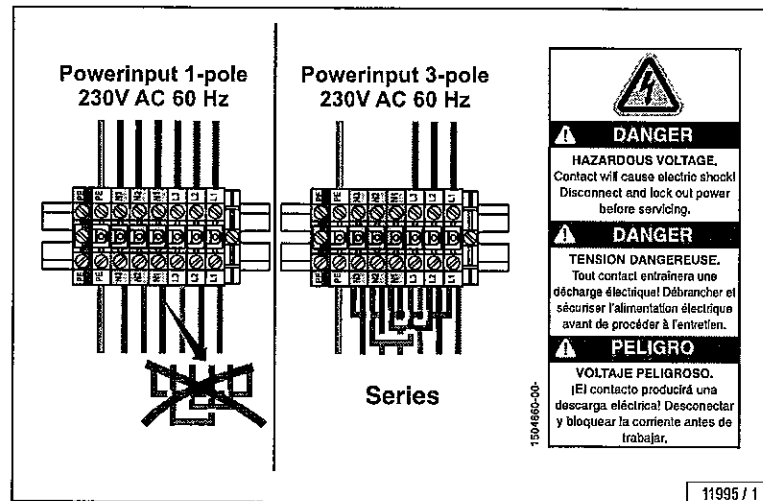

The sticker is mounted on the left side panel.

18: Lamp cover base sticker (801139-..)

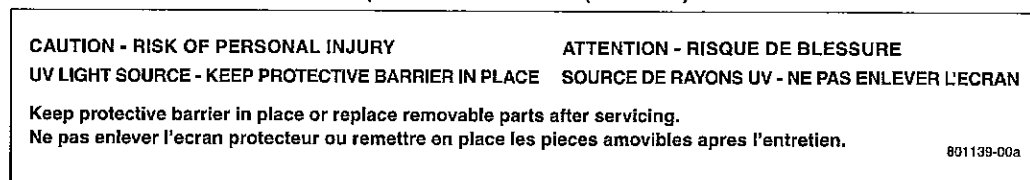

17192 / 0

The sticker is mounted on the lamp cover foot end.

19: Canada warning sticker (801371-..)

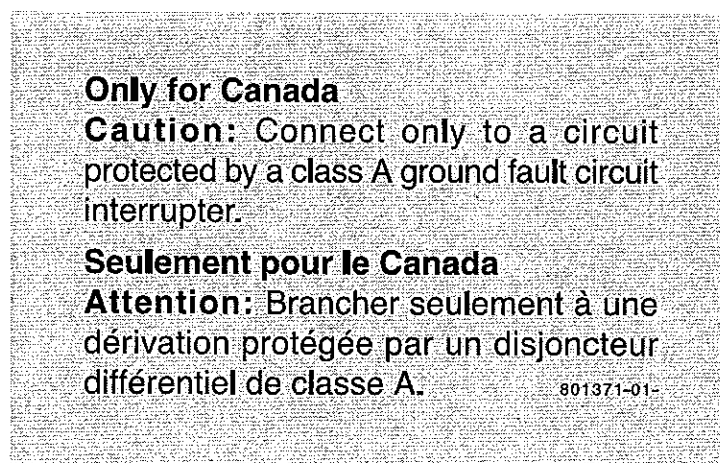

13514 / 0

20: Air conditioning sticker (1002243-..)

Not applicable for this device.

21: Warning sticker sensor base station (1009643-..)

Not applicable for this device.

3.10 Technical data

3.10.1 Power rating, electrical specifications and noise level

Model-No.: JK 103 / 32-0	
Power consumption rating:	5,000 W
Rated frequency:	60 Hz
Rated voltage:	230 V
Rated fuses:	20 amp 3-pole or 30 amp 2-pole
Classification:	Type BF applied part
Ingress protection classification:	IP20
Protection against electric shock:	Class I
Max. allowed network impedance:	0.095 Ω
Noise level 1m away from device:	66.0 dB(A)
Noise level inside the device:	< 81 dB(A)
Load on the acrylic panel:	max. 330 lb / 150 kg
Weight:	772 lb/350 kg
Max. humidity:	< 70%
Ambient temperature:	59-89 °F (15-32 °C)
Max. operating altitude (above sea level):	< 6500 ft (2000 m)



NOTE:

Adaptation of the unit is required for operating altitudes greater than 6500 ft / 2000 m above sea level in order to guarantee trouble-free operation.

3.10.2 Dimensions

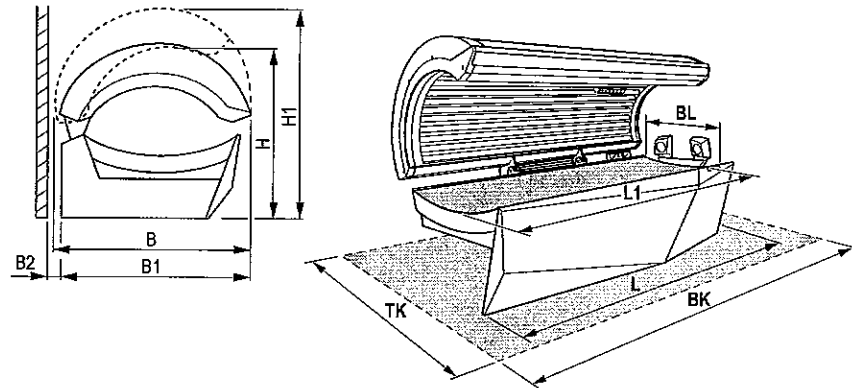

12122 / 2

B =	43 5/16 in	1,100 mm
B1 =	27 15/16 in	710 mm
H =	43 5/16 in	1,100 mm
H1 =	54 5/16 in	1,380 mm
L =	84 10/16 in (without Sound System)	2,150 mm (without Sound System)
L =	88 9/16 in (with Sound System)	2,250 mm (with Sound System)
L1 =	84 10/16 in	2,150 mm
BK =	94 1/2 in	2,400 mm
TK =	82 11/16 in	2,100 mm
B2 =	0 63/64 in	25 mm
BL =	33 15/32 in	850 mm

3.10.3 Lamp configuration

The use of other UV lamps and filter panels voids the operating license!

Model-No.: JK 103 / 32-0

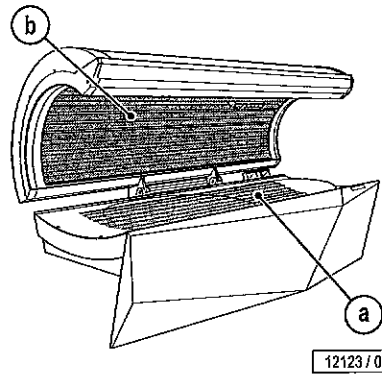

Lamp set

	Number	Description	Length	Power	Control	Order-no.
a)	14	UV low pressure lamps GENESIS HPR 20 FR71-T12-BA-120 W	71 in	120 W	120 W	1504557-..
	14	Starter 160 W				12637-..
b)	18	UV low pressure lamps GENESIS HPR 20 FR78-T12-CA-120 W	78 in	120 W	120 W	1504561-..
	18	Starter 160 W				12637-..

3.10.4 Accent lighting

Not applicable for this device.

3.10.5 Spare parts

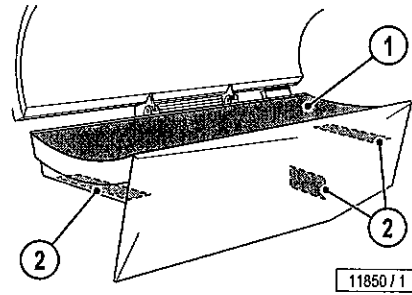

Number	Description	Order-no.
1	1 Acrylic panel	1504971-..
2	3 Filter	55567-..

For more spare parts, contact Customer Service (see page 2).

4 Why you use it

4.1 Intended use

This sunlamp product is intended exclusively for cosmetic tanning of the human skin, for one person at a time, at the age of 18 or above.

4.2 Skin condition

You may benefit from the use of this device

- if you tan in natural sunlight (skin types III, IV and V),
- if you have no acute sunburn or skin disease,
- if you take no medication or use cosmetics that may increase sensitivity to ultraviolet light.

Skin type I (Sensitive):

Invariably gets sunburn, accepts little natural sunlight and does not tan.

Skin type II (Fair):

Gets sunburn easily and severely, tans minimally or lightly and peels.

Skin type III (Average):

Often referred to as "Average" complexion, gets moderate sunburns and tans about average.

Skin type IV (Brown):

Seldom gets sunburns, tans easily and above average with each exposure.

Skin type V (Dark Brown):

This individual's system rarely gets sunburns, tans easily and substantially.



5 Who cannot use it

5.1 Prohibited usage

5.1.1 Tanning system



UV radiation
 Danger of skin and eye injuries or skin diseases!
 – Please observe the following instructions.

The following people must not use the device:

- People under 18 years of age
 - People with skin lesions or open wounds
 - People with acute sunburn
 - People who repeatedly suffered from serious sunburn during childhood
 - People with naturally red hair and pale skin
 - People with atypically discolored patches of skin
 - People who have or have had skin cancer
 - People who suffer from an increased risk of skin cancer (e.g. cases of skin cancer in the family)
 - People among whose closest relatives a melanoma has occurred
 - People who are being medically treated for photosensitivity
 - People taking photosensitivity causing medicine
 - People with freckles and people who tend to develop freckles
 - People with more than 16 moles on their body (2 mm diameter or larger)
 - People with atypical moles (atypical moles are, for example, asymmetrical moles with a diameter greater than 5 mm, with varying pigmentation and irregular edges)
- **Seek medical advice if in doubt!**

5.1.2 Vibra Shape (vibration plate)

Not applicable for this device.

6 What you must do to avoid serious harm

6.1 General



DANGER!

You can be killed or injured by an electric shock!

Assembly and electrical connection must comply with national and local regulations.

- The device may only be assembled, installed, upgraded or repaired by authorized, trained and qualified staff.

WARNING



WARNING!

Risk of electric shock!

- To avoid risk of electric shock, this equipment must only be connected to a mains supply with protective earthing.

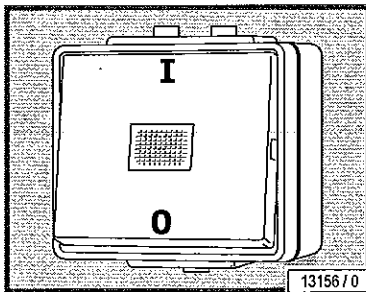

The electrical installation must have a freely accessible, all-pole disconnecting device (Master switch with clearly labelled On/Off settings, e.g. 'O' and 'I' or additional indicator light) fitted externally on the site side.



DANGER!

You can be killed or injured by an electric shock or injured by overexposure!

Skin damage and sunburn possible

Danger of overheating by obstruction of the air routing.

- No modification of this equipment is allowed.

6.2 Tanning system

WARNING



WARNING!

Unprotected tanning may result in eye injury and eye diseases!

The unprotected eye can become inflamed on the surface, and in certain cases the retina can be damaged by excessive radiation. Cataracts can form after repeated exposure to radiation.

- Inform users to use the included protective goggles that block UV.

WARNING!



Danger of ultraviolet radiation.

Ultraviolet radiation - follow instructions.

Failure to use protective eyewear may result in severe burns or other eye injury - if discomfort develops, discontinue use and consult a physician.

- As with natural sunlight, overexposure can cause eye injury and sunburn;
- Repeated exposure may cause premature aging of the skin and skin cancer;
- Medications or cosmetics applied to the skin, may increase sensitivity to ultraviolet light;
- A person who does not tan in the sun most likely will not tan from the use of this device;
- A person having a history of skin problems should consult a physician before use;
- Overexposure should be avoided; and
- Children, the elderly, or fair skinned people who always burn easily and either never tan or tan minimally should not use this equipment.
- The appliance is not allowed to be used by more than one person at the same time.

WARNING!



WARNING!

Danger of long-term consequences!

Exposure to ultraviolet radiation may increase the likelihood of developing skin cancer and cause serious eye injury. You do not need to become tan to make Vitamin D.

- Overexposure should be avoided.
- Children may not use this device.

- Seek medical advice if in doubt!

6.3 Sensor

Not applicable for this device.

7 What you must do to avoid other harm

7.1 General

⚠ WARNING



Infections can be transferred through skin contact.

All items/equipment components, with which the user can come into contact during tanning, must be cleaned and disinfected

after every tanning session:

- Protective goggles
- Acrylic panel
- Handles and control panel
- MP3 cable
- Adjustable air nozzles
- Use only EPA registered quaternary ammonium germicidal based detergent solution (follow product label for use-dilution), such as Lucasol One Step, to clean and disinfect the tanning system and its components.

7.2 Tanning system

⚠ WARNING



Danger of long-term consequences!

- Overexposure should be avoided.
- The elderly should not use this equipment.
- Children may not use this device.
- While there is no immediate clinical evidence of UVA exposure and its effects upon expectant mothers, it is strongly advised that expectant mothers be discouraged from using the tanning unit.

7.3 Sensor

Not applicable for this device.

7.4 Vibra Shape (vibration plate)

Not applicable for this device.

7.5 Foreseeable misuse

The following uses of the device are explicitly prohibited:

- Only one person at a time may use the device.
- People with body weight of more than 330 lb (150 kg) may not use the device.
- Exceeding the specified tanning times may result in burns and long-term skin damage.
- When the device is in use no other people may remain in the room. This includes both children and adults.

7.6 Obligations of the studio operator

- As the studio operator you are responsible for informing users on possible risks of tanning.
- All danger and safety labels attached to the device must be observed! Do not remove them!
- No safety equipment (e.g. panel switch) may be removed, deactivated, or otherwise bypassed as it can impair the safe operation of the device!
- The device may only be used when in completely operational condition!
- It is the studio operator's responsibility to ensure the tanning system is handled properly.

7.7 Staff training

As studio operator you are obligated to train your personnel and instruct them in the established legal and accident prevention regulations. Ensure that your staff have understood and observe these instructions. This includes:

- information regarding intended use and foreseeable misuse
- safety instructions
- operating instructions
- cleaning/disinfection and maintenance instructions
- Please make the instructions and additional information from the manufacturer available to the staff at their workplace.
- Regularly check your staff's safety consciousness and awareness of the risks, taking into account your operating instructions.
- Please ensure that the cleaning/disinfection intervals are complied with, in particular cleaning and disinfection after every use.
- Please ensure that your staff provide your customers with appropriate advice, in particular regarding tanning times, possible risks and the operation of the device.

8 Risks of using this device



⚠ WARNING!

Danger through ultraviolet radiation!

Danger of skin and eye injuries or skin diseases!

- This sunlamp product must not be used on individuals who have had skin cancer or have a family history of skin cancer.
- Persons repeatedly exposed to ultraviolet sunlamp products must be evaluated for skin cancer regularly.
- This sunlamp product must not be used by people among whose closest relatives a melanoma has occurred.

Contraindications! The following people must not use this system:

- People under 18 years of age
- People with skin lesions or open wounds
- People with acute sunburn
- People who repeatedly suffered from serious sunburn during childhood
- People with naturally red hair and pale skin
- People with atypically discolored patches of skin
- People who have or have had skin cancer
- People who are being medically treated for photosensitivity
- People taking photosensitivity causing medicine
- People with freckles and people who tend to develop freckles
- People with more than 16 moles on their body (2 mm diameter or larger)
- People with atypical moles (atypical moles are, for example, asymmetrical moles with a diameter greater than 5 mm, with varying pigmentation and irregular edges)

9 Benefits of using this device

This device serves the purpose of cosmetic tanning for one adult person with skin suitable for tanning.

Different tanning results can be achieved in varying strength tanning devices. This is due to the different strength UV lamps and the different UV-A and UV-B proportions of the UV radiation. The UV-A proportion primarily generates a superficial tan, which appears rapidly and is intensive but also fades more rapidly, the UV-B radiation is primarily responsible for more long-term tanning results.

10 How to decide to use this device

This device is intended only for commercial use and not for private use.

Some people are not permitted to use the device, see chapter 5.

The device may not be used by people with reduced physical, sensory or mental capabilities or who have insufficient experience and/or knowledge without supervision. A person responsible for their safety must ensure, either by supervision or instruction, that the device is used correctly and safely. If there is any doubt, use of the device by such categories of persons is to be forbidden!

11 What to do before the treatment

Please check for any conditions that may prohibit the use of this device – see chapters 5, 6, 8, 10.

Make-up in the tanning device

Please do not wear make-up. Clean skin absorbs UV light better.

A wide variety of materials is found in cosmetics. Whether these are emulsifiers, greases, or fragrances - in conjunction with UV radiation, these can cause skin allergy reactions.

Remove all make-up. This is essential. Make-up clogs the pores in the face. The UV light from a tanning device re-opens these clogged pores so that not only does the light penetrate the skin, but also the allergenic components of the make-up.

A further negative consequence of make-up is that the appearance of the skin deteriorates irreversibly over a period of time. However good make-up looks - in conjunction with UV light, it causes more harm than good. Therefore remove all make-up before a session in your tanning device - it will be much better applied afterwards.

- Remove all jewelry (including piercings) prior to the application.
- Remove cosmetics before using the device and do not use sun screen products.

Are medications and the tanning device compatible?

It is known that some medications increase the skin's sensitivity to UV light. This probability is particularly high with antibiotics, sulphonamides, psychiatric drugs, tranquillizers, anti-diabetes treatments and diuretics. Sun creams which contain psoralen or kumarin also increase skin sensitivity. If you are in any doubt, first ask your doctor - then you can enjoy the sun at no risk.

Contact lenses in the tanning device?

The answer is: Yes! Like any other tanning device user, contact lens wearers should also wear special protective goggles which protect the eyes against UV radiation. To guarantee better protection, wearers of glasses and contact lenses can ask their optician for exchange contact lenses with UV protection.

This will benefit tanning device users not only in the open air, but on the tanning device itself. You can wear these contact lenses on the tanning device without any restrictions. For more information, ask your optician or optometrist.

Showering after leaving the tanning device?

The browning is in the skin, not on it. Therefore you cannot wash it off. Treat your skin to a moisturizing cream after showering.

12 How to use this device

12.1 How to set this device up

After commissioning and cleaning/disinfection, the device is ready for operation.

12.2 How to make sure the device works

Before using the device, check for damage to filter panels and acrylic panels.

12.3 How to use it to treat your condition

- No other persons are permitted in the vicinity of the cabin when using the device, this especially applies to children.
- UV light can cause irreversible skin or eye damage. The unprotected eye can become inflamed on the surface, and in certain cases the retina can be damaged by excessive radiation. Cataracts can form after numerous repeated tanning sessions. **Use the UV-impermeable protective goggles provided** (order no. 84592-..). Contact lenses and sun glasses are no substitutes for protective glasses.
- Always comply with the recommended application times.

12.4 How to choose correct treatment regimen

12.4.1 Skin types

Skin type I (Sensitive):

Invariably gets sunburn, accepts little natural sunlight and does not tan.



Skin type II (Fair):

Gets sunburn easily and severely, tans minimally or lightly and peels.



Skin type III (Average):

Often referred to as "Average" complexion, gets moderate sunburns and tans about average.



Skin type IV (Brown):

Seldom gets sunburns, tans easily and above average with each exposure.

Skin type V (Dark Brown):

This individual's system rarely gets sunburns, tans easily and substantially.

12.4.2 Tanning times



NOTE:

The tanning times given in the table must not be exceeded!

DANGER ULTRAVIOLET RADIATION

Follow instructions. Avoid over-exposure as with natural sunlight. Over-exposure can cause eye and skin injury and allergic reactions. Repeated exposure may cause premature aging of the skin and skin cancer.

Maximum Tanning Time is 20 Minutes

Recommended Exposure Schedule					
Skin Type	Week 1 1st - 3rd Treatments	Week 2 4th - 6th Treatments	Week 3 7th - 10th Treatments	Week 4 11th - 15th Treatments	Weekly Subsequent Treatments
I - Sensitive	NOT ADVISED	NOT ADVISED	NOT ADVISED	NOT ADVISED	NOT ADVISED
II - Fair	3 Min.	7 Min.	15Min.	20Min.	20 Min.
III - Average	3 Min.	7 Min.	15Min.	20Min.	20 Min.
IV - Brown	3 Min.	10Min.	15 Min.	20Min.	20 Min.
V - Dark Brown	3 Min.	10Min.	15 Min.	20Min.	20 Min.

<p>WEAR PROTECTIVE EYEWEAR! Failure to do so may result in severe burns or long term injury to the eyes.</p> <p>Certain medications or cosmetics may increase your sensitivity to the ultraviolet radiation. Consult a physician before using sunlamps if you are using medication, have a history of skin problems or believe yourself to be especially sensitive to sunlight. If you do not tan in the sun, you are unlikely to tan from the use of this product.</p>	<p>This unit utilizes UVA lamps. Replace only with lamps of the product. GENESIS HPR 20 FR78-112-CA-120 W (canopy), GENESIS HPR 20 FR71-112-BA-120 W (base) or recognized equivalents. To obtain the recommended exposure schedule position of a minimum distance of 1/2" (13 mm) measured with a standard ruler, lie on acrylic surface of lounge and lower canopy. Canopy will stop at the correct distance from lounge acrylic surface.</p> <p align="center"><small>Warning: The use of any other position may result in overexposure!</small></p>
--	---

<p>Tanning can begin on a regular basis. An appearance of tanning normally appears after a few exposures and maximizes after four (4) weeks of exposure following the recommended exposure schedule for skin type. In order to provide for maintenance of a tan a maximum of two (2) weekly 20 minute sessions is recommended from the fifth week onward.</p> <p>DO NOT TAN TWICE IN ONE DAY, ONLY TAN IN A 24 HOUR PERIOD.</p>	<p>Use protective eyewear, super sunnies, whenever unit is energized. Read and follow instruction booklet before using this product. To avoid electrical shock during maintenance disconnect power from unit. This product is in conformity with performance standards for sunlamp products under 21 CFR 1040.20, FDA.</p> <p align="right"><small>Part No: 1008180-00</small></p>
--	--

12116 / 1

The sticker is mounted on the canopy head end.

12.5 How to operate the device

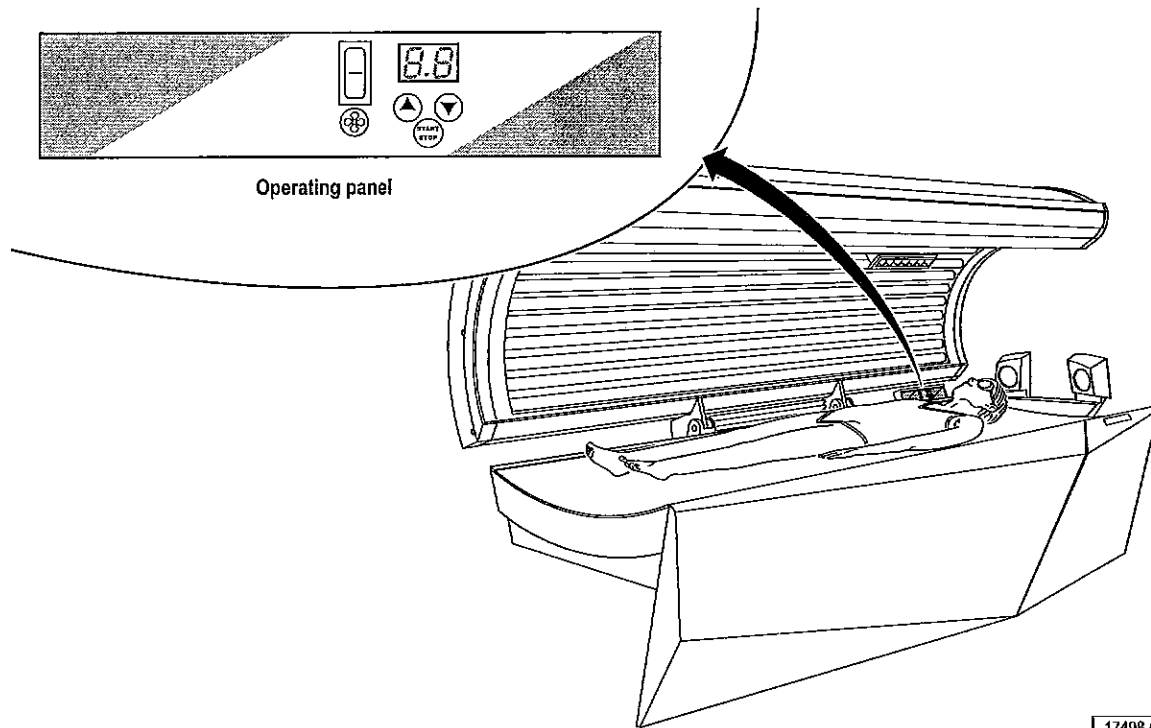

Operating panel

17498 / 0

12.5.1 Control Center

Not applicable for this device

12.5.2 User settings overview

Not applicable for this device.

12.6 Functions

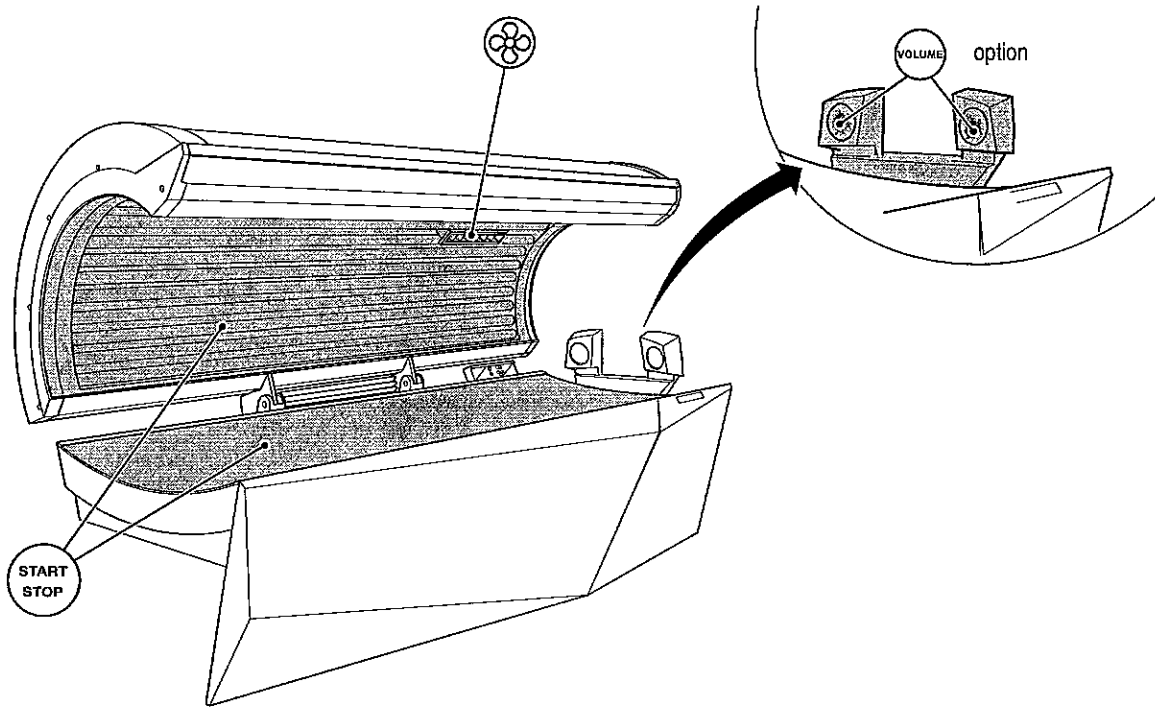

12120 / 2

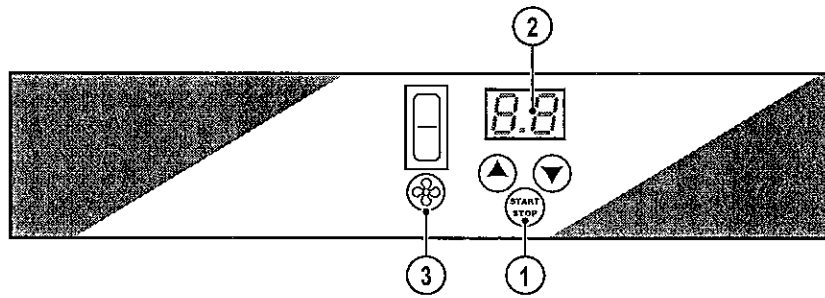





17524 / 0

12.6.1 Navigation

Not applicable for this device.

12.6.2 Description

Function	Button sequence	Description	Information
1. UV lamps		START/STOP Switch the UV lamps on / off during tanning	
3. Body cooling/ Facial cooling	 	Control cooling, Levels 1-2 Switch off cooling Switch on cooling	 The air jets for the facial cooling can be adjusted by hand.
2. Time		Set tanning time	

12.7 Operating display of the sensor

Not applicable for this device.

12.8 Selection of the application

Not applicable for this device.

12.9 Sun Select setting with the outer interface

Not applicable for this device.

12.10 Measurement (automatic mode)

Not applicable for this device.

12.11 Connections

Not applicable for this device.

12.12 How to use



NOTE:

Before use the device must always be cleaned and disinfected! See chapter 12.15 'How to clean/disinfect'.

12.12.1 How to start

The device is started automatically with an internal or external timer.



NOTE:

See separate document 'Timer Control Module' #1008370-.. in the Technical Documentation folder.

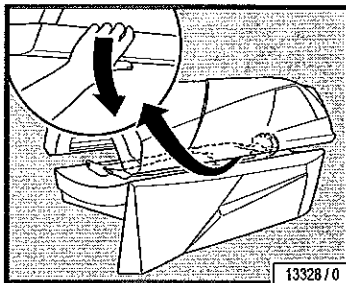

Preparation time

Before the UV lamps turn on, you have a few minutes to prepare yourself. During the preparation time you can switch on the UV lamps at any time by pressing the START/STOP button.

- Remove your clothes and all jewelry.
- Remove make-up and other cosmetics.
- Remove glasses. Contact lenses can be worn under the protective goggles.
- Put on the protective goggles.
- Lie down on the bed surface.
- Close the canopy.
- Press the START/STOP button.

Settings on start-up:

- UV lamps
- Body cooling
- Face cooling

12.12.2 Application tips

When describing the operation, the tanning device is often shown with the canopy open. During tanning the canopy must always be closed.

Proper operation is not possible with the canopy open.

- Lie down and place your head on the headrest or as indicated by the ergonomic base panel to maintain the proper distance between skin and lamps.

12.12.3 How to stop

The tanning session ends automatically after the preset time has run down. The internal body cooling fan continues to run for approx. three (3) minutes to sufficiently cool the device.

- To interrupt a tanning session, press and hold button START/STOP any-time during a session.
- Press START/STOP again to restart the lamps.

12.13 What to do after the treatment

12.13.1 Cleaning and disinfection



WARNING!



WARNING!

Infections can be transferred through skin contact.

All items/equipment components, with which the user can come into contact during tanning, must be cleaned and disinfected after every tanning session:

- Protective goggles
- Acrylic panel
- Handles and control panel
- MP3 cable
- Adjustable air nozzles
- Use only EPA registered quaternary ammonium germicidal based detergent solution (follow product label for use-dilution), such as Lucasol One Step, to clean and disinfect the tanning system and its components.



NOTE:

For thorough cleaning and disinfection, the product must be allowed to remain in contact with the surface being cleaned and disinfected for a specified amount of time.

This specified amount of time depends on the cleaner/disinfectant which is used. Follow the directions for use of the cleaner/disinfectant.

After this specified application time remove remaining cleaner/disinfectant from the surfaces of the device. Use a single-pass paper towel.

12.14 Safety instructions for cleaning/ disinfection and maintenance



You can be killed or injured by an electric shock!

During maintenance and service work there is a risk of touching live parts and receiving a fatal electric shock.

- The device must not be in use.
- Disconnect device from power supply before opening.
- Do not reach behind covers and do not open the device with the device switched on.
- Refit any safety devices (e.g. switches) after the work has been completed.

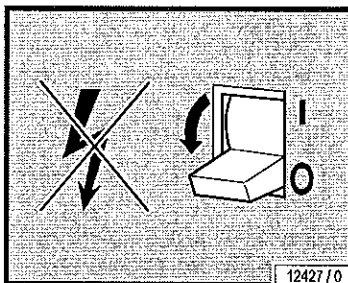

12427 / 0

If work is to be performed on the devices, they must be deenergized. That means that all live cables must be switched off.

Switching off the device alone is insufficient, as certain points may remain energized. Therefore, switch off fuses before performing any work and – if possible – remove them.

Accidental reactivation can result in serious accidents. Immediately after deenergizing, secure all switches or fuses used for deenergizing against being switched on again.

- Lock the fuse box with a padlock.

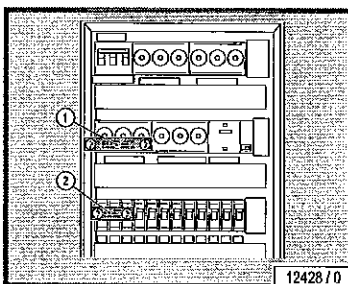

12428 / 0

In case of circuit breakers which cannot be unscrewed, a strip of adhesive tape may be applied over the actuation lever (1 + 2) with the wording 'Do not switch, danger!'.

A prohibition sign with the text:

'Work in progress!'

'Place:

'Sign may only be removed by:

must always be securely mounted immediately.

It is imperative that you, the owner and/or studio operator, check all components for any signs of wear which may occur through normal use.

- Observe the cleaning/disinfection and maintenance schedule specified in the tables in Chapter 12.15.2 and 12.16.2.
- Only replace UV low-pressure lamps with the original type or compatible lamps.

Should you require any assistance or need additional information, please call Global Service USA at 800 445 0624, Monday through Friday 8:00 a.m. - 7:00 p.m. CT, Saturday 8:00 a.m. to 3:00 p.m.



NOTE:

The service of the device may only be carried out by authorized, trained and qualified staff.

! WARNING!



WARNING!

Injuries and damage due to improper maintenance!

If the maintenance intervals for the UV lamps are exceeded or incompatible UV lamps are installed, the share of harmful UVB radiation may increase. Sunburn and other skin damage may result.

Improper maintenance can cause the device to be damaged or to become unusable.

- Always comply with the specified maintenance intervals, see chapter 12.16.2 Maintenance plan.
- Follow the cleaning/disinfection instructions.

Danger of burns from hot lamps and device parts!

If the tanning device was operated before being switched off and opened, lamps and housing parts may be hot.

- Before replacing lamps or other spare parts, wait until lamps and metal parts of the device have cooled down sufficiently.

Danger of squeezing!

When opening and closing the panels and acrylics, you can squeeze your fingers.

Maintenance and care play a major role in deciding the devices performance and appearance over its useful life. Diligent compliance at the specified intervals is absolutely necessary to ensure the proper operation of your device.

The current operating hours of the parts requiring maintenance can be displayed in the Presetting mode – see separate instructions 'Presettings' #1011803-.. in the Technical Documentation folder.

Please note that the device must be inspected regularly by a JK authorized representative every 12 months (from date of installation) to maintain its proper condition!

Acrylic panel

! NOTICE!

Cosmetics may cause cracks to form on the surface!

Over the long-term cosmetics or sunscreens cause damage (e.g. crack formation on the surface).

- Ensure that cosmetics and sunscreens are removed before tanning.
-

The acrylic panels for the tanning devices are produced of acrylic glass developed especially for this application. The acrylics used feature a particularly high UV permeability and resistance, as well as an easy-care, hygienic surface that is gentle on the skin.

The acrylic panels are formed to device-specific shapes in a technically complex production process. Despite state-of-the-art production know-how, the presence of minor spots, air bubbles or streaks in the acrylic panels is unavoidable. In addition, hairline cracks can occur on the acrylic panel during operation.

These occurrences are material-related and are unavoidable in processing. However, they have no significant effect on use and are therefore not accepted as defects.

Over the course of time the acrylic panel will become discolored as a result of usage and must be replaced by customer-service personnel on a regular basis.

The optional partition (only for devices with an air conditioning unit) works as a UV filter and must be replaced by customer-service personnel on a regular basis.

12.15 How to clean/disinfect



WARNING!

Infections can be transferred through skin contact.

All items/equipment components, with which the user can come into contact during tanning, must be cleaned and disinfected after every tanning session:

- Protective goggles
- Acrylic panel
- Handles and control panel
- MP3 cable
- Adjustable air nozzles
- Use only EPA registered quaternary ammonium germicidal based detergent solution (follow product label for use-dilution), such as Lucasol One Step, to clean and disinfect the tanning system and its components.



NOTE:

For thorough cleaning and disinfection, the product must be allowed to remain in contact with the surface being cleaned and disinfected for a specified amount of time. This specified amount of time depends on the cleaner/disinfectant which is used. Follow the directions for use of the cleaner/disinfectant. After this specified application time remove remaining cleaner/disinfectant from the surfaces of the device. Use a single-pass paper towel.

12.15.1 Cleaning and disinfection of surfaces

Acrylic panel

Do not rub with a dry cloth – danger of scratching!

- Other cleaning agents, especially concentrated disinfectants or solvents (e.g. Lysoform, ethyl alcohol or other liquids containing alcohol) must never be used for cleaning. **Failure to observe this voids all warranty claims.**

Acrylic panels (4) & (7) referenced in section 12.15.2 'Cleaning/ disinfection plan'

These two panels are not in direct contact with the user, however they can become soiled if the user inadvertently touches them. If these panels are left soiled for an extended period of time, the heat and light from the tanning lamps may cause the soiled areas to become permanently stained. Therefore we recommend frequently inspecting and cleaning these panels when necessary, to ensure the serviceable life of the acrylic.

- Remove fingerprints and other soiling carefully.

Plastic surfaces

For cleaning the remaining painted and unpainted plastic surfaces, it is best to simply use warm water and a commercially available soft chamois leather. Never use aggressive cleaning agents containing alcohol or essential oils. These may lead, in the long run, to damages not covered by the warranty.

During cleaning a slight discoloration of the leather cloth by the rubber seals should be expected for production-related reasons.

Prevent damage to the acrylic glass and plastic surfaces.

- Remove rings, watches, bracelets etc. before starting cleaning work.

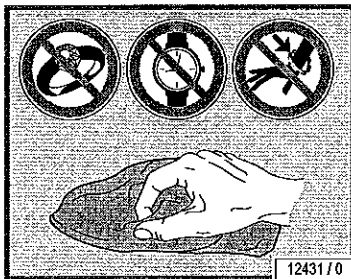

Lamps

- Low pressure lamps can be cleaned with a damp cloth (without additional cleaning agents) where necessary.

Operating panel

Do not spray!

Only rub with a damp, soft cloth.

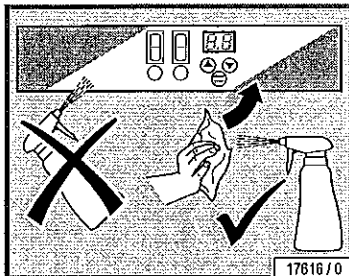

12.15.2 Cleaning/disinfection plan

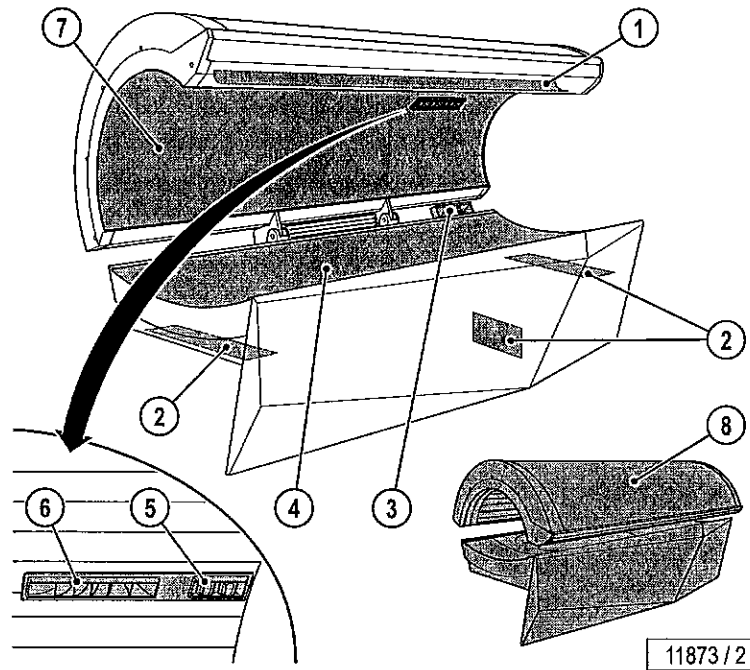

Component	Interval		Activity	See page
	After each tanning session	When necessary		
1 Handle	X		Cleaning and disinfection	47
3 Operating panel	X		Cleaning and disinfection	47
4 Acrylic panel	X		Cleaning and disinfection	48
5 Adjustable air nozzles	X		Cleaning and disinfection	47
Protective goggles	X		Cleaning and disinfection	47
6 Air nozzles		X	Clean	47
7-8 Surfaces		X	Clean	48
2 Filter			Remove and clean filter	64



NOTE:

If desired, you may set the unit to require that cleaning/disinfection be confirmed after each tanning session by pressing the START/STOP button (when the cool-down time for the main fan has finished).

12.16 How to maintain

12.16.1 Technical modifications

The device has been constructed in accordance with current safety regulations. The illustrations and specifications on these instructions are subject to technical modifications which are required in order to improve the device.

Unauthorized modifications and changes to the device and its control unit are prohibited.

Use only OEM spare parts.

12.16.2 Maintenance plan



NOTE:

The service of the device may only be carried out by authorized, trained and qualified staff.

Only use OEM spare parts of the same type! The use of other parts will void the manufacturer's warranty!

Any liability is excluded in case of damage or injury proven to be the result of the use of non-genuine spare parts.

The following maintenance activities shall be performed by the studio operator.

Maintenance performed by the studio operator

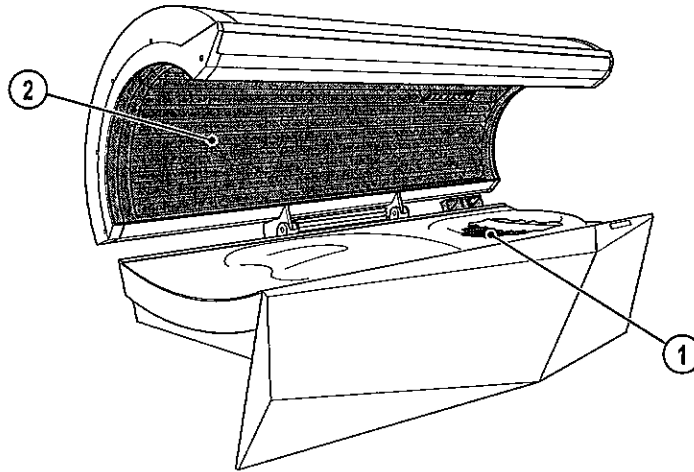

12121 / 3

Component	Interval					Activity	See page
	500 h	750 h	1000 h	1500 h	3000 h		
1 UV low pressure lamps, base	X					Replace	61
2 UV low pressure lamps, canopy	X					Replace	62
1 Starter, UV low pressure lamps, base			X			Replace	61
2 Starter, UV low pressure lamps, canopy			X			Replace	62

Maintenance performed by authorized, trained and qualified staff

In addition to the maintenance plan on page 50, the following items should be checked to ensure safe operation and use of your tanning system.

Component		Activity				
		500 h / 6 months	2000 h / 1 year	5000 h / 5 years	10000 h / 10 years	
1	Springs	X				Inspect and replace as necessary
	Springs			X		Replace
2	Bolts and fasteners of the canopy hinge mechanism		X			Inspect and replace as necessary
	Bolts and fasteners of the canopy lift mechanism		X			Inspect and replace as necessary
	Bolts and fasteners of the canopy hinge/lift mechanism				X	Replace
3	Bolts and fasteners of the base/tank hinge/lift mechanism		X			Inspect and replace as necessary
	Bolts and fasteners of the base/tank hinge/lift mechanism				X	Replace
4	Cylinders	X				Inspect and replace as necessary
	Cylinders				X	Replace
5	Chassis and associated fasteners	X				Inspect and replace as necessary
	Chassis and associated fasteners				X	Replace
6	Wiring and associated plugs / terminal connections	X				Inspect and replace as necessary
7	Acrylic panels ²	X				Inspect and replace as necessary
	Acrylic panels ²		X			Replace
11	Electrolytic capacitors				X	Replace
12	Conductors				X	Replace

¹Interval must be repeated after each inspection or replacement (i.e. 1st: 3 months, 2nd: 6 months, 3rd: 9 months, etc.)

²The schedule for acrylic replacement listed refers only to the condition of the acrylic relating to safety and does not address the efficacy of UV transmission.



NOTE:

If the device is in service for longer than 10 years, it must be completely overhauled by a trained service technician.

12.16.3 Cleaning and maintenance work preparation

Service-Kit

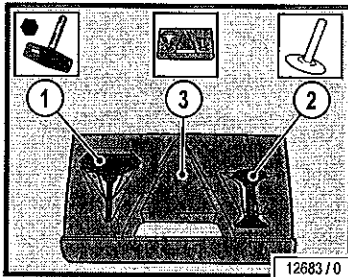

1. Allen key
2. Suction cup for filter panels, acrylic panel and canopy panel
3. Scratch prevention for the entry area (support cushion for the canopy)

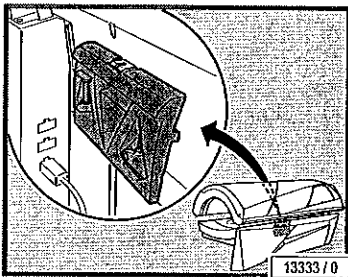

The service kit is fitted to the rear wall of the device.

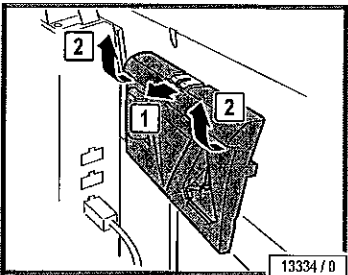

Remove service kit from support.

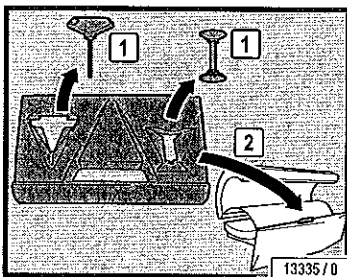

Remove Allen key and suction cup.

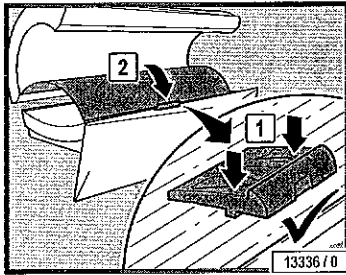

Use the cushion as scratch prevention when opening the canopy panel.

Removing the acrylic panel

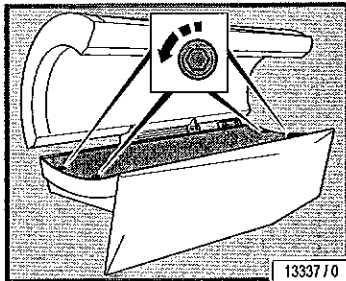

- Remove the screws and remove the washers.

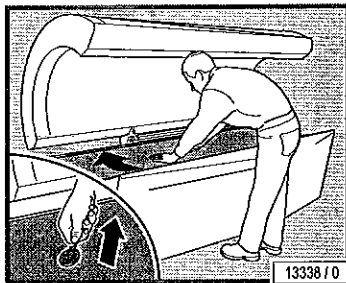

- Push the bed to the rear with one hand and pull it out of the front guide with the suction cup.

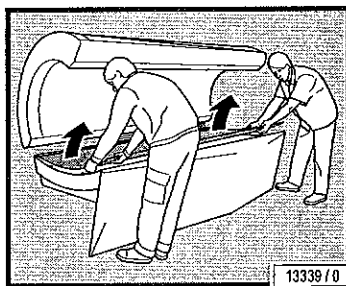

- Remove the acrylic panel and carefully lay it aside.

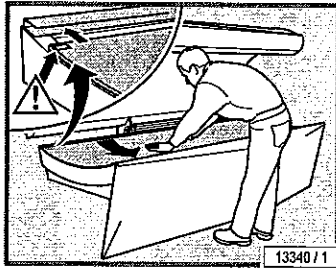

The assembly is the same process in reverse order.

⚠ WARNING!



WARNING!

Crushing hazard due to improper maintenance!

If the acrylic panel is mounted backwards, there will be a gap between front panel and acrylic panel.

- Always replace the acrylic panel as shown: The imprint on the panel must be next to the foot end at the rear side of the device.

When assembling the device please note:

- Carefully lay the acrylic panel in the guide.
- Remove fingerprints and other soiling carefully.

Removing the canopy panel

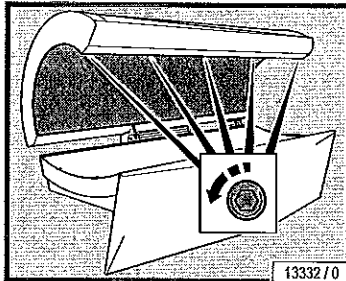

- Remove the screws. First remove the outside screws and then remove the screws in the middle.

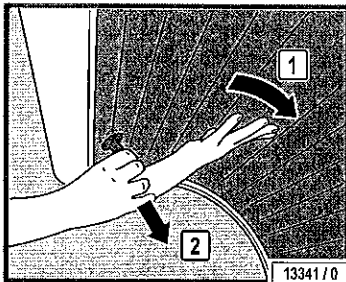

- Push the canopy panel to the rear with one hand and pull it out of the front guide with the suction cup.

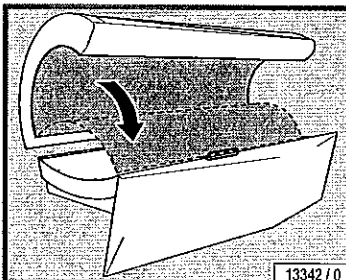

- Carefully lay the panel aside on a scratch protection.

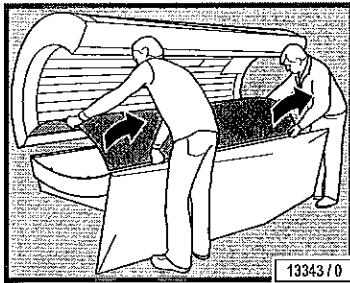

- Remove the canopy panel with the aid of a helper.

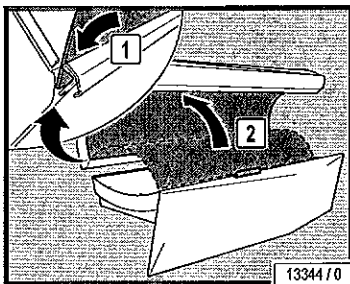

The assembly is the same process in reverse order.

When assembling the device please note:

- Use the scratch protection.
- Carefully lay the canopy panel in the guide.
- Remove fingerprints and other soiling carefully.

Remove the side section panel

Not applicable for this device.

Removing the front panel

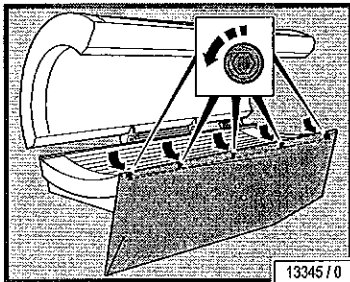

- Remove the acrylic panel: see page 54.
- If necessary, remove the screws from the inside.

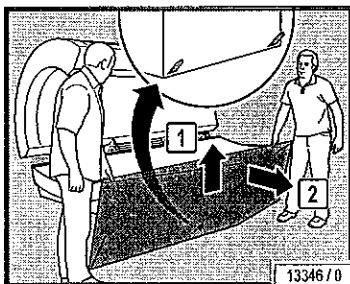

- Carefully lift the upper edge of the front panel out of the holder (pull upwards).
- Lift the front panel in order to lift it out of the two lower hooks.
- Then remove the front panel to the front and lay it aside.

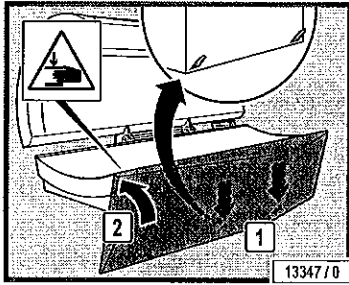

The assembly is the same process in reverse order.

! WARNING



Crushing hazard when inserting the front panel!

Fingers can be jammed when pressing in the front panel.

- Do not hold fingers between the front panel and the device when pressing.

12.16.4 Instructions for replacing the lamps



WARNING!

! WARNING!

Danger of burns from hot lamps and device parts!

If the tanning device was operated before being switched off and opened, lamps and housing parts may be hot.

- **Before replacing lamps or other spare parts, wait until lamps and metal parts of the device have cooled down sufficiently.**

The UV effect of the lamps and thus the tanning effect decreases over the course of time. Therefore, the replacement intervals specified in the maintenance plan must be adhered to.



NOTE:

Small quantities of mercury can escape if the bulb/lamp glass breaks!

Please comply with the following instructions:

- Immediately disconnect the device from the mains power.
- Children must leave the room immediately.
- Ventilate the room for at least 15 minutes.
- Put on disposable gloves.
- With the window open: Collect the glass shards and escaped mercury in a sealable container.
- Take the container to a collection site for waste lamps.

Changing the chip card

Not applicable for this device.

Low pressure lamps

WARNING



WARNING!

Danger of burns from hot lamps and device parts!

If the tanning device was operated before being switched off and opened, lamps and housing parts may be hot.

- Before replacing lamps or other spare parts, wait until lamps and metal parts of the device have cooled down sufficiently.

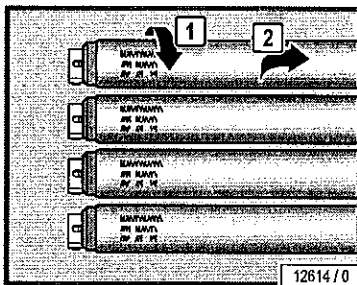

12614 / 0

- Replace faulty UV low pressure lamps immediately.
- Always replace the entire set of lamps after the specified operating time.
- Turn 90° and carefully remove from the socket.

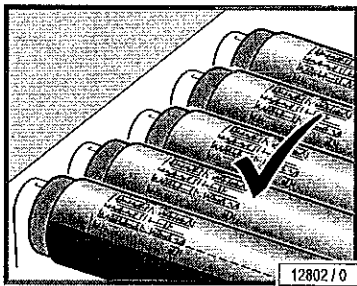

12802 / 0

- UV low pressure lamps possess a reflector which directs the light outwards. The lamps must be mounted in such a way that the rear side of the reflector is located on the device side.

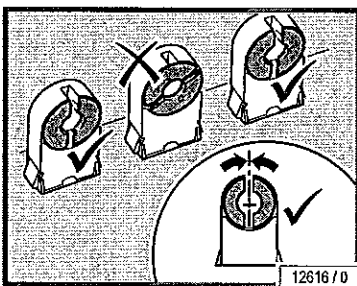

12616 / 0

- Push the pins vertically into the socket from above.

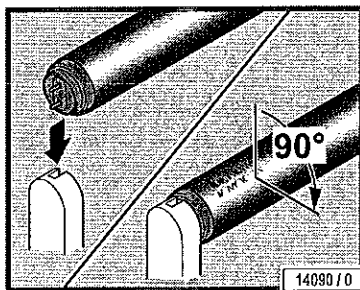

- Turn the lamp 90°.
The lettering must be oriented towards the outside (i.e. towards the tanning room or towards the user).

Makrolon tubes

Not applicable for this device.

Starter

- Replace faulty starters immediately.

You can recognize a faulty starter by the blackened ends of the lamps or when the lamps can no longer be started.

Operating a lamp with a faulty starter significantly shortens its service life. The lamp loses power and may begin to flicker under certain circumstances.

The starters are located in either one of the two lamp sockets or are visible when the lamps are removed.

- Turn 90° and carefully remove from the socket.

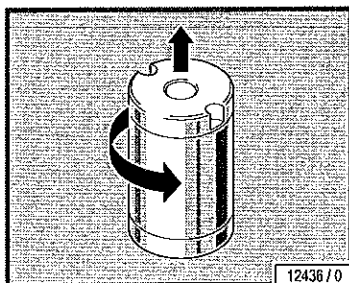

High pressure lamps and filter panels

Not applicable for this device.

12.16.5 Cleaning and disinfection of the sensor

Not applicable for this device.

12.16.6 Cleaning or replacing UV lamps in the base

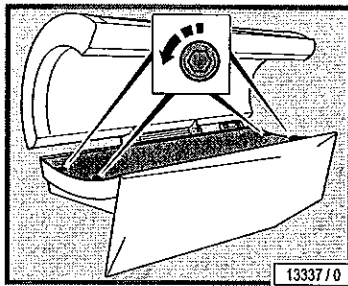

- Remove the acrylic panel: see page 53.

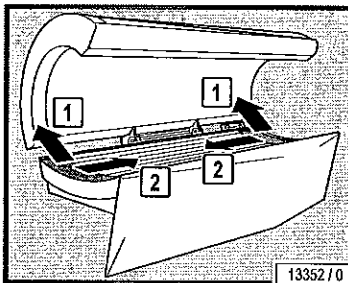

- Remove the lamp coverings at the head and foot ends.

Replace the lamps: see page 58.

Replace the starter: see page 60.

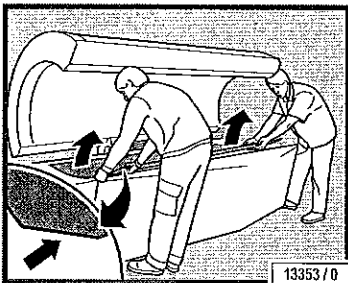

- Remove the partition and carefully set aside (only for devices with an air conditioning unit).

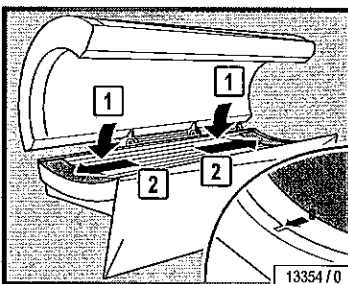

The assembly is the same process in reverse order.

When assembling the device please note:

- When positioning the lamp covering push the pins into the opening.

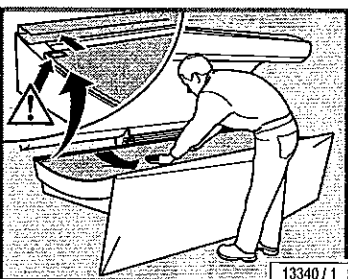

- Carefully lay the acrylic panel in the guide.

WARNING!



WARNING!

Crushing hazard due to improper maintenance!

If the acrylic panel is mounted backwards, there will be a gap between front panel and acrylic panel.

- Always replace the acrylic panel as shown: The imprint on the panel must be next to the foot end at the rear side of the device.

12.16.7 Cleaning or replacing the UV lamps in the side section

Not applicable for this device.

12.16.8 Cleaning or replacing UV lamps and filter panels in the canopy

- Remove the canopy panel: see page 55.

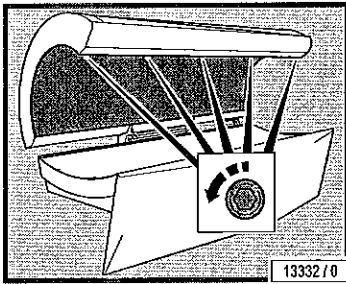

- Remove the 2 lamp covers.

Replacing lamps:
UV low pressure lamps: see page 59.
Replace the starter: see page 60.

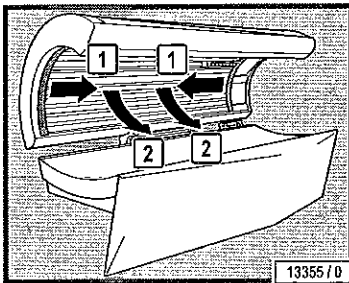

The assembly is the same process in reverse order.

When assembling the device please note:

- When replacing the lamp covers ensure that the clips are in contact with the magnets.

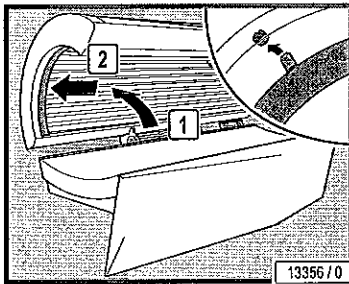

- Use scratch protection.
- Carefully lay the canopy panel in the guide.

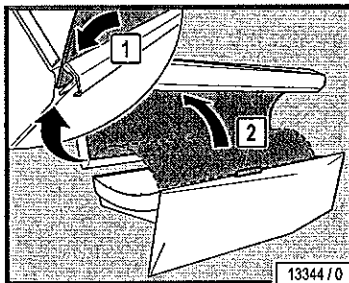

**12.16.9 Cleaning or replacing the UV lamps
and filter panels in the shoulder tanner**

Not applicable for this device.

12.16.10 Cleaning or replacing the interior lights

Not applicable for this device.

**12.16.11 Cleaning
or replacing the canopy accent lighting**

Not applicable for this device.

**12.16.12 Cleaning or replacing
the front panel accent lighting**

Not applicable for this device.

12.16.13 Cleaning the filters in the base

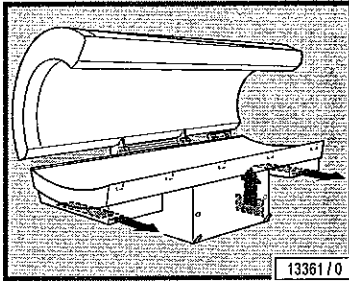

- Remove the front panel: see page 56.
- Pull out the two outside filters to the front. Remove the middle filter upwards.

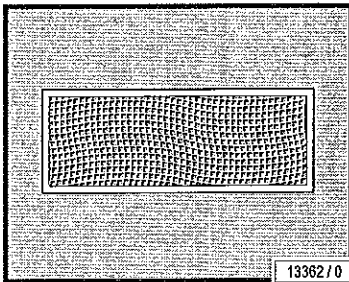

- Clean the filter moist or dry:

Dry cleaning: Vacuum cleaner (depending on the degree of soiling)
Moist cleaning: Water and detergent, or with a dishwasher.

The device may be damaged by moisture!

The cleaned filters must be dry before they are replaced.

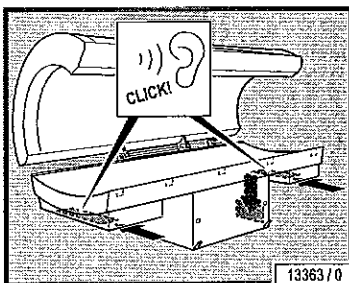

- Replace the cleaned and dried filters. The two outer filters clip into place with an audible click.

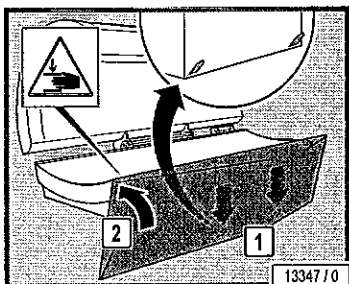

- Replace the front panel.



WARNING!
Crushing hazard when inserting the front panel!
Fingers can be jammed when pressing in the front panel.

- Do not hold fingers between the front panel and the device when pressing.

12.16.14 Cleaning the canopy filter mats

Not applicable for this device.

12.16.15 Cleaning the filter mats in shoulder tanner

Not applicable for this device.

12.16.16 Air conditioning: Empty the condensation tank and clean the filter

Not applicable for this device.

12.16.17 AQUA / AROMA SYSTEM maintenance

Not applicable for this device.

12.17 How to store the device

12.17.1 Decommissioning

The device must be disconnected from the power supply in order to temporarily or permanently decommission it.

You must abide by the legal disposal requirements when permanently decommissioning the device.

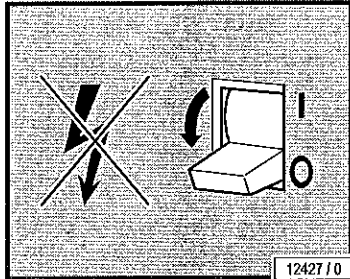

12.17.2 Storage

Store the devices in a dry, frost-free location with a stable temperature. Once the device has cooled off, pack it in plastic wrapping to protect it against scratches.

- Storage temperature: Between 5 °F (-15 °C) and 140 °F (+60 °C)

12.17.3 Disposal

Environmental regulations – disposal of lamps and batteries

UV lamps contain fluorescent materials and other waste containing mercury. Batteries contain heavy metal compounds.

Dispose of UV lamps and batteries according to the national waste disposal laws and in accordance with the municipal waste regulations.

Packaging

All packaging consists of 100 % recyclable materials.

Disposal of old devices

The device has been manufactured using recyclable materials. The JK Corporate Group will provide you with information on the content or potential hazards of the materials used.

Disposal of consumable supplies

Dispose of AQUA SYSTEM and AROMA containers and their contents according to the national waste disposal laws and in accordance with the municipal waste regulations.

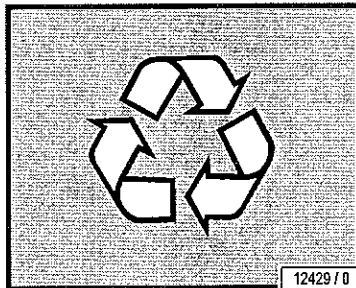

13 What to do when things go wrong

WARNING!



Follow instructions!

Failure to use protective eyewear may result in severe burns or other eye injury. If discomfort develops, discontinue use and consult a physician.

- UV devices must not be used without taking medical advice if unexpected effects, such as itching, occur within 48 hours of the first session.
- The tanning device must never be used if a filter panel is missing or damaged, or the timer is defective!
- UV light from the sun or UV systems can cause injuries to the skin or eyes. This biological effect is dependent on the sensitivity of the individual's skin and on the type and amount of UV light.
- As with natural sunlight, overexposure can cause eye and skin injury, sunburn, and allergic reactions.
- Medications (taken internally or otherwise) or cosmetics applied to the skin, may increase sensitivity to ultraviolet light.
- A person having a history of skin problems should consult a physician before use.

- **Seek medical advice if in doubt!**



NOTE:

Occasionally, persons using the tanning device will experience a slight reddening of the skin – usually in small patches – after the second or third session. This redness is often accompanied by an itching sensation. This may be nothing more than a very limited heat 'rash' caused by heat from the lamps within the device. It should go away within approximately 24 hours and should not reappear. This rashing can be lessened or prevented by applying moisturizer lotion to the affected area after the tanning session is completed.

- Follow instructions.
- The time between the first two tanning sessions must be at least 24 hours.
- Increasing tanning also requires an extension of the exposure time (= radiation time) or after a certain degree of tanning has been achieved, a further intensification is not possible. However, the radiation time may not be extended as desired within the scope of the permissible radiation doses! Therefore, only a certain degree of final tanning dependent on the skin type can be achieved without endangering your health.
- Inform users about proper tanning.

13.1 Troubleshooting

Software and device malfunctions are indicated by error codes, e.g. E005.

These error codes are output to the display to simplify troubleshooting:

- If a fault occurs, the error code flashes on the display.
- If several errors occur, the error messages are displayed alternately.
- Error elimination is acknowledged by pressing the **START/STOP** button.
- If the error cannot be cleared, contact Customer Service (see page 2) or your local service provider

More detailed information regarding the error description and solutions is available in the document 'Error Codes' #1011831-..., which you find in the Technical Documentation folder.

For authorized, trained and qualified staff:

For further technical description, please contact Customer Service (see page 2).



WARNING!

Danger of skin injuries and skin diseases.

- The tanning device must never be used if a filter panel is missing or damaged, or the timer is defective!

14 Where you can find out more

If you have any questions, please contact Customer Service (see page 2).

15 How we studied this device

The system is built to the state of the art and the applicable safety regulations.

We reserve the right to make technical changes which are necessary to improve the system or a system component even if they deviate from pictures and information in these instructions.

16 Appendix

16.1 Model-No.: JK 103 / 32-0: EMC information

16.1.1 Table 201: Guidelines and manufacturer's declaration – Electromagnetic emissions

The tanning system has been designed for use in the electromagnetic environment specified below. The device operator must ensure that it is used in such an environment.

Emission measurements	Conformity	Electromagnetic environment – Guidelines
HF emissions as per CISPR 11	Group 1	Model-No.: JK 103 / 32-0 uses HF power solely for internal functions. Therefore the HF emissions are very low and it is highly unlikely that it will cause any interference to adjacent electronic equipment.
HF emissions as per CISPR 11	Class B	Model-No.: JK 103 / 32-0 has been designed for use in all devices, including those in residential areas, and it has been determined that it can be used for residential purposes as soon as it is connected up to a public mains supply that also supplies buildings.
Harmonics IEC 61000-3-2	Class A	
Voltage fluctuations / Flicker IEC 61000-3-11	Fulfilled	The obligations listed in Sub-section 6.2.2 of EN 61000-3-11:2000 must be taken into consideration. In particular, the 0.14 ohm line impedance must be guaranteed for pulse massaging.

16.1.2 Table 202: Guidelines and manufacturer's declaration – Electromagnetic interference

The tanning system has been designed for use in the electromagnetic environment specified below. The device operator must ensure that it is used in such an environment.

Interference immunity tests	IEC 60601 - Test level	Defined level	Electromagnetic environment – Guidelines
Discharging static electricity (ESD) IEC 61000-4-2	±6 kV contact discharge ±8 kV air discharge	±6 kV contact discharge ±8 kV air discharge	–
Fast transient electrical noise / bursts IEC 61000-4-4	±2 kV for mains supplies	±2 kV for mains supplies	–
Surges 61000-4-5	±1 kV series mode voltage ±2 kV common mode voltage	±1 kV series mode voltage ±2 kV common mode voltage	–
Magnetic field radiated by supply frequency (50/60 Hz) IEC 61000-4-8	3 A/m	3 A/m	–
Voltage drops, Short interruptions and supply voltage fluctuations IEC 61000-4-11	<5% U_T (>95% drop in U_T) for 0.5 periods 40% U_T (60% drop in U_T) for 5 periods 70% U_T (30% drop in U_T) for 25 periods <5% U_T (>95% drop in U_T) for 5 s	<5% U_T (>95% drop in U_T) for 0.5 periods 40% U_T (60% drop in U_T) for 5 periods 70% U_T (30% drop in U_T) for 25 periods <5% U_T (>95% drop in U_T) for 5 s	–

Note: U_T is the mains alternating voltage used for the test levels.

16.1.3 Table 204: Guidelines and manufacturer's declaration – Electromagnetic interference

The tanning system has been designed for use in the electromagnetic environment specified below. The device operator must ensure that it is used in such an environment.

Interference immunity tests	IEC 60601 - Test level	Defined level	Electromagnetic environment – Guidelines
Conducted HF noise IEC 61000-4-6	3 Vrms 150 kHz to 80 MHz	3 Vrms	<p>Portable and mobile radios are not to be used at shorter distances to the Model-No.: JK 103 / 32-0 and its cables other than the recommended safe distance, which has been calculated according to the transmitting frequency are made.</p> <p>Recommended safe distance:</p> $d = 1.2\sqrt{P}$ $d = 1.2\sqrt{P} \text{ 80 MHz to 800 MHz}$ $d = 2.3\sqrt{P} \text{ 800 MHz to 2.5 GHz}$ <p>P is the transmitter's maximum output power (nominal rating) in Watts (W) according to the details provided by the manufacturer of the transmitter and the recommend safe distance is given in metres (m).</p> <p>The field strength of the stationary radio transmitter is for all frequencies^b in accordance with tests that were carried out onsite^a less than the determined level.</p> <p>Interference is possible in the immediate surrounding of equipment that carry the following symbols.</p> 
Radiated HF noise IEC 61000-4-3	3 V/m 80 MHz to 2.5 GHz	3 V/m	

Comment 1: The higher value applies to 80 MHz und 800 MHz.

Comment 2: These guidelines might not apply to all situations. The propagation of electromagnetic waves is affected by absorption and reflexes caused by buildings, objects and people.

- a The field strength of a stationary transmitter e.g. standard cell phone stations (mobile / cordless phones) and public mobile radio services, amateur stations, MW and UHF radio and TV transmitters) cannot be precisely determined for theoretical reasons. It is recommended that an onsite test should be carried out in order to determine the electromagnetic environment caused by stationary HF transmitters. If the field strength of the massage device determined at the installation site exceeds the defined HF level listed above then the device must be monitored with regard to its normal operation. If any abnormal characteristics are recorded then it will be necessary to introduce additional measures, such as re-orientation or converting the device.
- b The field strength must be less than 3 V/m over the frequency ranges from 150 kHz to 80 MHz.

16.1.4 Table 206: Recommended safe distances between portable and mobile HF communications equipment and Model-No.: JK 103 / 32-0

Model-No.: JK 103 / 32-0 has been designed for use in an electromagnetic environment in which the radiated HF interference is controlled. The operator of the device can help to reduce electromagnetic interference by maintaining a safe distance between the portable and mobile HF communication devices (transmitters) and the device itself as recommended below with regard to the communication device's maximum output power.

Nominal transmitter power (W)	Safe distance with regard to the transmitting frequency (m)		
	150 kHz to 80 MHz $d = 1.2\sqrt{P}$	80 MHz to 800 MHz $d = 1.2\sqrt{P}$	800 MHz to 2.5 GHz $d = 2.3\sqrt{P}$
0,01	0,12	0,12	0,23
10	3,8	3,8	7,3
1	1,2	1,2	2,3
0,1	0,38	0,38	0,73
100	12	12	23

The recommended safe distance (d) in metres (m) can be determined by using the equation that applies to the transmitters frequency in the case of transmitters where their nominal power is not listed above, whereby 'P' is the nominal transmitter power in Watts (W) according to the details supplied by the manufacturer of the transmitter.

Comment 1: The higher value applies to 80 MHz und 800 MHz.

Comment 2: The propagation of electromagnetic waves is affected by absorption and reflexes caused by buildings, objects and people.

17 JK-Products, Inc. – Limited Warranty

JK-Products, Inc. warrants its products to be free from defects in materials and workmanship under intended normal use as described in the unit's Operation and Instruction Manual, for a period of one (1) year from date of sale.

This Limited Warranty applies only to the original purchaser of the equipment through JK-Products, Inc. or its authorized dealer or distributor, and is not transferable.

Global Service USA obligations under this warranty are limited to repair or replacement of any defective part without charge for that part to the original purchaser, with the following exceptions:

A Fluorescent lamps are warranted against defects for a period of thirty (30) days from date of sale.

B Only parts obtained through JK-Products, Inc., its authorized dealers or distributors may be used. Transportation costs for parts shipped to the consumer and the return of defective parts to Global Service USA are not included.

C Labor will be furnished without charge for ninety (90) days from date of purchase only. All labor and related charges must be authorized by Global Service USA prior to start of repairs, and must coincide with Global Service USA established rates and time allotment policy.

D Acrylic: Refer to Manufacturer's Acrylic Warranty Policy. It is imperative that the original customer completes and returns the enclosed warranty card within 10 days after purchase to insure valid registration and coverage for potential claims.

If the warranty card is not registered, proof of purchase from JK-Products, Inc. or its authorized dealer or distributor will be required prior to any consideration on warranty claims. This could result in service delays.

This warranty is extended to the individual or legal entity, whose name appears on the warranty registration card filed with Global Service USA, or whose name appears on the original sale document and may not be transferred to any other individual or legal entity.

This warranty does not apply to any failure of the product, or any parts of the product due to alterations, modifications, misuse, abuse, accident, improper maintenance, improper installation, acts of God or if the serial number on the product has been removed, altered or defaced. Adequate packaging must be used for returned goods to prevent freight damage.

There are no warranties which extend beyond the description on the face hereof. There is no express or implied warranty of fitness of merchantability.

The remedies provided in this limited warranty are the exclusive remedies provided to the purchaser by Global Service USA and are provided in substitution of all other remedies. Consequential and incidental damages are excluded.

No person, firm or corporation is authorized to obligate JK-Products, Inc. for any liability in connection with the sale or use of these goods.

JK Products & Services, Inc. makes no guarantees on income, return on investment, market conditions, performance, etc. with any undertaking using its products and services. Past performance is not indicative of future results.

17.1 Limited Acrylic Warranty

JK Products, Inc. warrants its acrylic sheets to be free from defects in material and workmanship, under intended normal use, for a period of one (1) year from date of sale of the tanning bed. Due to the tanning lotions, cosmetics, disinfectant and improper cleaners used on tanning surfaces that cannot be controlled by JK Products, Inc., after the first thirty (30) days of warranty period acrylic will be subject to a prorated cost to the consumer.

JK Products, Inc. obligations do not include transportation charges on replacement acrylic.

JK Products, Inc. assumes no liability for the cost of removing defective sheets or installing replacement sheets, or for damage to persons or property.

To make a claim, contact an authorized dealer or distributor of JK-Products, Inc. or Global Service USA with the model number, the serial number, and the date of purchase of the bed in which the acrylic will be used.

There are no warranties which extend beyond the description on the face hereof. There is no express or implied warranty of fitness or merchantability.

The remedies provided in this limited warranty are the exclusive remedies provided to the purchaser by Global Service USA and are provided in substitution of all other remedies. Consequential and incidental damages are excluded.

JK Products & Services, Inc.
#1 Walter Kratz Drive
Jonesboro, AR 72401
Phone: 800-445-0624 (toll-free)
Fax: 870-935-9046
e-mail: support@jkamerica.com
<http://support.jkamerica.com>

17.2 Warranty Claims

17.2.1 Policy & Procedures

1. When to file a Warranty Claim:

In the event that your tanning system is not functioning properly under intended normal use as described in the unit's Operation and Instruction Manual, you may then have established cause to file a Warranty Claim.



NOTE:

Both the tanning system and legal registered owner must meet the criteria established under JK Products, Inc. Limited Warranty as described in this manual before any Warranty Claim will be considered.

2. Where to call to place a Warranty Claim:

JK-Products, Inc. is supported nationwide by an extensive dealer/distributor network through whom the majority of our units are sold. These dealers/distributors are required by contract to stock sufficient parts to meet the various warranty and nonwarranty needs of their customers.

Therefore, in order for you to properly file a Warranty Claim, you must locate the name and phone number of the dealer/distributor through whom you purchased your unit. Normally this information can be easily located either on your paid invoice or other proof of purchase documentation that you received when taking delivery of the unit.

Next, notify the dealer/distributor of the serial number, model number and date unit was purchased. This will initiate the Warranty Claim process.

Upon determination of the problem, your dealer/distributor can then supply you with the part(s) and proper instructions to return your unit to working order.

Each dealer/distributor has their own internal procedure for handling Warranty Claims and credits.



NOTE:

JK-Products, Inc., the manufacturer, does not involve itself in the direct handling of a Warranty Claim except where mitigating circumstances apply and where required by law.



NOTE:

If a part returned to Global Service USA proves to be operational and not defective, or if product code numbers on part do not correspond with individual unit date on file with Global Service USA, then a 30% restocking fee will be charged in addition to the retail purchase price of part.

Acknowledgment of the Agreement is not required for acceptance of the foregoing stipulations.

3. You must comply to the instructions and warnings under chapter
 - 4.1 (Intended use),
 - 5.1 (Prohibited usage) and
 6. (What you must do to avoid serious harm)

Any other use shall be considered improper. The manufacturer cannot be held liable for damage or injuries resulting from misuse. The operator bears the sole risk for this.

The proper use also includes compliance with the manufacturer's instructions, operating and maintenance conditions. This device may only be operated, maintained and repaired by persons familiar with these tasks and who are aware of the dangers involved.

17.2.2 Labor Warranty Claim/Credit Procedures

Global Service USA furnishes labor without charge for a period of 90 days from date of purchase. All labor and related charges must be authorized by Global Service USA prior to start of repairs, and must coincide with Global Service USA established rates and time allotment policy.

Please contact our Service Department for authorization and billing procedures.

17.3 Limited Lifetime Warranty

Global Service USA warrants specific individual components of the tanning system against defects in materials and workmanship for the life of the product. Coverage is limited to units purchased after November 1, 1994.

This warranty is restricted to the following components only:

- Steel Back Panels
- Structural Steel Frame Components
- Exterior Steel Body.



NOTE:

Components are warranted on an individual basis and not as they may effect the complete product.

Warranty coverage does not include cosmetic abnormalities such as scratches, nicks, dents, rust, oxidation of paint or other cosmetic changes that do not interfere with the designed function of the unit.

This warranty does not include failure of the product due to alteration, modifications, misuse, abuse, improper maintenance, improper installation or repair.

This warranty is not transferable and is only applicable to the original purchaser named on a completed and registered warranty record at JK-Products, Inc. headquarters.

JK Products, Inc. obligations do not include transportation charged on the shipping of new components to the customer or on the return of defective components of the manufacturer. All freight charges must be paid by the customer.

There are no warranties which extend beyond the description on the face hereof. There is no express or implied warranty of fitness or merchantability.

The remedies provided in this limited warranty are the exclusive remedies provided to the purchaser by Global Service USA and are provided in substitution of all other remedies. Consequential and incidental damages are excluded.



NOTE:

Any misuse, abuse, modification, alteration, improper maintenance, improper installation, etc. of this product or its intended use will subject said party to direct responsibility and liabilities for any and all consequences resulting from such action. Furthermore, such actions will void all warranties and may relieve Global Service USA of any liabilities relating to said product.

Warranty Registration

Please complete the back of the card below and return to JK Products and Services.

Ergoline

ANGEL BEAUTY

soltron

DASH **ets**SM



IMPORTANT! Your warranty card must be completed within ten (10) business days from the date of receipt for your equipment to be covered by the manufacturer's warranty.

✂ Detach Here ✂

007139201

BUSINESS REPLY MAIL
FIRST-CLASS MAIL PERMIT NO. 236 JONESBORO AR

POSTAGE WILL BE PAID BY ADDRESSEE

JK PRODUCTS & SERVICES
1 WALTER KRATZ DR
JONESBORO AR 72401-9977



NO POSTAGE
NECESSARY
IF MAILED
IN THE
UNITED STATES

Limited Warranty

JK Products and Services warrants its products to be free from defects in materials and workmanship under intended normal use as described in the Operation/Instruction Manual. Refer to the Operation/Instruction Manual for specific details.

This Limited Warranty applies only to the original purchaser of the equipment through JK Products and Services or its authorized distributors or dealers and may not be transferred.

- JK Products & Services' obligations under this warranty are limited to the repair (or replacement) of the defective part without charge to the original purchaser with the following exceptions:
- i. Lamps (fluorescent or high pressure) are warranted against defects for a period of thirty (30) days from the date of sale.
 - ii. Only parts obtained through JK Products & Services, its authorized distributors or dealers may be used.
 - iii. Replacement parts provided may be either new or reconditioned at the discretion of JK Products & Services.
 - iv. Transportation cost for parts shipped to the customer and the return of defective parts are not included.
 - v. Returned parts must be received in a condition such that its functional status at the time of its removal may be ascertained. Adequate packing must be used when returning any part to JK Products & Services. Warranty coverage may be denied for any claim where the part is damaged as a result of poor or inadequate packaging.
 - vi. Labor will be furnished without charge for a period of ninety (90) days from the date of sale to the original purchaser at the original location of installation. All labor related charges must be authorized by JK Products & Services prior to repair and performed by a technician authorized by JK Products & Services. Rates and charges for repairs must comply with JK Products & Services' alignment policy.
 - vii. Lifetime warranty applies only to main frame super-structure. Refer to the Operation/Instruction manual for specific details.

The original purchaser must complete and return the attached warranty card within ten (10) business days of receipt of equipment for coverage of potential claims under this warranty.

If no warranty card is received, proof of purchase from JK Products & Services, or an authorized distributor or dealer must be provided for a claim to be considered. JK Products & Services reserves the right to deny claims where proof of purchase has been provided but no warranty card was received.

This warranty does not apply to any failure of the product or any parts of the product due to alterations, use of third party or non-OEM parts, modifications, misuse, abuse, accident, improper maintenance, improper installation, or acts of God. This warranty also does not apply if:

- i. The serial number on the product has been removed, altered, or defaced.
- ii. The serialized components of the unit do not match with other serialized components in records maintained by JK Products & Services.
- iii. The serial number or serialized components have been altered with the intent to defraud.

There are no warranties which extend beyond the description on the face hereof. There is no express or implied warranty of fitness or merchantability. The remedies provided in this Limited Warranty are the exclusive remedies provided to the original purchaser by JK Products & Services and are provided in substitution of all other remedies. Consequential and incidental damages are excluded.

No person, firm, or corporation is authorized to obligate JK Products & Services for any liability in connection with the sale or use of these goods.

JK Products & Services • One Walker Road, Suite 4 • Johnson, AR 72401
 P.O. Box 1130 • 501.643.0050

◀ Detach Here ▶

Studio/Salon Name: _____
 Contact Name: _____
 Street Address: _____
 City: _____ State: _____ Zip: _____
 Telephone: _____ Start-Up Date: _____
 JK Distributor/Affiliate: _____

Indicate below that each of the task below have been completed/that the aspects of the tanning system are in working order:

Lamps:	Features/Options:	Training:
<input type="checkbox"/> Body	<input type="checkbox"/> Skin Sensor	<input type="checkbox"/> Basic Operation
<input type="checkbox"/> Base	<input type="checkbox"/> Air Conditioning	<input type="checkbox"/> Accessory Lamps
<input type="checkbox"/> Canopy	<input type="checkbox"/> Aqua Mist	<input type="checkbox"/> Location/Access
<input type="checkbox"/> Facial Lamps	<input type="checkbox"/> Aroma	<input type="checkbox"/> Filters
<input type="checkbox"/> Shoulder Tanner	<input type="checkbox"/> Audio System	<input type="checkbox"/> Explanation of Features
<input type="checkbox"/> Decor	Missing Components:	Settings/Adjustments:
	<input type="checkbox"/> Macunits	<input type="checkbox"/> Audio
	<input type="checkbox"/> Hardware	<input type="checkbox"/> Springs
	<input type="checkbox"/> Accessories	<input type="checkbox"/> Network

By signing below, you confirm that the listed equipment was delivered to the stated address, installed, and was received in full and satisfactory working order.

 Signature, JK Dist./Affiliate Date

 Signature, Studio/Salon Representative Date

TANNING SYSTEM Affix Serialized Label Here	ACCESSORY 1 Affix Serialized Label Here
ACCESSORY 2 Affix Serialized Label Here	

Please indicate (by marking an X) on the applicable illustration any damage to the tanning system

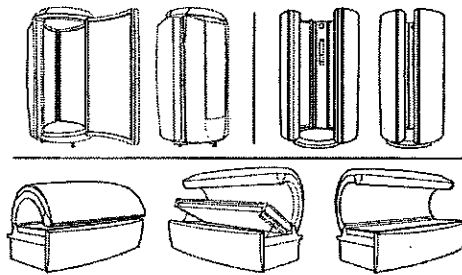

Comments: _____

18 Index

A		I	
Acrylic panel		Installation location	14
load	24	Intended use	28
Air routing	14	L	
Application tips	43	Lamp configuration	26
C		Lamps, replacing	58
Care	44	Low pressure lamps	59
Chip card replacement	58	M	
Cleaning	44, 47	Maintenance overview	46, 50
filter	64	N	
Commissioning	16	Noise level	24
Customer Service	2	O	
D		Obligations	
Decommissioning	66	of the studio operator	33
Definitions	6	Operating altitude	15
Device description	12	Order numbers	26, 27
Dimensions	25	P	
Disinfection	47	Packaging	66
Disposal	66	Plastic surfaces (care)	48
E		Power rating	24
Electrical specifications	24	Prohibited usage	29
EMC information	71	R	
Export	11	Recycling	66
F		Removing the acrylic panel	54
Facial tanner		Removing the canopy panel	55
cleaning/replacing	62	Removing the front panel	56
maintenance intervals ...	46, 50		
Filter			
cleaning	64		
cleaning/			
disinfection intervals	49		
Filter panels	62		
maintenance intervals ...	46, 50		
Foreseeable misuse	33		
Functions	41		
G			
Guidelines	11		

S

Safety measures	
during maintenance work.....	45
Scope of delivery.....	11
Setup location	15
Skin types.....	38
Spare parts.....	46, 50
order numbers	27
Staff training	33
Starter	26, 60
Storage.....	66

T

Tanning times.....	39
Technical data.....	24
Transport.....	14
Troubleshooting	68

U

UV lamps	
base.....	61
control.....	26
facial tanner.....	62
power rating.....	26

V

Ventilation	14
-------------------	----