

ASSEMBLY & OPERATING MANUAL

# BodyScan & Klassik Series

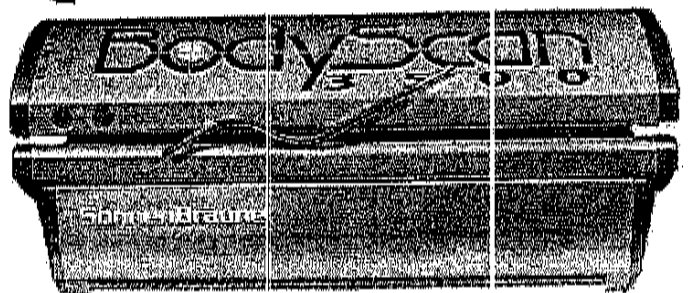
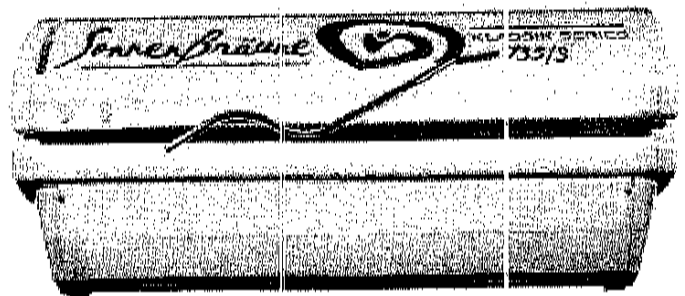
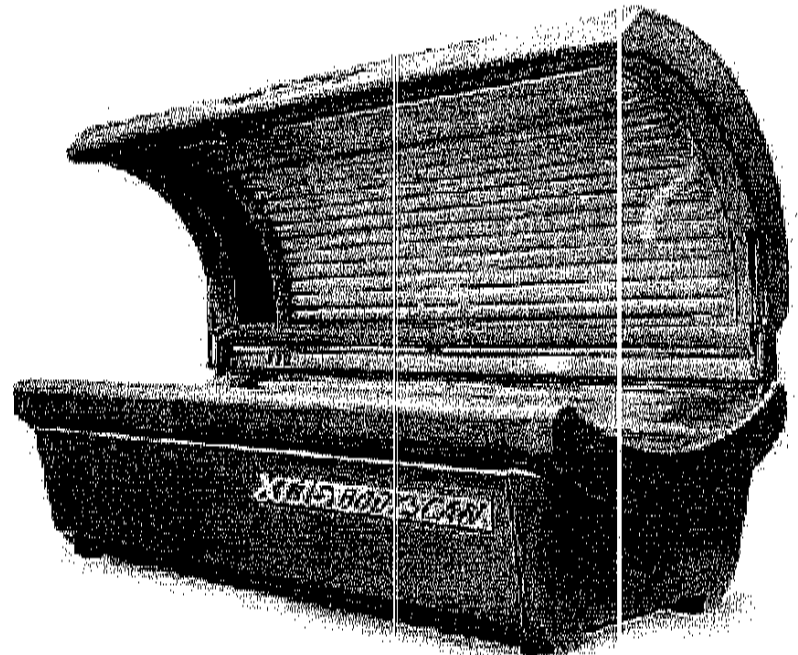
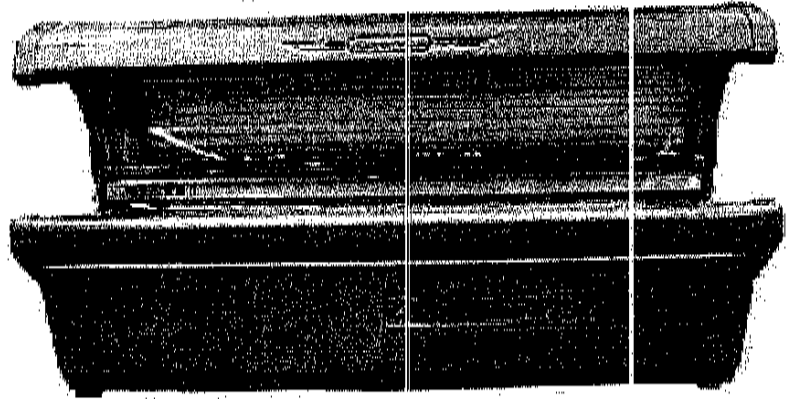

*SonnenBräune*

SonnenBräune, Inc.  
6362 Battlefield Parkway  
Ringgold, Georgia 30736 USA  
800-829-6533  
[www.sonnenbraune.com](http://www.sonnenbraune.com)  
Volume Edition 2/11 ©2004  
SonnenBräune, Inc.

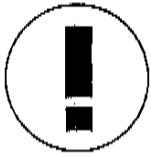

**> WARNING LABEL - PLEASE READ**

Located on tanning bed canopy -  
Please read important safety information  
relating to the proper operation of this  
equipment.

**DANGER:** ULTRAVIOLET RADIATION. FOLLOW INSTRUCTIONS. AVOID OVER EXPOSURE. AS WITH NATURAL SUNLIGHT, OVEREXPOSURE CAN CAUSE EYE AND SKIN INJURY AND ALLERGIC REACTION. REPEATED EXPOSURE MAY CAUSE PREMATURE AGING OF THE SKIN AND SKIN CANCER.

**WEAR PROTECTIVE EYEWEAR; FAILURE TO MAY RESULT IN SEVERE BURNS OR LONG-TERM INJURY TO THE EYES**

**CAUTION! EXPOSURE POSITIONS OTHER THAN SPECIFIED CAN BE HARMFUL AND ARE NOT RECOMMENDED**

THIS PRODUCT IS IN CONFORMITY WITH PERFORMANCE STANDARDS FOR SUNLAMP PRODUCTS UNDER NO. 21 CFR SUBCHAPTER J.

MEDICATION OR COSMETICS MAY INCREASE YOUR SENSITIVITY TO THE ULTRAVIOLET RADIATION. CONSULT PHYSICIAN BEFORE USING SUNLAMP IF YOU ARE USING MEDICATIONS OR HAVE A HISTORY OF SKIN PROBLEMS OR BELIEVE YOURSELF ESPECIALLY SENSITIVE TO SUN LIGHT. IF YOU DO NOT TAN IN THE SUN, YOU ARE UNLIKELY TO TAN FROM THE USE OF THIS PRODUCT.

SKIN TYPE	RECOMMENDED EXPOSURE SCHEDULE:				BIWEEKLY MAINTENANCE SESSIONS
	WEEK 1 SESSIONS 1-3	WEEK 2 SESSIONS 4-6	WEEK 3 SESSIONS 7-10	WEEK 4 SESSIONS 11-15	
II FAIR	3 MIN.	6 MIN.	8 MIN.	10 MIN.	12 MIN.
III MEDIUM	3 MIN.	6 MIN.	8 MIN.	10 MIN.	12 MIN.
IV DARK	3 MIN.	3 MIN.	10 MIN.	15 MIN.	15 MIN.
V VERY DARK	3 MIN.	8 MIN.	10 MIN.	15 MIN.	15 MIN.

MAXIMUM USE TIME: 10 MINUTES  
IN MOST CASES, TANNING WILL APPEAR WITHIN SIX HOURS OF THE FIRST APPLICATION. PROVIDED YOUR SKIN IS CAPABLE OF DEVELOPING A TAN. A MOISTURIZER MAY BE USED AFTER EACH TANNING SESSION.  
THIS SYSTEM IS INTENDED TO BE USED ONLY WITH THE "WOLFF" SYSTEM BODYSCAN XR PLUS T7170100W BIPN OR COSMOLUX VLR 18810100W BIPN AND PHILIPS GLED 1886005 400W

THIS DEVICE IS INTENDED TO BE USED BY ONE PERSON AT A TIME. YOU MAY LIE DIRECTLY ON TANNING SURFACE.

THE MINIMUM EXPOSURE POSITION IS 0.3 IN. (1.27CM) FROM THE LAMP'S SURFACE (PRESET BY THE MANUFACTURER). READ THE INSTRUCTION BOOKLET BEFORE USING THIS DEVICE.

SKIN TYPE II - THIS IS THE INDIVIDUAL THAT USUALLY BURNS EASILY AND SEVERELY, TANS MINIMALLY OR LIGHTLY AND PEELS.  
SKIN TYPE III - OFTEN REFERRED TO AS "AVERAGE COMPLEXION," BURNS MODERATELY AND TANS ABOUT AVERAGE.  
SKIN TYPE IV - THIS INDIVIDUAL BURNS MINIMALLY, TANS EASILY AND ABOVE AVERAGE.  
SKIN TYPE V - THIS INDIVIDUAL'S SKIN PARELY BURNS, TANS EASILY AND SUBSTANTIALLY.

FOR PARTS AND SERVICE CALL:  
SonnenBeds, Inc.  
Ringgold GA  
1-800-829-6533



WARNING LABEL - PLEASE READ

Located on tanning bed bench -  
Please read important safety information  
relating to the proper operation of this  
equipment.

THIS DEVICE IS INTENDED TO BE USED BY ONE PERSON AT A TIME. YOU MAY LIE DIRECTLY ON TANNING SURFACE.

THE MINIMUM EXPOSURE POSITION IS 0.5 M (1.75 FT) FROM THE LAMP'S SURFACE. PRESET BY THE MANUFACTURER. READ THE INSTRUCTION BOOKLET BEFORE USING THIS DEVICE.

SKIN TYPE II - THIS IS THE INDIVIDUAL THAT USUALLY BURNS EASILY AND SEVERELY. TANS MINIMALLY OR LIGHTLY AND FEELS SKIN TYPE III - PERSON REFERRED TO AS "AVERAGE" SUFFER FROM BURNS MODERATELY AND TANS ABOUT AVERAGE. SKIN TYPE IV - THIS INDIVIDUAL BURNS MINIMALLY, TANS EASILY AND ABOVE AVERAGE. SKIN TYPE V - THIS INDIVIDUAL'S SKIN BARELY BURNS, TANS EASILY AND SUBSTANTIALLY.

FOR PARTS AND SERVICE CALL:

Solarium, Inc.  
10000 W. 10th St.  
Tucson, AZ 85733  
1-800-829-8533

MEDICATION OR COSMETICS MAY INCREASE YOUR SENSITIVITY TO THE ULTRAVIOLET RADIATION. CONSULT PHYSICIAN BEFORE USING SUNLAMP IF YOU ARE USING MEDICATIONS OR HAVE A HISTORY OF SKIN PROBLEMS OR BELIEVE YOURSELF ESPECIALLY SENSITIVE TO SUNLIGHT. IF YOU DO NOT TAN IN THE SUN, YOU ARE UNLIKELY TO TAN FROM THE USE OF THIS PRODUCT.

SKIN TYPE	WEEK 1 SESSIONS 1-3	WEEK 2 SESSIONS 4-5	WEEK 3 SESSIONS 7-10	WEEK 4 SESSIONS 11-15	BI-WEEKLY MAINTENANCE SESSIONS
II (FAIR)	4 MIN	8 MIN	12 MIN	16 MIN	20 MIN
III (MEDIUM)	4 MIN	8 MIN	12 MIN	16 MIN	20 MIN
IV (DARK)	4 MIN	8 MIN	12 MIN	16 MIN	20 MIN

MAXIMUM USE TIME: 15 MINUTES  
IN MOST CASES, TANNING WILL APPEAR WITHIN SEVERAL HOURS OF THE FIRST APPLICATION. PROVIDED YOUR SKIN IS CAPABLE OF DEVELOPING A TAN, A MAXIMUM TANNER MAY BE USED AFTER EACH TANNING SESSION. THIS SYSTEM IS INTENDED TO BE USED ONLY WITH THE WHOLE SYSTEM BOUTIQUE X PLUS FT 1000R BIPIR OR

**DANGER:** ULTRAVIOLET RADIATION, ROLL-OVER INSTRUCTIONS, AND OVER EXPOSURE, AS WITH NATURAL SUNLIGHT, OVER EXPOSURE CAN CAUSE EYE AND SKIN IRRITATION AND ALLERGIC REACTION. REPEATED EXPOSURE MAY CAUSE PREMATURE AGING OF THE SKIN AND SKIN CANCER.  
**WEAR PROTECTIVE EYEWEAR; FAILURE TO MAY RESULT IN SEVERE BURNS OR LONG-TERM INJURY TO THE EYES**

**CAUTION! EXPOSURE POSITIONS OTHER THAN SPECIFIED CAN BE HARMFUL AND ARE NOT RECOMMENDED**

THIS PRODUCT IS IN CONFORMANCE WITH FEDERAL REGULATIONS AND STANDARDS FOR SUNLAMP PANEL DETECTS UNDER NO. 21 CFR SUBCHAPTER J.

**DANGER:** ULTRAVIOLET RADIATION, ROLL-OVER INSTRUCTIONS, AND OVER EXPOSURE, AS WITH NATURAL SUNLIGHT, OVER EXPOSURE CAN CAUSE EYE AND SKIN IRRITATION AND ALLERGIC REACTION. REPEATED EXPOSURE MAY CAUSE PREMATURE AGING OF THE SKIN AND SKIN CANCER.  
**WEAR PROTECTIVE EYEWEAR; FAILURE TO MAY RESULT IN SEVERE BURNS OR LONG-TERM INJURY TO THE EYES**

**CAUTION! EXPOSURE POSITIONS OTHER THAN SPECIFIED CAN BE HARMFUL AND ARE NOT RECOMMENDED**

THIS PRODUCT IS IN CONFORMANCE WITH FEDERAL REGULATIONS AND STANDARDS FOR SUNLAMP PANEL DETECTS UNDER NO. 21 CFR SUBCHAPTER J.

MEDICATION OR COSMETICS MAY INCREASE YOUR SENSITIVITY TO THE ULTRAVIOLET RADIATION. CONSULT PHYSICIAN BEFORE USING SUNLAMP IF YOU ARE USING MEDICATIONS OR HAVE A HISTORY OF SKIN PROBLEMS OR BELIEVE YOURSELF ESPECIALLY SENSITIVE TO SUNLIGHT. IF YOU DO NOT TAN IN THE SUN, YOU ARE UNLIKELY TO TAN FROM THE USE OF THIS PRODUCT.

SKIN TYPE	WEEK 1 SESSIONS 1-3	WEEK 2 SESSIONS 4-5	WEEK 3 SESSIONS 7-10	WEEK 4 SESSIONS 11-15	BI-WEEKLY MAINTENANCE SESSIONS
II (FAIR)	4 MIN	8 MIN	12 MIN	16 MIN	20 MIN
III (MEDIUM)	4 MIN	8 MIN	12 MIN	16 MIN	20 MIN
IV (DARK)	4 MIN	8 MIN	12 MIN	16 MIN	20 MIN

MAXIMUM USE TIME: 15 MINUTES  
IN MOST CASES, TANNING WILL APPEAR WITHIN SEVERAL HOURS OF THE FIRST APPLICATION. PROVIDED YOUR SKIN IS CAPABLE OF DEVELOPING A TAN, A MAXIMUM TANNER MAY BE USED AFTER EACH TANNING SESSION. THIS SYSTEM IS INTENDED TO BE USED ONLY WITH THE WHOLE SYSTEM BOUTIQUE X PLUS FT 1000R BIPIR OR A AND PHILIPS CLEO RPIA 09 SR. BURY

THIS DEVICE IS INTENDED TO BE USED BY ONE PERSON AT A TIME. YOU MAY LIE DIRECTLY ON TANNING SURFACE.

THE MINIMUM EXPOSURE POSITION IS 0.5 M (1.75 FT) FROM THE LAMP'S SURFACE. PRESET BY THE MANUFACTURER. READ THE INSTRUCTION BOOKLET BEFORE USING THIS DEVICE.

SKIN TYPE II - THIS IS THE INDIVIDUAL THAT USUALLY BURNS EASILY AND SEVERELY. TANS MINIMALLY OR LIGHTLY AND FEELS SKIN TYPE III - PERSON REFERRED TO AS "AVERAGE" SUFFER FROM BURNS MODERATELY AND TANS ABOUT AVERAGE. SKIN TYPE IV - THIS INDIVIDUAL BURNS MINIMALLY, TANS EASILY AND ABOVE AVERAGE. SKIN TYPE V - THIS INDIVIDUAL'S SKIN BARELY BURNS, TANS EASILY AND SUBSTANTIALLY.

FOR PARTS AND SERVICE CALL:

Solarium, Inc.  
10000 W. 10th St.  
Tucson, AZ 85733  
1-800-829-8533



WARNING LABEL - PLEASE READ

Located on tanning bed bench -  
Please read important safety information  
relating to the proper operation of this  
equipment.

THIS DEVICE IS INTENDED TO BE USED BY ONE PERSON AT A TIME. YOU MAY LIE DIRECTLY ON TANNING SURFACE.

THE MINIMUM EXPOSURE POSITION IS 0.375 (1.25 CM) FROM THE LAMP'S SURFACE (PRESET BY THE MANUFACTURER). READ THE INSTRUCTION BOOKLET BEFORE USING THIS DEVICE.

SKIN TYPE II - THIS IS THE INDIVIDUAL THAT USUALLY BURNS EASILY AND SEVERELY. TANS MINIMALLY OR LIGHTLY AND IS REFERRED TO AS "AVERAGE". SKIN TYPE III - BURNES MODERATELY AND TANS ABOUT AVERAGE.  
SKIN TYPE IV - THIS INDIVIDUAL BURNS MINIMALLY. TANS EASILY AND ADOPTS AN AVERAGE.  
SKIN TYPE V - THIS INDIVIDUAL'S SKIN RARELY BURNS. TANS EASILY AND SUBSTANTIALLY.

FOR PARTS AND SERVICE CALL:  
Solaire tanning, Inc.  
P.O. Box 100  
1-800-928-5530

MEDICATION OR COSMETICS MAY INCREASE YOUR SENSITIVITY TO THE ULTRAVIOLET RADIATION. CONSULT PHYSICIAN BEFORE USING SUNLAMP IF YOU ARE USING MEDICATIONS OR HAVE A HISTORY OF SKIN PROBLEMS. OR BELIEVE YOURSELF ESPECIALLY SENSITIVE TO SUNLIGHT. IF YOU DO NOT TAN IN THE SUN, YOU ARE UNLIKELY TO TAN FROM THE USE OF THIS PRODUCT.

RECOMMENDED EXPOSURE SCHEDULE:	WEEK 1	WEEK 2	WEEK 3	WEEK 4	BI-WEEKLY MAINTENANCE SESSIONS
SESSIONS 1-3	4 MIN.	8 MIN.	12 MIN.	16 MIN.	20 MIN.
SESSIONS 4-5	4 MIN.	8 MIN.	12 MIN.	16 MIN.	20 MIN.
SESSIONS 6-7	4 MIN.	8 MIN.	12 MIN.	16 MIN.	20 MIN.
SESSIONS 8-9	4 MIN.	8 MIN.	12 MIN.	16 MIN.	20 MIN.

MAXIMUM USE TIME: 15 MINUTES  
IN MOST CASES, TANNING WILL APPEAR WITHIN SIX HOURS OF THE FIRST APPLICATION. PROVIDED YOUR SKIN IS CAPABLE OF DEVELOPING A TAN, A REDDENED WATER USED AFTER EACH TANNING SESSION. THIS SYSTEM IS INTENDED TO BE USED ONLY WITH THIS MODEL SYSTEM BOOT/SOUL X PLUS 77 ULTRAVIOLET BURN OR

**DANGER:** ULTRAVIOLET RADIATION FOLLOW INSTRUCTIONS. AVOID OVER EXPOSURE. AS WITH NATURAL SUNLIGHT, OVER EXPOSURE CAN CAUSE EYE AND SKIN IRRITATION AND ALLERGIC REACTION. REPEATED EXPOSURE MAY CAUSE PREMATURE AGING OF THE SKIN AND SKIN CANCER.  
**WEAR PROTECTIVE EYEWEAR; FAILURE TO MAY RESULT IN SEVERE BURNS OR LONG-TERM INJURY TO THE EYES**

**CAUTION! EXPOSURE POSITIONS OTHER THAN SPECIFIED CAN BE HARMFUL AND ARE NOT RECOMMENDED**

THIS PRODUCT IS IN COMPLIANCE WITH FEDERAL SAFETY STANDARDS FOR SUNLAMP PRODUCTS UNDER NO. 21 CFR SUBCHAPTER 1.

MEDICATION OR COSMETICS MAY INCREASE YOUR SENSITIVITY TO THE ULTRAVIOLET RADIATION. CONSULT PHYSICIAN BEFORE USING SUNLAMP IF YOU ARE USING MEDICATIONS OR HAVE A HISTORY OF SKIN PROBLEMS. OR BELIEVE YOURSELF ESPECIALLY SENSITIVE TO SUNLIGHT. IF YOU DO NOT TAN IN THE SUN, YOU ARE UNLIKELY TO TAN FROM THE USE OF THIS PRODUCT.

RECOMMENDED EXPOSURE SCHEDULE:	WEEK 1	WEEK 2	WEEK 3	WEEK 4	BI-WEEKLY MAINTENANCE SESSIONS
SESSIONS 1-3	4 MIN.	8 MIN.	12 MIN.	16 MIN.	20 MIN.
SESSIONS 4-5	4 MIN.	8 MIN.	12 MIN.	16 MIN.	20 MIN.
SESSIONS 6-7	4 MIN.	8 MIN.	12 MIN.	16 MIN.	20 MIN.
SESSIONS 8-9	4 MIN.	8 MIN.	12 MIN.	16 MIN.	20 MIN.

MAXIMUM USE TIME: 15 MINUTES  
IN MOST CASES, TANNING WILL APPEAR WITHIN SIX HOURS OF THE FIRST APPLICATION. PROVIDED YOUR SKIN IS CAPABLE OF DEVELOPING A TAN, A REDDENED WATER USED AFTER EACH TANNING SESSION. THIS SYSTEM IS INTENDED TO BE USED ONLY WITH THE MODEL SYSTEM BOOT/SOUL X PLUS 77 ULTRAVIOLET BURN OR A110 PML 75 C L10 H2A30 SF 20H

**DANGER:** ULTRAVIOLET RADIATION FOLLOW INSTRUCTIONS. AVOID OVER EXPOSURE. AS WITH NATURAL SUNLIGHT, OVER EXPOSURE CAN CAUSE EYE AND SKIN IRRITATION AND ALLERGIC REACTION. REPEATED EXPOSURE MAY CAUSE PREMATURE AGING OF THE SKIN AND SKIN CANCER.  
**WEAR PROTECTIVE EYEWEAR; FAILURE TO MAY RESULT IN SEVERE BURNS OR LONG-TERM INJURY TO THE EYES**

**CAUTION! EXPOSURE POSITIONS OTHER THAN SPECIFIED CAN BE HARMFUL AND ARE NOT RECOMMENDED**

THIS PRODUCT IS IN COMPLIANCE WITH FEDERAL SAFETY STANDARDS FOR SUNLAMP PRODUCTS UNDER NO. 21 CFR SUBCHAPTER 1.

THIS DEVICE IS INTENDED TO BE USED BY ONE PERSON AT A TIME. YOU MAY LIE DIRECTLY ON TANNING SURFACE.

THE MINIMUM EXPOSURE POSITION IS 0.375 (1.25 CM) FROM THE LAMP'S SURFACE (PRESET BY THE MANUFACTURER). READ THE INSTRUCTION BOOKLET BEFORE USING THIS DEVICE.

SKIN TYPE II - THIS IS THE INDIVIDUAL THAT USUALLY BURNS EASILY AND SEVERELY. TANS MINIMALLY OR LIGHTLY AND FEELS. SKIN TYPE III - BURNES MODERATELY AND TANS ABOUT AVERAGE.  
SKIN TYPE IV - THIS INDIVIDUAL BURNS MINIMALLY. TANS EASILY AND ADOPTS AN AVERAGE.  
SKIN TYPE V - THIS INDIVIDUAL'S SKIN RARELY BURNS. TANS EASILY AND SUBSTANTIALLY.

FOR PARTS AND SERVICE CALL:  
Solaire tanning, Inc.  
P.O. Box 100  
1-800-928-5530



WARNING LABEL - PLEASE READ

Located on tanning bed bench -  
Please read important safety information  
relating to the proper operation of this  
equipment.

THIS DEVICE IS INTENDED TO BE USED BY ONE PERSON AT A TIME. YOU MAY LIE DIRECTLY ON TANNING SURFACE.

THE MINIMUM EXPOSURE POSITION IS 15 IN. (1-3708) FROM THE LAMP'S SURFACE (PRESET BY THE MANUFACTURER). READ THE INSTRUCTION BOOKLET BEFORE USING THIS DEVICE.

SKIN TYPE II - THIS IS THE INDIVIDUAL THAT USUALLY BURNS EASILY AND SEVERELY. TANS MINIMALLY OR LIGHTLY AND FEELS COMPLETELY BURNED. MODERATELY AND TANS ABOUT AVERAGE.

SKIN TYPE IV - THIS INDIVIDUAL BURNS MINIMALLY. TANS EASILY AND SEVERELY. MODERATELY AND TANS ABOUT AVERAGE AND SUBSTANTIALLY.

FOR PARTS AND SERVICE CALL:

Sonnenbrunne, Inc.  
Riverside, CA  
1-800-826-8533

THIS DEVICE IS INTENDED TO BE USED BY ONE PERSON AT A TIME. YOU MAY LIE DIRECTLY ON TANNING SURFACE.

THE MINIMUM EXPOSURE POSITION IS 15 IN. (1-3708) FROM THE LAMP'S SURFACE (PRESET BY THE MANUFACTURER). READ THE INSTRUCTION BOOKLET BEFORE USING THIS DEVICE.

SKIN TYPE II - THIS IS THE INDIVIDUAL THAT USUALLY BURNS EASILY AND SEVERELY. TANS MINIMALLY OR LIGHTLY AND FEELS COMPLETELY BURNED. MODERATELY AND TANS ABOUT AVERAGE.

SKIN TYPE IV - THIS INDIVIDUAL BURNS MINIMALLY. TANS EASILY AND SEVERELY. MODERATELY AND TANS ABOUT AVERAGE AND SUBSTANTIALLY.

FOR PARTS AND SERVICE CALL:

Sonnenbrunne, Inc.  
Riverside, CA  
1-800-826-8533

PLEASE YOUR  
RADIATION  
SUNLAMP IF  
WEA HISTORY  
YOURSELF  
IF YOU DO  
LIKELY TO TAN

WEEKLY  
REINFORCE  
SESSIONS  
4 MIN.  
5 MIN.  
5 MIN.  
5 MIN.

PLEASE YOUR  
RADIATION  
SUNLAMP IF  
WEA HISTORY  
YOURSELF  
IF YOU DO  
LIKELY TO TAN

WEEKLY  
REINFORCE  
SESSIONS  
4 MIN.  
5 MIN.  
5 MIN.  
5 MIN.

IPN CR

CAUTION: AVOID OVER EXPOSURE AS WITH  
NATURAL SUN. REPEATED  
EXPOSURE CAN CAUSE  
FAILURE TO MAY  
LONG-TERM INJURY

RECOMMENDED EXPOSURE

WEEK	SESSIONS	TIME
WEEK 1	SESSIONS 1-3	3 MIN.
WEEK 2	SESSIONS 4-5	4 MIN.
WEEK 3	SESSIONS 6-7	5 MIN.
WEEK 4	SESSIONS 8-9	5 MIN.
WEEK 5	SESSIONS 10-11	5 MIN.

USE TIME: 10 MINUTES

IF YOU TANS WILL APPEAR WITHIN SEVERAL HOURS OF THE  
LAST SESSION. IF YOU DEVELOP A TANNING SURFACE, YOU MAY  
BE AT RISK OF DEVELOPING A TANNING SURFACE. IT IS  
INTENDED TO BE USED ONLY WITH THE DEVICE.

CAUTION: AVOID OVER EXPOSURE AS WITH  
NATURAL SUN. REPEATED  
EXPOSURE CAN CAUSE  
FAILURE TO MAY  
LONG-TERM INJURY

RECOMMENDED EXPOSURE

WEEK	SESSIONS	TIME
WEEK 1	SESSIONS 1-3	3 MIN.
WEEK 2	SESSIONS 4-5	4 MIN.
WEEK 3	SESSIONS 6-7	5 MIN.
WEEK 4	SESSIONS 8-9	5 MIN.
WEEK 5	SESSIONS 10-11	5 MIN.

USE TIME: 15 MINUTES

IF YOU TANS WILL APPEAR WITHIN SIX HOURS OF THE  
LAST SESSION. IF YOU DEVELOP A TANNING SURFACE, YOU MAY  
BE AT RISK OF DEVELOPING A TANNING SURFACE. IT IS  
INTENDED TO BE USED ONLY WITH THE DEVICE.

XT10 1

DANGER  
NATURAL SUN  
REPEATED  
EXPOSURE  
CAN CAUSE  
FAILURE TO  
MAY  
LONG-TERM  
INJURY

RECOMMENDED EXPOSURE

WEEK	SESSIONS	TIME
WEEK 1	SESSIONS 1-3	3 MIN.
WEEK 2	SESSIONS 4-5	4 MIN.
WEEK 3	SESSIONS 6-7	5 MIN.
WEEK 4	SESSIONS 8-9	5 MIN.
WEEK 5	SESSIONS 10-11	5 MIN.

USE TIME: 10 MINUTES

IF YOU TANS WILL APPEAR WITHIN SEVERAL HOURS OF THE  
LAST SESSION. IF YOU DEVELOP A TANNING SURFACE, YOU MAY  
BE AT RISK OF DEVELOPING A TANNING SURFACE. IT IS  
INTENDED TO BE USED ONLY WITH THE DEVICE.

XT15

DANGER  
NATURAL SUN  
REPEATED  
EXPOSURE  
CAN CAUSE  
FAILURE TO  
MAY  
LONG-TERM  
INJURY

RECOMMENDED EXPOSURE

WEEK	SESSIONS	TIME
WEEK 1	SESSIONS 1-3	3 MIN.
WEEK 2	SESSIONS 4-5	4 MIN.
WEEK 3	SESSIONS 6-7	5 MIN.
WEEK 4	SESSIONS 8-9	5 MIN.
WEEK 5	SESSIONS 10-11	5 MIN.

USE TIME: 15 MINUTES

IF YOU TANS WILL APPEAR WITHIN SIX HOURS OF THE  
LAST SESSION. IF YOU DEVELOP A TANNING SURFACE, YOU MAY  
BE AT RISK OF DEVELOPING A TANNING SURFACE. IT IS  
INTENDED TO BE USED ONLY WITH THE DEVICE.

**CONTENTS FOR ASSEMBLY AND OPERATION:**

2     **WARNING LABELS - PLEASE READ**  
8     **WELCOME**  
9     **PACKING LISTS & TECHNICAL DATA**  
11    **BEFORE ASSEMBLY INSTRUCTIONS**  
12    **COMMON QUESTIONS**  
13    **ASSEMBLY INSTRUCTIONS**  
16    **ELECTRICAL REQUIREMENTS & CONNECTIONS**  
16    **TIMER INFORMATION**  
17    **DISPOSAL OF PACKAGING & TANNING LAMP DATA**  
18    **ABOUT OPERATION**  
19    **SAFETY INSTRUCTIONS FOR OPERATION**  
20    **HEALTH DANGERS**  
21    **RECOMMENDED EXPOSURE TIMES**  
22    **FACIAL TANNER EXPOSURE & INFORMATION**  
23    **CLEANING UNIT**  
26    **REPLACING LAMPS**  
28    **TROUBLESHOOTING**  
29    **DISPOSAL OF LAMPS & SPARE PARTS**  
30    **PARTS DIAGRAM**  
31    **PART ID AND REORDER LISTING**  
32    **WIRING DIAGRAMS**



SonnenBräune Headquarters, Showroom & Factory

6362 Battlefield Parkway

Ringgold, Georgia USA

706.937.2005

800.829.6533

Fax 706.937.5609

web: [www.sonnenbraune.com](http://www.sonnenbraune.com)

email: [sales@sonnenbraune.com](mailto:sales@sonnenbraune.com)



Congratulations on the purchase of your SonnenBräune tanning bed. This quality bed is one of the finest crafted, most dependable and highly profitable beds available on the market today. We pride ourselves not only on



you have faith in our product and what we can do for your salon. Your new SonnenBräune tanning bed will help you attract more and more customers by offering advanced SonnenBräune features, and increasing your turn around through faster tan times.

And, no matter where you are in the world, there is a SonnenBräune distributor to serve you. Our worldwide network was developed to serve the global demand for our product. So if you ever have a question regarding your SonnenBräune tanning bed, feel free to call your personal distributor, or contact SonnenBräune by phone or through the internet at [sales@sonnenbraune.com](mailto:sales@sonnenbraune.com). You can also visit our web site for more information about the entire line of SonnenBräune products and the latest innovations at [www.sonnenbraune.com](http://www.sonnenbraune.com).

Thanks for purchasing your SonnenBräune bed... The Solar System beyond

[www.sonnenbraune.com](http://www.sonnenbraune.com)

## Packing List

- 1 x Plastic part, head endcap
- 1 x Plastic part, foot endcap
- 1 x Cushion
- 1 x Accessory bag with screws
- 1 x Assembly and operating instructions with circuit diagram and pairs of sunglasses
- 1 x Packing docket

## BodyScan Product Specifications & Technical Data

BodyScan by SonnenBräune	3500/3 & XT15
Premium Color	Planetary silver
Reflector tubes in the canopy (#/watts)	18 @ 100W
Reflector tubes in the bench (#/watts)	17 @ 100W
BeautyMetic facials in the canopy (#/watts)	3 @ 500W
Mechanical lift and lower of canopy with gas pistons	yes
Electrical supply required	220 volts
Approximate power in watts	5,690W
Recommended breaker rating	40 amps
Solarium tan time)	15 minutes
Pivoting facial filter glass for quick change of lamps	yes
Body cooling from the head section pillar	optional
BodyScan by SonnenBräune	XT10
Premium Color	White/Logo Graphics
Tubes in the canopy (#/watts)	18 @ 100W
Tubes in the bench (#/watts)	17 @ 100W
Mechanical lift and lower of canopy with gas pistons	yes
Electrical supply required	220 volts
Approximate power in watts	3,950W
Recommended breaker rating	30 amps
Solarium tan time)	10 minutes
Pivoting facial filter glass for quick change of lamps	yes
Body cooling from the head section pillar	optional
Electrical component service tray	yes
Appliance measurements completely assembled	88.25" x 35.5"
Approximate ship weight in lbs.	635 lbs.
Appliance construction	steel
Certification code	ETL
Suggested minimum solarium room size	8' x 7'



**Packing List**

- 1 x Plastic part, head endcap
- 1 x Plastic part, foot endcap
- 1 x Cushion
- 1 x Accessory bag with screws
- 1 x Packing docket
- 1 x Assembly and operating instructions with circuit diagram and pairs of sunglasses

**Klassik Series Product Specifications & Technical Data**

Klassik Series	730	730/1
Premium Color	White /Logo graphics	
Tubes in the canopy (#/watts)	15 @ 100W	15 @ 100W
Tubes in the bench (#/watts)	15 @ 100W	15 @ 100W
High pressure facial lamp (#/watts)	n/a	1 @ 500W
Pivoting facial filter glass for quick change of lamps	n/a	yes
Mechanical lift and lower of canopy with gas pistons	yes	yes
Electrical supply (volts/watts)	220/3,320W	220/3,950W
Body cooling from the head section pillar		
Appliance measurements completely assembled	88.25" x 35.5"	88.25" x 35.5"
Approximate ship weight in lbs.	610 lbs.	645 lbs.
Appliance construction	steel	steel
Certification code	FTI	ETL

Suggested minimum solarium room size 8' x 8'

Klassik Series	735	735/3
Premium Color	White /Logo graphics	
Tubes in the canopy (#/watts)	18 @ 100W	18 @ 100W
Tubes in the bench (#/watts)	17 @ 100W	17 @ 100W
High pressure facial lamps (#/watts)	n/a	3 @ 500W
Pivoting facial filter glass for quick change of lamps	n/a	yes
Mechanical lift and lower of canopy with gas pistons	yes	yes
Electrical supply (volts/watts)	220/3,950W	220/5,690W
Recommended breaker rating	30 amps	40 amps
Solarium tan time	20 minutes	20 minutes
Appliance internal cooling in canopy (#/cfm)	5 @ 105cfm	5 @ 105cfm
Appliance internal cooling in bench (#/cfm)	4 @ 105cfm	4 @ 105cfm
Body cooling from the head section pillar	optional	optional
Appliance measurements completely assembled	88.25" x 35.5"	88.25" x 35.5"
Approximate ship weight in lbs.	635 lbs.	685 lbs.
Appliance construction	steel	steel
Certification code	ETL	ETL
Suggested minimum solarium room size	8' x 7'	8' x 7'

## > Before Assembly

The assembly instructions provide important safety directions and information necessary for the correct assembly of the unit. Please read the assembly instructions completely and carefully.

### For Your Safety During Assembly

- Danger of injury by sharp edges. Be sure to wear safety shoes and gloves when assembling the unit.
- Danger of electrocution. Never take the safety equipment out of operation.  
Never bypass the safety equipment. Ineffective safety equipment could cause harm.
- Work on the electrical supply may only be performed by qualified electricians.  
This work must be performed in compliance with electrical rules and regulations.
- Use only original fuses with the specified voltage and current ratings.
- When installing the unit, ensure that the color codings of the plugs and sockets match.
- The voltage of the power source must conform to the specifications of SonnenBräune, Inc.
- Do not put the unit into operation if the power lead or the unit is damaged.
- Protect the cables against heat and moisture.

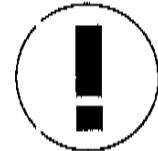

### Transport Damage

Check that the unit has been delivered in an good, undamaged condition immediately upon arrival of shipment. Inform the delivery service of any transport damage or missing items. Compare the delivered parts with the packing list. If there is damage, the damage report should be made immediately, at least within four days of delivery. The notification period begins on the date of delivery. For easier clarification, damage should be photographed.

### Notes on Transport Before Assembly

- When transporting, loading or unloading the unit, special care and consideration is necessary. Never use force.
- Do not transport the unit in an assembled condition.
- Only remove the packing material and the transport braces at the final location.
- Replace damaged or worn parts.
- Use only original parts.

### Installation Site

- Place the unit in a dry room protected against water spray and drops.  
The air humidity must not exceed 70% at the maximum permissible room temperature of 82.4° F
- The ceiling of the room in which you intend to install the unit must be open for ventilation.
- Always ensure sufficient air circulation in the room.

### Intended Use

The tanning unit is intended exclusively for cosmetic tanning of the human skin. Other use is not intended. The manufacturer will not accept liability for damages caused by misuse.

### The intended use includes:

- The observation of all notes in the assembly and operating instructions.
- Compliance with the specified cleaning and maintenance work.

### Assembly Directions

Depending on your room space, the unit must first be dismantled in at least two components (canopy / bench) before the actual assembly. Instructions for this are to be found on the following pages.

## > Common questions

### **Customer responsibility when receiving shipment of bed.**

Accepting your tanning bed shipment and unpacking the contents deems the contents sole responsibility of the recipient. Should the boxes or crates be damaged, inspect the contents prior to accepting shipment. If damage exists, contact the delivery carrier and your distributor immediately. SonnenBräune is not responsible for damage that has occurred during shipping, unpacking, or installation of bed. If damage has occurred while in route to destination, the carrier is responsible.

### **Contact the carrier first, then your SonnenBräune distributor.**

### **What to expect when special arrangements have been made to include installation with your purchase.**

If special arrangements have been made to include the installation, the tanning bed will be delivered to the sight and assembled in the room. All electrical connections from the bed to the ballast trays will be made by the installer. At this point the bed is ready for the electrician to connect power (buck-booster) to the unit. If all the electrical is done (proper voltage and wire supplied) the installer may connect power to the unit.

### **What's not included in the tanning bed installation?**

There will be no electrical work performed by the installer except on the tanning unit. The installer will not wire the Buck-Boost transformers. The installer will not connect exhaust hoses to the building (Only to the tanning unit). There will be no modification made to the building (walls, ceiling, etc.) by the installer.

### **The End-User must supply proper room size and access to the room.**

SonnenBräune will not be responsible for dents or scratches to the unit when proper room size and access to the room is not provided (to be determined by the installer). SonnenBräune will not be responsible for damage to the unit during shipping or while being installed by anyone other than a SonnenBräune Certified Installer.

### **Buck-Boosters**

Buck-Boosters will be supplied by SonnenBräune

## Assembly Parts List

All electrical testing and installation of parts must be performed by a certified electrical technician. Your electrician should contact SonnenBräune's service department for instructions prior to making any adjustments or changes.

After the unit has been removed from its packaging, the bench must be installed in the installation site. The room size needs to be sized adequately to accommodate at least three installation workers... located in front and behind the bench in order to attach the canopy.

1. Leg Assembly
2. & 3. Facade Pivot
4. Facade Camlock
5. Facade Flange
6. Leg Pads
7. Leg Support
8. Brake
9. Flat Washer & Brake Bolts
10. Hinge Arm
11. Lock Washers & Hinge Bolts
12. Main Pivot Bolt
13. Flat Washer
14. Piston
15. Piston Clip
16. Brake Adjustment Tool
17. Canopy End-Cap
18. Bench End-Cap
19. Leg End-Cap
20. Leg Panel

Diagram #1

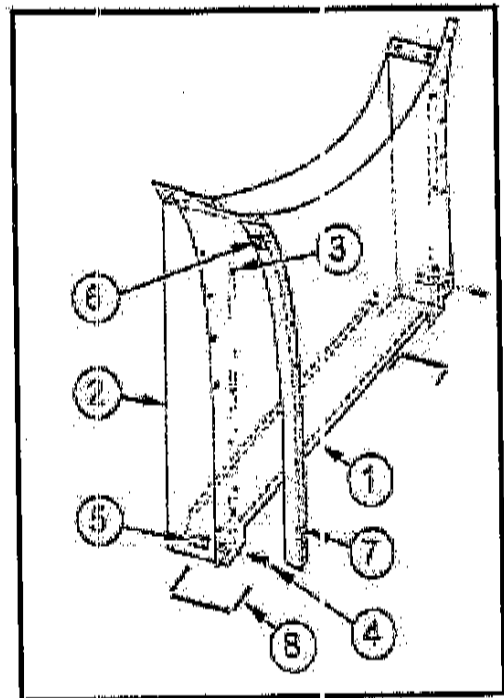

Diagram #2

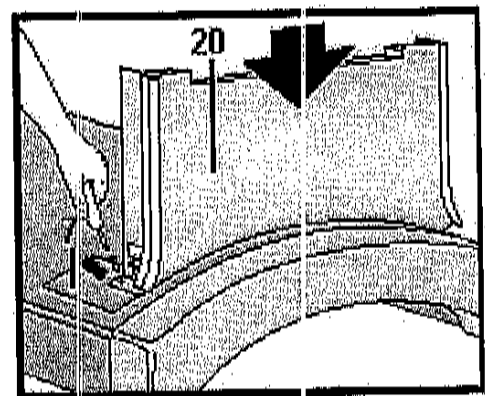

Diagram #3



**Step 1)** Attach facade bracket to leg assembly (Diagram 1, #5). Attach pivot point and cam locks for facade mounting (Diagram 1 # 2,3 & 4). Next install leg pads (Diagram 1, #6).

**Step 2)** Install the two legs with screws supplied to the bench. **CAUTION** - care should be taken when installing the legs. The flanged edge of the leg must be installed to the direction of the end caps, away from the ballast tray (Diagram 2, #20). **NOTE** - special support plate must be installed between leg assembly and body assembly

**Step 3)** Set the bench up in the position...

Diagram #4

Step 5) Install the brakes (Diagram #4, 8) in the hinge arm (Diagram #4, 10) with adjustment screw aligned with the hole in the arm.

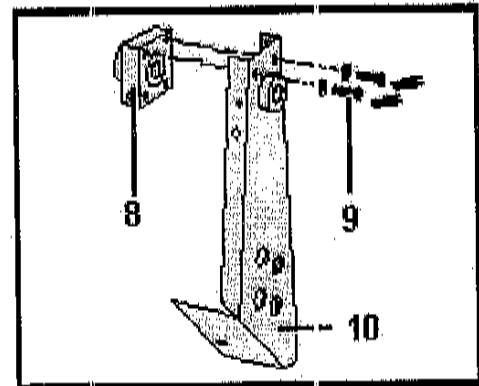

Diagram #5

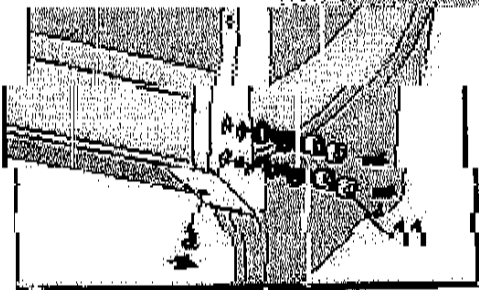

Diagram #6



Step 9) Insert the brake boss that protrudes from each end of the arm into the previously installed brakes, one end at a time.

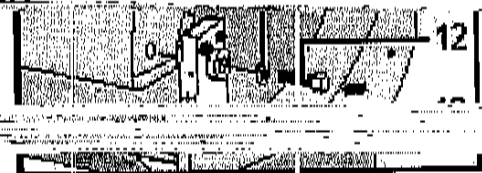

Diagram #8

**Step 11)** Now, install the pistons and piston clips(Diagram #8, 14 &15)

Diagram #8

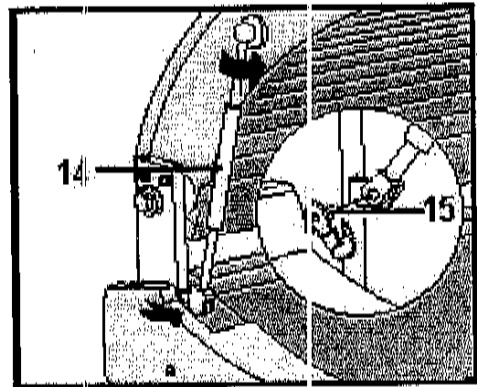
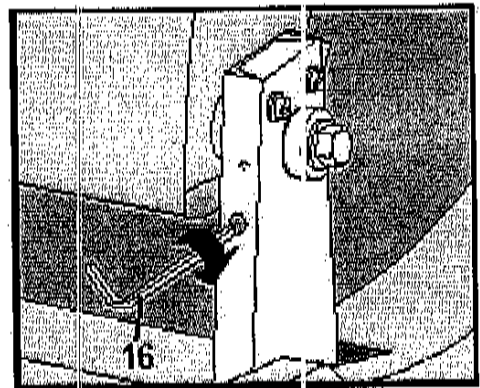
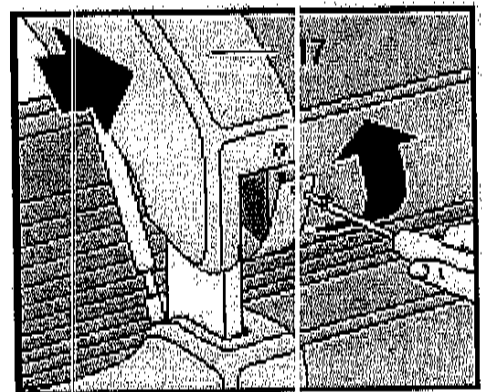

Diagram #9



**Step 12)** Adjust the brakes with tool ( Diagram #9, 16)  
**Caution:** When adjusting brakes, do not over tighten. Only light adjustment is needed, the top should raise and lower smoothly.

Diagram #10



**Step 13)** Now, install Canopy end caps. (Diagram #10, 17)

#### Power drawer installation:

**Step 14)** Insert power trays under bench.

**Step 15)** Connect the power leads from the bench and canopy as marked in color coded sequence.

**Step 16)** Turn on power switch which is mounted on ballast tray.

**Step 17)** Test unit, then Install facade using facade camlock that is provided (diagram #1, 4).

Call your SonnenBräune representative in the event you have difficulty with any of the instructions above. The most common problems to check for in the event your tanning bed does not function are:

- Improper connections to the power tray.
- Inadequate power supply.

## Electrical Requirements & Connections

Your new tanning bed must operate on 220 VAC 60 Hz single phase only. A qualified electrician must be used to connect this appliance to your electrical supply. Your SonnenBräune bed must run between 220 to 230 volts. You should not operate your unit on voltage outside of this range, because you will damage the bed and void the warranty. Please give this information to your electrician and have him/her take a digital voltage reading on your incoming power to determine the exact voltage. If your voltage is not between 220 and 230 volts, you need to purchase a "buck boost" transformer. They are available from SonnenBräune. The purpose of this transformer is to regulate your voltage to correct the level. This is very important to ensuring that your bed is operating properly and in avoiding future problems. To avoid over heating of the unit, do not cover the air vents.

### Timer Plug

- Connect the Timer Plug to the Timer port that is located on the left tray, close to the right end.

(see Diagram 8)

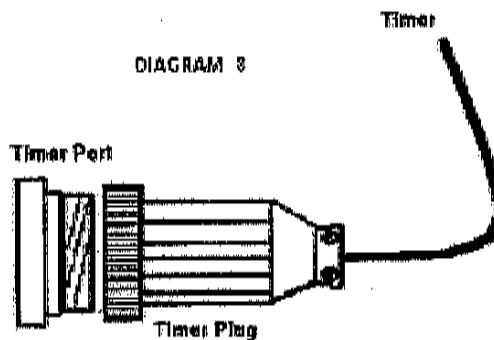

**3500/3:****Original Spare Parts**

Canopy Tanning Lamps - 18 x BodyScan XR® 100w or Cosmolux VLR® 1881 04/100w

Bench Tanning Lamps - 17 x BodyScan XR® 100w or Cosmolux VLR® 1881 04/100w

Intensive Facial Tanner - 3 x Philips Cleo HPA/30 S 400W (behind BeautyMetic Facial Glass)

**Klassik Models:****Original Spare Parts**

Canopy Tanning Lamps - 15 or 18 x BodyScan X PLUS® 100w

Bench Tanning Lamps - 15 or 18 x BodyScan X PLUS® 100w

Intensive Facial Tanner - 1 or 3 x Philips Cleo HPA/30 S 400W (730/1 or 735/3 models only)

**Model: XT15****Original Spare Parts**

Canopy Tanning Lamps - 15 or 18 x BodyScan XR PLUS® 100w

Bench Tanning Lamps - 15 or 18 x BodyScan XR PLUS® 100w

Intensive Facial Tanner - 1 or 3 x Philips Cleo HPA/30 S 400W

**Models:XT10****Original Spare Parts**

Canopy Tanning Lamps - 15 or 18 x CosmoLux Hi-Tan 100W

Bench Tanning Lamps - 15 or 18 x CosmoLux Hi-Tan 100W

**Disposing of the packing**

With the exception of wooden materials, packing materials and packing aids can be recycled and should always be reused.

Paper, cardboard and corrugated cardboard packing materials, plastic packing parts and metal packing parts should be deposited in the appropriate collection containers. If these are not in place in your area, you can put these materials in with normal household waste.

We use only plastics capable of recycling as packing aids, e.g.

**The symbols read:**

**PE for polyethylene (02=PE-HD; 04PE-LD)**

**PP for polypropylene (05)**

**PS for polystyrene (06)**





**Proper Operational Procedures for Your Tanning Bed**

**AVOID EYE DAMAGE.** Always wear proper protective eye wear. Eyes should be kept closed.

**Easy Access Control Buttons:**

Your SonnenBräune tanning bed is equipped with three easy access control buttons to operate special features on your unit. See diagram for operational procedures for each control button function.

**Remote Timers:**

**BodyScan 3500/3 & XT15**

Equipped with a remote timer that has a 15 minute maximum exposure time.

**BodyScan XT10**

Equipped with a remote timer that has a 10 minute maximum exposure time.

**Klassik Series**

Equipped with a remote timer that has a 20 minute maximum exposure time.

The remote timer can be set to the desired minute mark to activate the sunbed and start the session. The timer also serves as an emergency termination switch. To terminate emission of ultraviolet radiation, simply press the Start/Stop Button.

The unit is also equipped with an ON/OFF switch as shown. (Diagram #10, button A) This button must be activated in order to turn the tanning bed on. This switch can also serve as a termination switch. To terminate a tanning session, simply turn the switch to the "OFF" position.

**High Pressure Facial Tanners**

If your SonnenBräune bed is equipped with high pressure facials, please refer to (Diagram #10, button C) for operational procedures for your easy access control button.

**Customer Cool System**

The customer cooling fans are located at the end of the tanning bed for maximum comfort. (Diagram #10 button B) Each is built with 9 internal fans - 5 @ 105 cfm in the canopy and 4 @ 105 cfm in the bench. Your bed may include the optional body cooling from the head section pillar. (Diagram #11)

Diagram #10

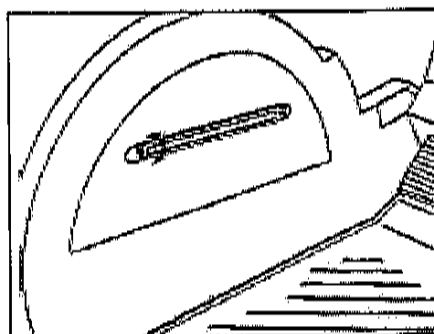
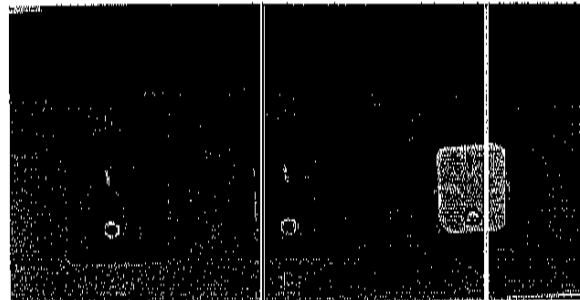

DIAGRAM 11

See Page 21 for the recommended exposure schedule - regulated by the FDA.

>Operating Instructions

This unit complies with the accepted rules of technology and the pertaining ETL safety regulations.

This unit is screened in compliance with the EMT guidelines (electromagnetic tolerance).

**SAFETY DIRECTIONS**

Observe the safety directions in the assembly instructions. Read and follow exposure times and recommendations as seen on warning labels for each bed - example of warning label shown on right.



**General Dangers**

- Never allow unsupervised children to use the unit.
- Use the unit only when it has no visible deficiencies.
- Use the unit only when all safety and protective devices such as facial glass is installed and in order.
- Materials which fade in sunlight (e.g. paintings) should not be exposed to the UV light of this unit.

Never cover the ventilation slots or hot air outlet openings of the cooler fan. If the fan fails, switch off the unit immediately.

**Danger of Burns**

- Elements of the unit get hot! Never touch the facial glass or lamps during tanning.
- The unit must fully cool before cleaning or maintenance work is done.

**CAUTION!**

Do not operate this equipment without all Guards, End-caps, Filters, Front Panel, etc. installed on unit. Doing so can cause serious damage to your tanning bed!

**DANGER:** ULTRAVIOLET RADIATION. FOLLOW INSTRUCTIONS. AVOID MEDICATION OR COSMETICS MAY INCREASE YOUR SENSITIVITY TO THE ULTRAVIOLET RADIATION. REPEATED EXPOSURE MAY CAUSE PREMATURE AGING OF THE SKIN AND SERIOUS DAMAGE TO THE SKIN AND EYES. CONSULT PHYSICIAN BEFORE USING SUNLAMP IF YOU ARE USING MEDICATIONS OR HAVE A HISTORY OF SKIN PROBLEMS OR BELIEVE YOURSELF ESPECIALLY SENSITIVE TO SUN LIGHT. IF YOU DO NOT TAN IN THE SUN, YOU ARE UNLIKELY TO TAN FROM THE USE OF THIS PRODUCT.

**WEAR PROTECTIVE EYEWEAR; FAILURE TO DO SO WILL RESULT IN SEVERE BURNS OR LONG-TERM DAMAGE TO THE EYES**

**CAUTION! EXPOSURE POSITIONS OTHER THAN SPECIFIED CAN BE DANGEROUS AND ARE NOT RECOMMENDED**

THIS DEVICE IS INTENDED TO BE USED BY ONE PERSON AT A TIME. YOU MAY LIE DIRECTLY ON TANNING SURFACE.

THE MINIMUM EXPOSURE POSITION IS 0.5 IN. (1.27CM) FROM THE LAMP'S SURFACE (PRESET BY THE MANUFACTURER). READ THE INSTRUCTION BOOKLET BEFORE USING THIS DEVICE.

SKIN TYPE II - THIS IS THE INDIVIDUAL THAT USUALLY BURNS EASILY AND SEVERELY, TANS MINIMALLY OR LIGHTLY AND PEELS.

SKIN TYPE III - OFTEN REFERRED TO AS "AVERAGE" COMPLEXION, BURNS MODERATELY AND TANS ABOUT AVERAGE.

SKIN TYPE IV - THIS INDIVIDUAL BURNS MINIMALLY, TANS EASILY AND SUBSTANTIALLY.

SKIN TYPE V - THIS INDIVIDUAL'S SKIN RARELY BURNS, TANS EASILY AND SUBSTANTIALLY.

FOR PARTS AND SERVICE CALL:  
SonnenBraun, Inc.  
Ridgely, GA  
1-800-829-6533

SKIN TYPE	WEEK 1		WEEK 2		WEEK 3		WEEK 4		BI-WEEKLY MAINTENANCE SESSIONS
	1	2	1	2	1	2	1	2	
II FAIR	3 MIN.	3 MIN.	3 MIN.	3 MIN.	3 MIN.	3 MIN.	3 MIN.	3 MIN.	12 MIN.
III MEDIUM	3 MIN.	3 MIN.	3 MIN.	3 MIN.	3 MIN.	3 MIN.	3 MIN.	3 MIN.	12 MIN.
IV DARK	3 MIN.	3 MIN.	3 MIN.	3 MIN.	3 MIN.	3 MIN.	3 MIN.	3 MIN.	15 MIN.
V VERY DARK	3 MIN.	3 MIN.	3 MIN.	3 MIN.	3 MIN.	3 MIN.	3 MIN.	3 MIN.	15 MIN.

RE SCHEDULE: WEEK 4 SESSIONS 11-15

MAXIMUM USE TIME: 15 M

FIRST APPLICATION: PROVIDED YOUR SKIN IS CAPABLE OF DEVELOPING A TANNING SESSION. THIS SYSTEM IS INTENDED TO SYSTEM BODYSCAN XR PLUS 771/100W B21M OR COSMO LUX VLR 13310100V E W

THIS PRODUCT IS IN CONFORMANCE WITH PERFORMANCE STANDARDS FOR SUNLAMP PRODUCTS UNDER NO. 21 CFR 50.100 CHAPTER J.

**Health Dangers**

- It is essential that you do not exceed the initial and maximum tanning times specified on page 21.

**Attention: the tanning times are based on the skin type (see table of tanning times).**

- If you have a skin disorder, consult your doctor prior to tanning.
- Do not use UV radiation units if you have an abnormal skin reaction caused by intensive sunlight.
- If irritations or blisters appear on the skin after tanning, consult your doctor.
- Persons with pacemakers should consult their doctor to determine whether exposure to radiation in UV radiation is harmless to them.
- **Protect your eyes. Always use suitable eye protection during tanning. Close your eyes during tanning. Unprotected**

**UV Radiation and Drug Interactions**

- Medicines which seriously increase UV sensitivity are antibiotics, psychopharmaceuticals, diuretics, etc. Persons taking these types of drugs have a lower threshold for tanning, phototoxic and photoallergene skin reactions. Consult your physician prior to using a tanning bed.

**Examples of Medicines Which Can Cause Increased Sensitivity to UVRadiation**

(phototoxic and photoallergene reactions):

**> External Applications (brand names)**

- Dermatics
- Antimykotics (Multifungin)
- Photochemotherapeutics (Meladinin)

**> Internal Applications (brand names)**

- Antidiabetics (Euglucon, Rastinon)
- Chemotherapeutics
- Antibiotics (Tarivid, Ciprobav, Nogram)
- Antimalaria agents / antirheumatics (Resochin)
- Antimalarial agents (Lariam)
- Neuroleptics / antihistamines (Atosil, Neurocil, Psyquil, melleril, Taxilan)
- Diuretics (Esidrix, DytideH, Moduretik)
- Antihistamines (Soventol)
- Antitussives (Benadryl)

**Observe the safety directions in the assembly instructions.****General Dangers**

- Never allow unsupervised children to use the unit.
- Use the unit only when it has no visible deficiencies.
- Use the unit only when all safety and protective devices such as filter plates are installed and in order.
- Materials which fade in sunlight (e.g. paintings) should not be exposed to the UV light of this unit.

>Operating Instructions



The tanning units are equipped with special UV radiation lamps which generate little UVB radiation for the development of pigments and a high proportion of mild UVA tanning radiation.

- The skin is tanned inside the shortest possible time by the optimum composition of the radiation and the for tanning.
- After tanning, it is advisable to use a skin lotion.
- The thickness of the skin is not equal on all parts of the body. This results in differing light sensitivity. In the region of thin parts of the skin (e.g. the female breast), the tanning time should be reduced or sensitive parts of the skin should be covered when a part of the tanning period has expired.
- The attainment of an optimum tan depends on the skin type. This requires a tanning series of five to 10 sessions. Approximately two sessions per week are sufficient to maintain the achieved tan.
- If the skin reacts sensitively (skin tension), you should reduce the tanning period or temporarily interrupt a tanning session.
- In cases of insomnia, the sessions should be taken in the mornings.
- Overly excessive UV sessions in sunlight or with UV units can cause damage to the skin or eyes.
- The skin can become sunburnt after excessive exposure to radiation. Excessive UV sessions in sunlight or with UV units can lead to premature aging of the skin and to an increased risk of skin tumors.

**Skin Types**

The human skin reacts differently to exposure to UV light depending on the skin type. The recommended tanning times specified in the table are not generally applicable, but depend on the skin type. To find the correct tanning time for you (see table of tanning times), choose the appropriate skin type for yourself.

**Skin type II:** This is the individual that usually burns easily and severely, tans minimally or lightly and peels.

**Skin type III:** Often referred to as average complexion, burns moderately and tans about average.

**Skin type IV:** This individual burns minimally, tans easily and above average.

**Skin type V:** This individual's skin rarely burns, tans easily and substantially.

SKIN TYPE	RECOMMENDED EXPOSURE SCHEDULE:					BI-WEEKLY MAINTENANCE SESSIONS
	WEEK 1 SESSIONS 1-3	WEEK 2 SESSIONS 4-6	WEEK 3 SESSIONS 7-10	WEEK 4 SESSIONS 11-15		
II FAIR	3 MIN.	6 MIN.	8 MIN.	10 MIN.	12 MIN.	12 MIN.
III MEDIUM	3 MIN.	6 MIN.	8 MIN.	10 MIN.	12 MIN.	12 MIN.
IV DARK	3 MIN.	8 MIN.	10 MIN.	15 MIN.	18 MIN.	18 MIN.
V VERY DARK	4 MIN.	12 MIN.	16 MIN.	20 MIN.	20 MIN.	20 MIN.

**MAXIMUM USE TIME: 20 MINUTES**

3500/3  
XT15

SKIN TYPE	RECOMMENDED EXPOSURE SCHEDULE:				E8-WEEKLY MAINTENANCE SESSIONS
	WEEK 1 SESSIONS 1-3	WEEK 2 SESSIONS 4-6	WEEK 3 SESSIONS 7-10	WEEK 4 SESSIONS 11-15	
II FAIR	3 MIN.	4 MIN.	5 MIN.	6 MIN.	7 MIN.
III MEDIUM	3 MIN.	4 MIN.	5 MIN.	6 MIN.	7 MIN.
IV DARK	3 MIN.	5 MIN.	5 MIN.	7 MIN.	10 MIN.
V VERY DARK	3 MIN.	5 MIN.	5 MIN.	7 MIN.	10 MIN.
MAXIMUM USE TIME: 10 MINUTES		XT10			

This exposure schedule provides information on tanning times, depending on the skin type and specific unit.

- Do not exceed the specified tanning times.
- In the first 50 to 80 hours of operation, the unit generates approximately 20% higher power. Reduce the session times specified in the table by approximately 20%.
- The interval between two sessions should be at least 48 hours.
- Avoid additional sunbathing on the days of the sessions.

#### Facial Tanner (models 3500/3, 730/1, XT15 & 735/3)

The Facial Tanner is equipped with a higher radiating power than the other lamps. This attains a more intensive tanning of the facial skin.

See safety warning labels on page 2 - 6 of this manual.

Danger of injury by intensive radiation and high brightness. Never look into the lamps during operation. Use the UV blocking eyewear provided.

Danger of skin injury by excessively long tanning. The maximum tanning time is specified in the table of tanning times.

The filter glass of the tanning bed becomes hot. Avoid all contact during tanning. Never tan without facial glass. If the tanning unit has visible deficiencies (e.g. filter or timer defective), the unit must not be put into operation.

The tanning times specified in the tables are recommended tanning times and apply only to the lamp types listed in the tables.

Danger of Burns. Observe the lamps with which your unit is equipped. If tanning lamps of other manufacturers or tanning lamps with higher ratings are used, skin injuries can be caused. The specified tanning times in the tables are then no longer valid.

Danger of skin injuries by excessively frequent sessions.

**IN MOST CASES, TANNING WILL APPEAR WITHIN SIX HOURS OF THE FIRST APPLICATION, PROVIDED YOUR SKIN IS CAPABLE OF DEVELOPING A TAN. A MOISTURIZER MAY BE USED AFTER EACH TANNING SESSION. THE KLASSIK SERIES BEDS ARE INTENDED TO BE USED ONLY WITH THE WOLFF SYSTEM BODYSCAN X PLUS® F71 BIPIN 100W AND PHILIPS CLEO HPA/30 SIV 400W. THE BODYSCAN 3500/3 IS INTENDED TO BE USED ONLY WITH THE BODYSCAN XR PLUS® F71/R BIPIN 100W or COSMOLUX® VLR 1881 04/100W AND PHILIPS CLEO HPA/30 SIV 400W.**

The specified tanning times apply only for the following high-pressure and tanning lamps – in corresponding quantities:

**3500/3:**

- Canopy Tanning Lamps - 18 x BodyScan XR® 100w or Cosmolux VLR® 1881 04/100w
- Bench Tanning Lamps - 17 x BodyScan XR® 100w or Cosmolux VLR® 1881 04/100w
- Intensive Facial Tanner - 3 x Philips Cleo HPA/30 S 400W (behind BeautyMetic Facial Glass)

**Klassik Models:**

- Canopy Tanning Lamps - 15 or 18 x BodyScan X PLUS® 100w
- Bench Tanning Lamps - 15 or 18 x BodyScan X PLUS® 100w
- Intensive Facial Tanner - 1 or 3 x Philips Cleo HPA/30 S 400W (730/1 or 735/3 models only)

**Model: XT15**

- Canopy Tanning Lamps - 15 or 18 x BodyScan XR PLUS® 100w
- Bench Tanning Lamps - 15 or 18 x BodyScan XR PLUS® 100w
- Intensive Facial Tanner - 1 or 3 x Philips Cleo HPA/30 S 400W

**Models: XT10**

- Canopy Tanning Lamps - 15 or 18 x CosmoLux Hi-Tan 100W
- Bench Tanning Lamps - 15 or 18 x CosmoLux Hi-Tan 100W

**CLEANING**

**DANGER of electrocution.** Always disconnect main power before cleaning only.

**Cleaning the High Pressure Facial Glass**

Clean the glass with a damp cloth. Use only recommended cleaners.

- Remove the canopy acrylic



Swivel out the filter plate with the provided strips (see Fig. 22).

**Material breakage**  
Ensure when swinging the filter plate out that it does not fall out of the profiled strips.

- The filter plate can now be cleaned or replaced as required.

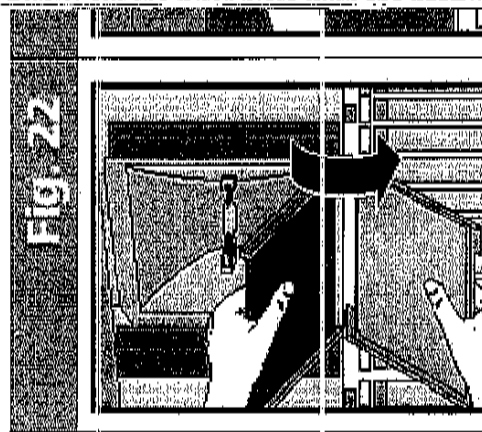

**Cleaning the Acrylic in the Canopy**

Clean the acrylic with a damp cloth and use only recommended cleaners.

- Open the three catches with the aid of a coin, pressing lightly on the glass with the other hand to prevent it from falling onto the bed acrylic.
- Clean the acrylic from both sides and replace it in the reverse order. (Diagram #13, 1)

**Cleaning the Bench Acrylic**

- Open the bed catches with the aid of a coin.
- Then lift the bench acrylic and stand it on its end.
- After cleaning the inside, replace the acrylic, observing that the guide lugs of the acrylic retaining strip are engaged in the provided recesses.
- Then lower the bench acrylic and lock the catches. (Diagram #13, 2)

Operate the unit only when all safety and protective equipment such as the acrylic is reinstalled.



**WARNING!**

If you notice damage to the tanner (filter, acrylic or timer defects) do not operate unit under any circumstances!

**DANGER OF BURNS**

Some parts may be very hot after operation, do not touch.

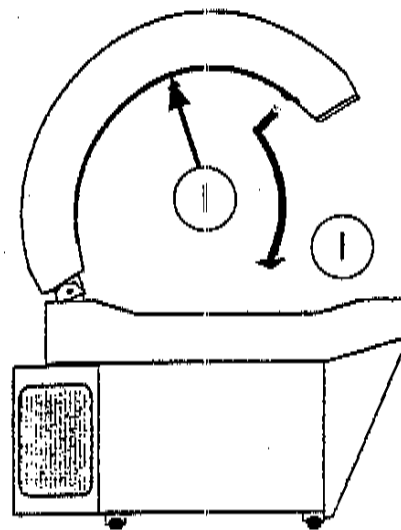
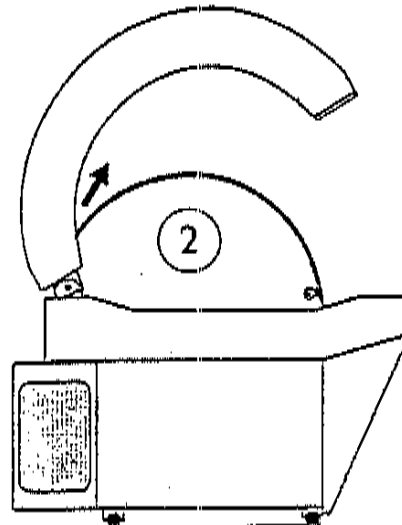

DIAGRAM 13



**> MAINTENANCE**

Your tanning bed will require simple maintenance when necessary to maintain proper operation of the unit. Always ensure that your acrylic shields are clean, otherwise the tanning performance will be reduced. For cleaning, use a soft rag and clean the reflectors, as well as the lamps for dust particles. Do not use alcohol or ammonia based cleaners or any coarse abrasive agents.

- The acrylic shield is a special version with 100% UV remittance ability. If it must be replaced, use only a SonnenBräune certified replacement shield.
- When maintaining operation of the unit, replace only with SonnenBräune certified replacement parts.

**Warning**

SonnenBräune will not be responsible for improperly maintained, old or worn out parts or uncertified replacement parts. Only replace with SonnenBräune certified replacement parts.

**Warning**

SonnenBräune will not be responsible for equipment that has been outfitted without approved SonnenBräune lamps or FDA equivalent.



**Warning:** If parts made by other manufacturers are used, this can influence the performance and functions of the unit.

Never use normal florescent lamps in the unit.

Use only original spare parts.

Information on the lamps. The tanning lamps can have different shades of color. After long operation, dark spots can occur at the ends of the lamps. This has no effect of the performance and life of the lamp.



**Danger of burns**

The high-pressure lamp and the filter plate get very hot. Allow the elements to cool down fully before you replace them or clean them.

- Open the canopy.
- Remove the plate of the canopy as described in the "Cleaning" section.
- Undo the two screws in the filter plate frame (see Fig. 21).
- Swivel out the filter plate with the profiled strips (see Fig. 22).

**Material breakage**

Ensure when swinging the filter plate out that it does not fall out of the profiled strips.

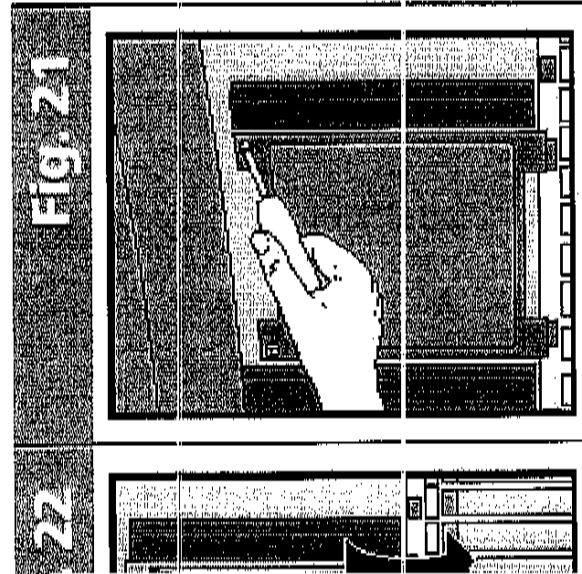

Ensure when replacing new high-pressure

lamps that you do not

touch them with your fingers.

Protect the high pressure lamp by

holding it with a dry cloth.

Clean a high-pressure lamp that has got dirty with methylated spirits.

- Replace the defective high-pressure lamp and put a new one in the holder. Installation is done in the reverse order.

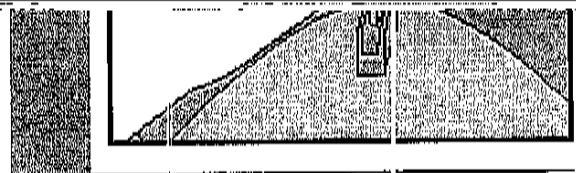

**Replacing the Reflector Lamps**

Before beginning to replace the reflector lamps, switch off the unit.

- Fold the canopy open.
- Open the filter flap of the unit case.
- Switch off the main power.

Begin by removing the acrylics as described in chapter "Cleaning" on page 24. The reflector lamps can then be removed by rotating them 90° in either direction (see Figure D).

When inserting the reflector lamps, please observe that the coating points towards the housing and that the marking on the reflector lamp is aligned with the socket (see Figure E).

Figure D

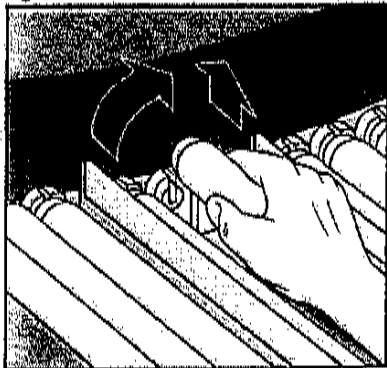
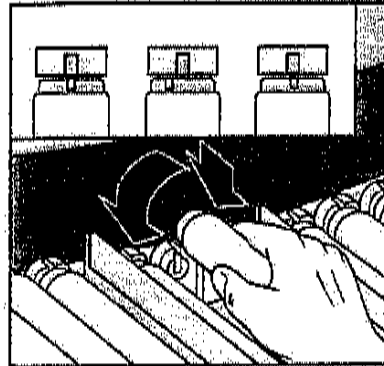

Figure E



## >TROUBLESHOOTING

If your unit does not operate satisfactory, several helpful tips are listed below.

### **What to do when the unit will not start.**

Your SonnenBräune tanning bed has been equipped with certain safety devices that will not allow the unit to operate under certain conditions that may damage your investment. Here is a list of troubleshooting tests in the event your tanning bed will not start.



All electrical testing and installation of parts must be performed by a certified electrical technician. Your electrician should contact SonnenBräune's Service Department prior to making any adjustments.

All repairs must be performed by a SonnenBräune approved electrical technician. All warranty conditions could be voided if this procedure is not followed.

- Check all safety switches and also check the circuit breaker in your breaker panel to make sure it is on.
- Check the On/Off switch on the unit. Make sure it is on.

### **What to do when the tanning bed will not start when the cooling fans are running.**

Your SonnenBraune bed is equipped with a safety device that will not allow the unit to run in the event that the air filtering system becomes clogged with lint or other materials. Prior to notifying your electrician, remove all filters, clean and reinstall. The unit should start at this point. In the event that it does not, call your SonnenBräune service department for further instructions.

### **What to check when one or several lamps do not burn.**

- Turn the power off.
- Remove the acrylic to inspect lamps and connections.
- Check to see if the lamp is properly fitted.
- If it still will not work, replace the defective lamp with a new lamp. If the new lamp lights, it can be assumed that the old lamp is bad.
- If the lamp still doesn't work, contact your SonnenBräune service representative.

### **What to do when you are not satisfied with your tan.**

- Review the exposure schedule on page 21.
- Check the exposure positioning. The distance between the tanning surface and body should be two to four inches. In no event should the exposure position be less than two inches between the body and the tanning surface. However, you may lie directly on the tanning surface of the bench.
- Check your power supply. Refer to page 16, and the section referring to "Electrical Requirements and Connections."
- Review section on "Cleaning and Maintenance" starting on page 23. The tanning performance of your tanning bed will be greatly reduced when these procedures are not followed.
- Check the hours on your lamps. They may need replacing.

## > ENVIRONMENTAL CONSERVATION AND SPARE PARTS

### Disposal

The separate, environmentally compatible disposal of materials or material residues promotes the reuse of valuable materials.

The reflector lamps should not be put in household waste, but should be disposed of separately (special waste). The lamps must not be destroyed before disposal.

The disposal of wastes from private households and the commercial sector is possible through the public special waste collection points.

Information on disposal can be obtained from your waste department.

### Spare Parts

Use only manufacturer approved spare parts as shown on parts list.

If spare parts from other manufacturers are used, this can affect the performance of the unit, and your warranty.

### Please Read:

#### > REPAIRS AND WIRING DIAGRAMS

##### Diagram

The following are wiring diagrams that pertain to the BodyScan 3500/3 tanning bed or the Klassik Series beds produced by SonnenBräune. This is meant to be a resource when needed for technical repair. Diagrams are subject to change without notice, nor is notification to previous owners the responsibility of SonnenBräune, Inc.



**DO NOT ATTEMPT TO REPAIR** your SonnenBräune bed without first notifying your distributor or the SonnenBräune Service Center so an evaluation of electrical service may be determined. Provide this diagram to the certified technician if necessary.

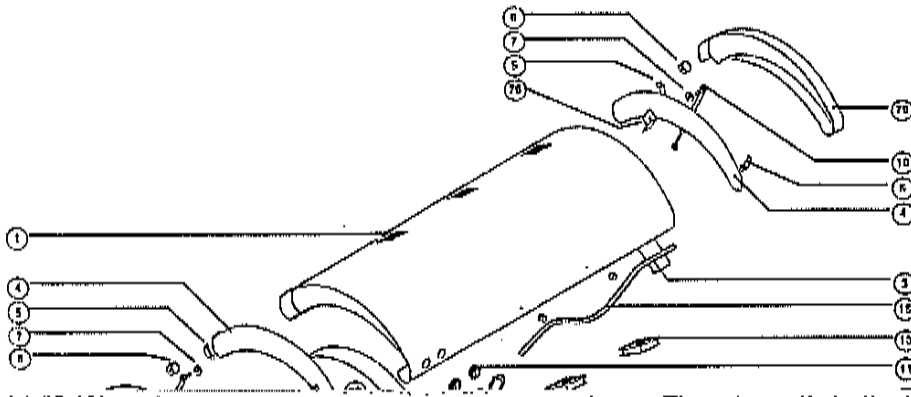

SonnenBräune's tanning beds incorporate a comprehensive program for service to keep your bed up and running with as little down time as possible.

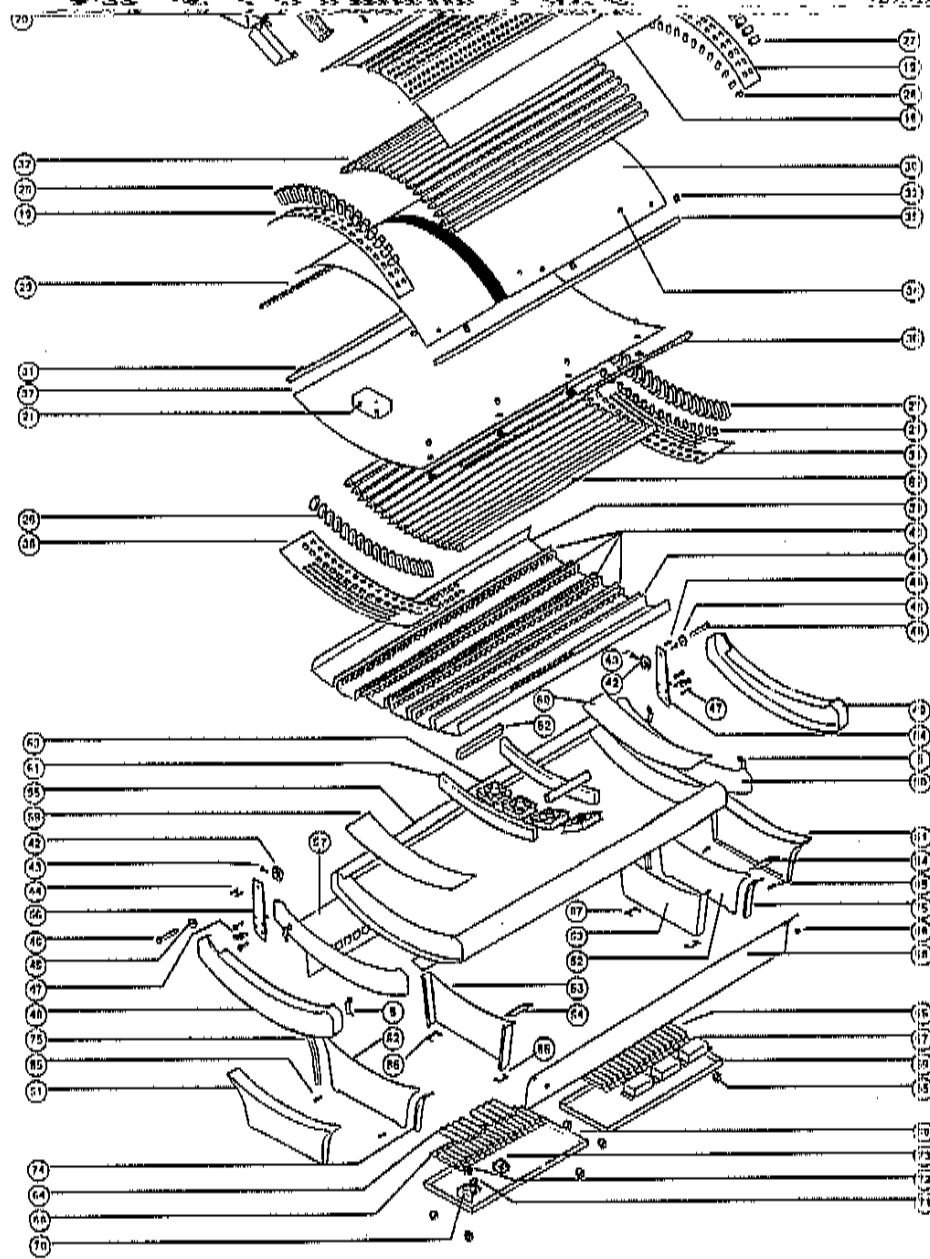

calling your distributor or SonnenBräune's service center.

By referring to parts as they are named and numbered on the list, we can process your order quicker for shipment.

\* Please note that some models may not include the facial tanner parts shown here.

REF.#	PART #	PART NAME	REF.#	PART #	PART NAME
1	144359005	CANOPY	63	8460B	BOX FAN
2	144359012	METAL DECK PLATE - CANOPY	64	1023	CAPACITOR
3	144359011	METAL DECK PLATE - CANOPY	65	NO#	CASTER
4	144359006	METAL END PLATE - CANOPY	66	2188	BALLAST, 100W
5	143265023	METAL MOUNT FOR END CAP	67	11097	BALLAST, 500/400/310W - FACIAL
6	144359001	END CAP, CANOPY - LEFT	68	143266017	LEGS FOR BALLAST TRAY
7	144359033	PISTON MOUNTING WASHER	69	143265026	BALLAST TRAY SHEET
8	144359032	PISTON MOUNTING DISK	70	143197097	MNT. BRACKET, HOUR METER
10	850N	PISTON 850N	71	NO#	SWITCH FOR BALLAST TRAY
11		ON/OFF SWITCH	72	NO#	HOUR METER
12		SWITCH FRAME	73	1014	CONTACTOR
13	8460B	BOX FAN, 230VOLT	74	143266009	FACADE MOUNTING PLATE
14	144359034	SPACER FOR HANDLE	75	143266010	FACADE MOUNTING PLATE
15	144359029	HANDLE	76	144359037	PISTON BRACE
16	144359020	REFLECTOR, CANOPY - BACK	77	144354038	FACIAL BUCKET BRIDGE - FRONT
17	144359019	REFLECTOR, CANOPY	78	NO#	FACIAL MOUNTING KIT
18	144359018	REFLECTOR, CANOPY - FRONT	79	144359002	END CAP, CANOPY - RIGHT
19	144359010	LAMP BRIDGE, CANOPY	80	NO#	FACIAL REFLECTOR BUCKET
20	1443590329	FAN MOUNT	81	NO#	LIGHT, DOUBLE FRAME
21	207	HEAD CUSION	82	4202	IGNITOR, 100-400W
22	F4W	LAMP, FACIAL - 100W - 400W	83	144359035	FACIAL BUCKET BRIDGE - MIDDLE
23		FACIAL BUCKET BRIDGE, BACK	84	144359021	HINGE ARM - RIGHT
31	1443269009	ACRYLIC HINGE, BENCH			
32		LAMP			
33	144282037	ACRYLIC CAM LOCK			
34	144307057	ACRYLIC CAM LOCK SCREW			
35	143252018	ACRYLIC RETAINING STRIP			
36		PROFILE FOR CHAULKING			
37	732BA	ACRYLIC SHIELD, BENCH			
38	143265013	LAMP BRIDGE, BENCH - FOOT			
39	144363017	REFLECTOR, BENCH - BACK			
50	143265006	REFLECTOR, BENCH - FRONT			
51	143266001	LEG END CAP, LEFT			
52	143266004	LEG, OUTER			
53	143266005	LEG, INNER			
54	143266006	LEG REINFORCEMENT PLATE			
55	143265018	BENCH SHELL			
56	144359022	HINGE ARM - LEFT			
57	143266012	FACADE, BACK			
58	143266013	FACADE, FRONT			
59	143265012	METAL DECK PLATE, BENCH			
60	143269003	METAL DECK PLATE, BENCH			
61	143262006	BENCH REFLECTOR SUPPORT			
62		AIR FLOW DIRECTOR			

Refer to illustration on previous page  
to visually identify the part you need  
to replace or repair.

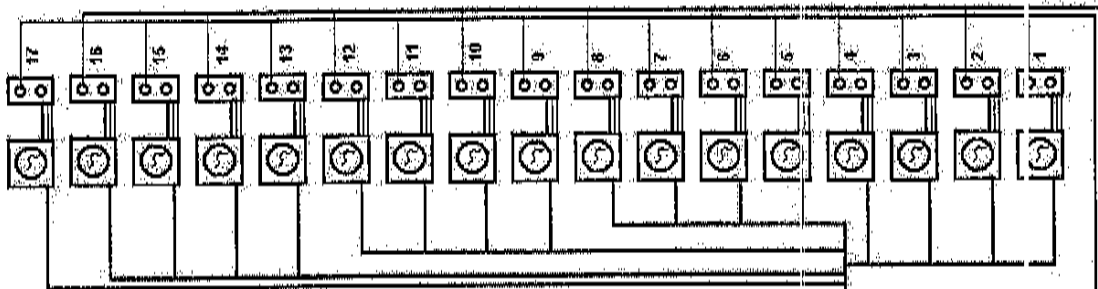

10/02/01  
**V1 COLOR**  
 PRB GG

735/3 BENCH  
 (+ switches)

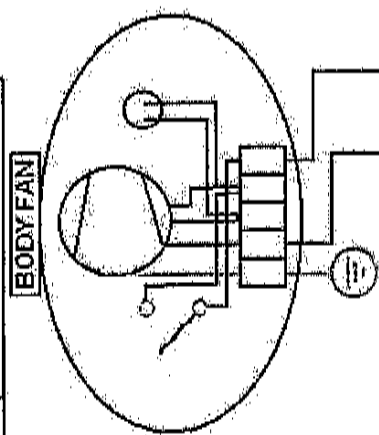

VENT FANS

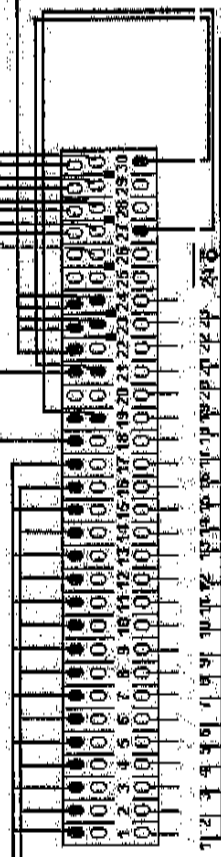

TO BALLAST TRAY

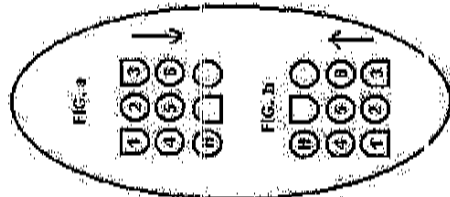
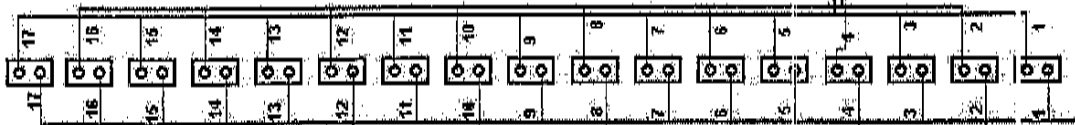
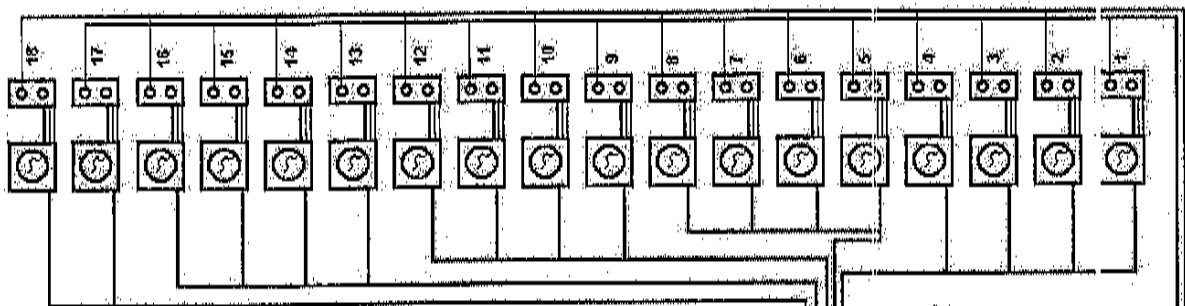
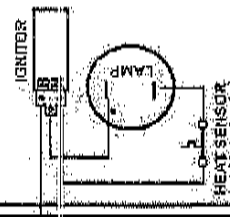
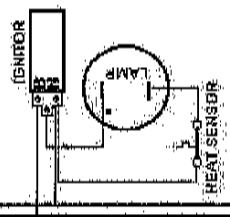
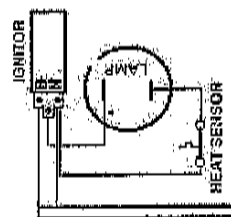
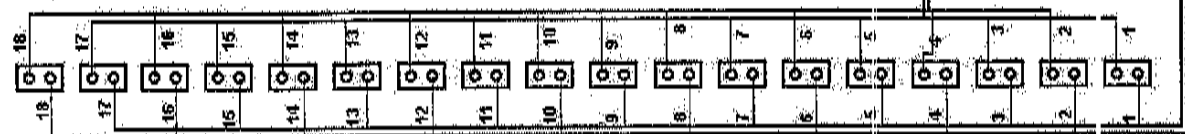
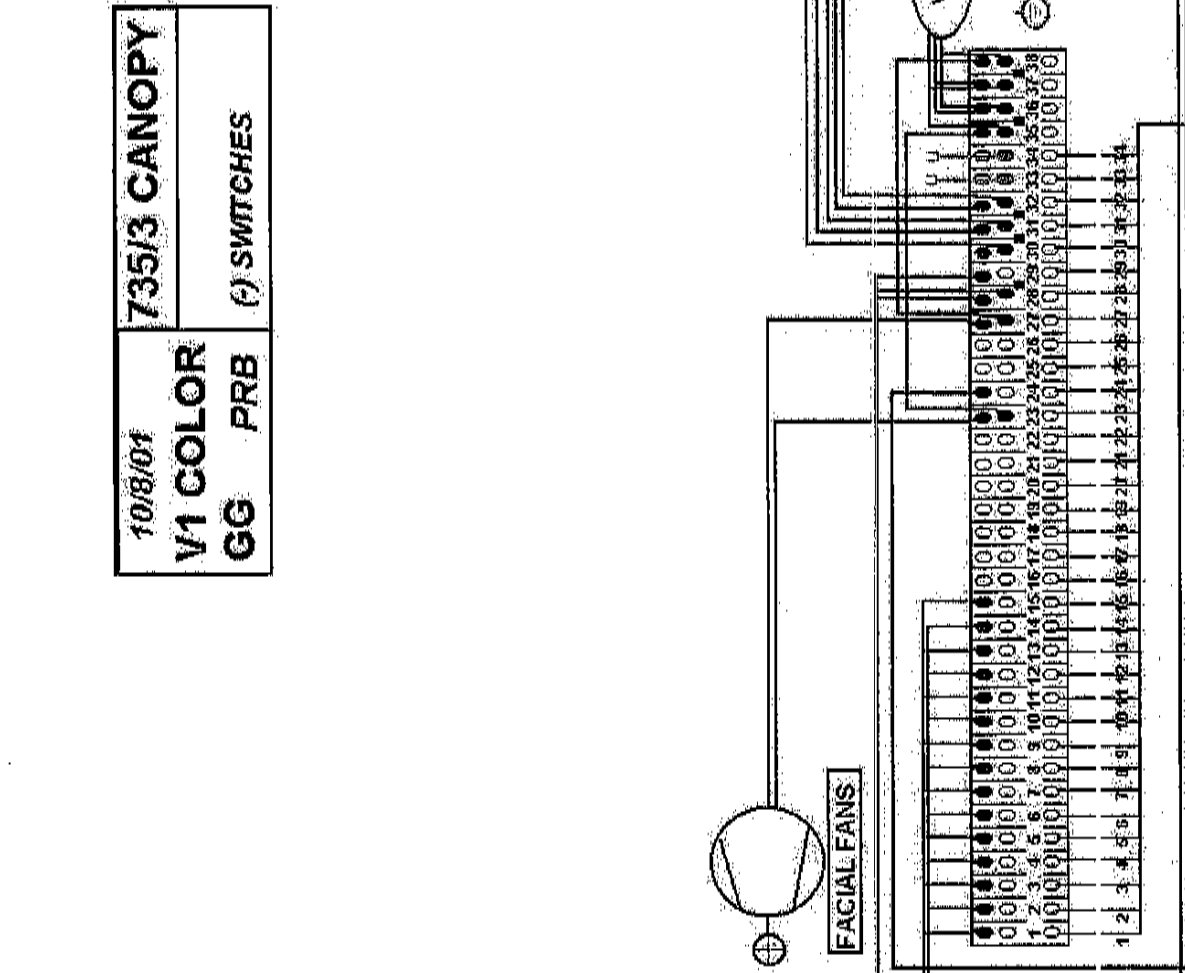

FIG. 9  
 FIG. 10



10/8/01  
 V1 COLOR  
 GG PRB  
 735/3 CANOPY  
 (P) SWITCHES







11/10/00 730/1 BENCH  
 V1 COLOR  
 GG PB

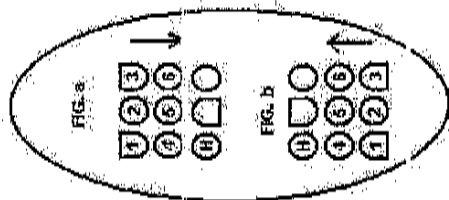
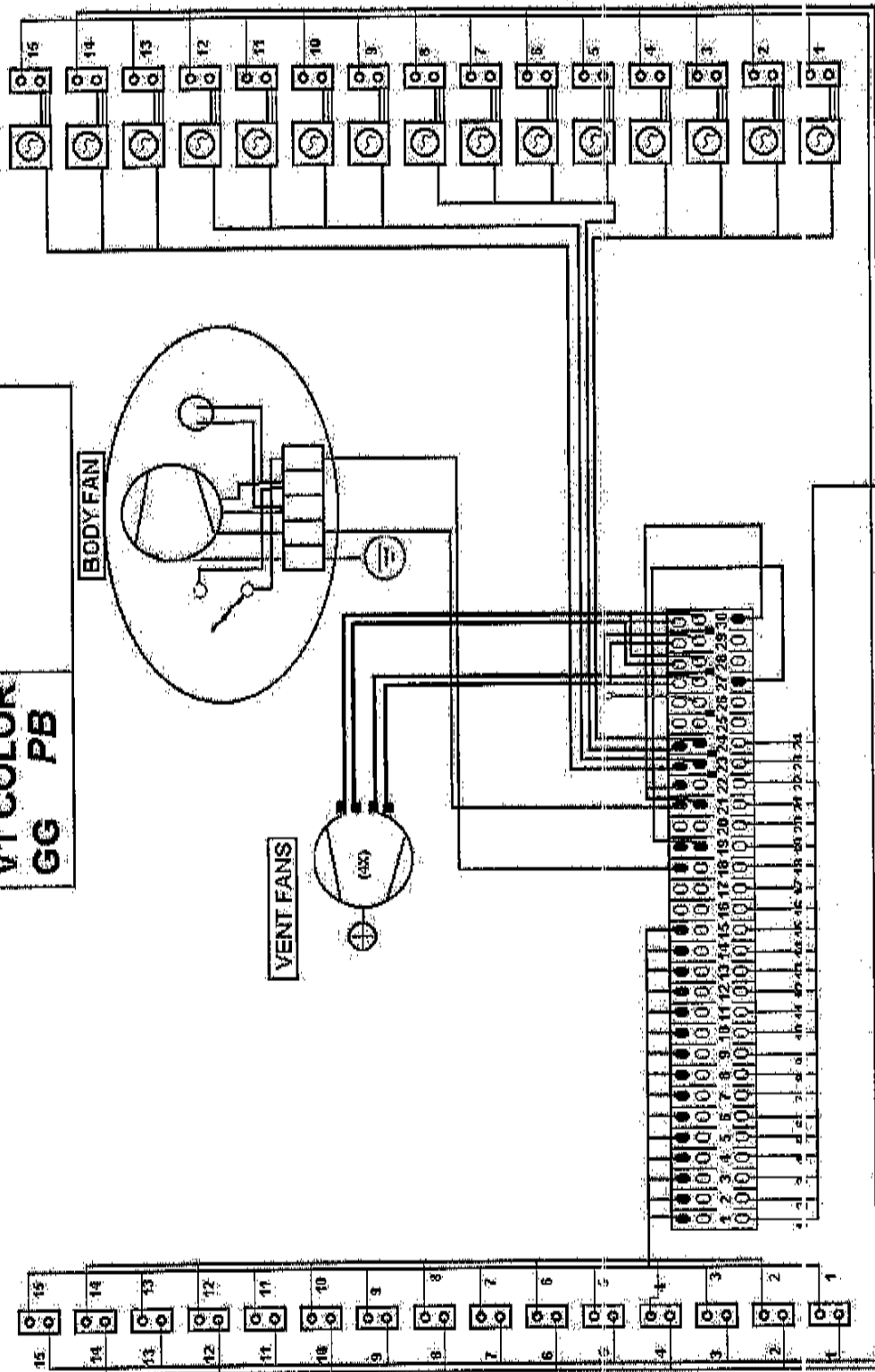

**11/10/00**  
**V1 COLOR**  
**GG PB**

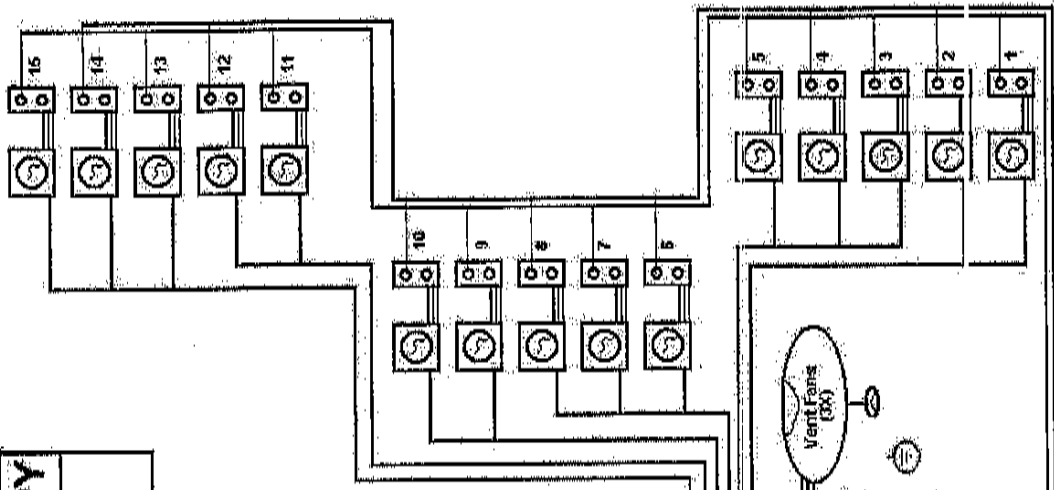

**FACIAL FAN**

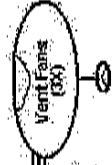

**TO BALLAST TRAY**

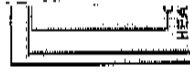
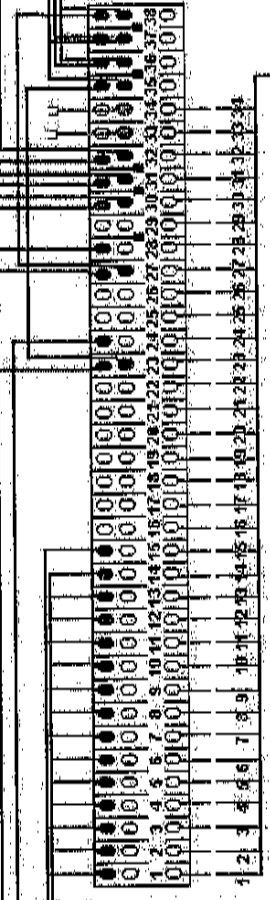

Model: 730/1  
By: PEB 3/15/01

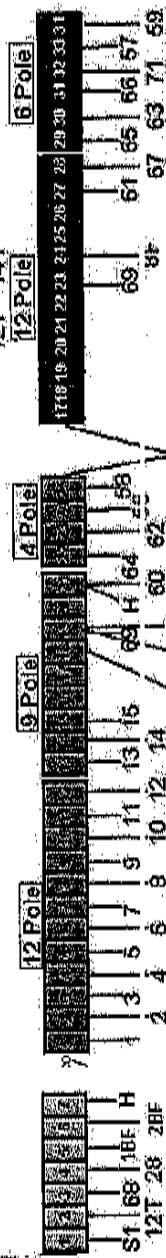
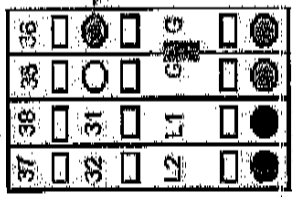
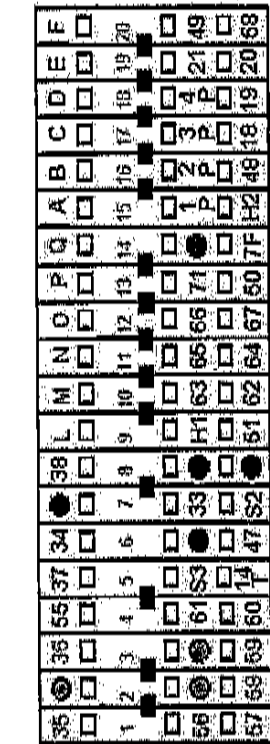
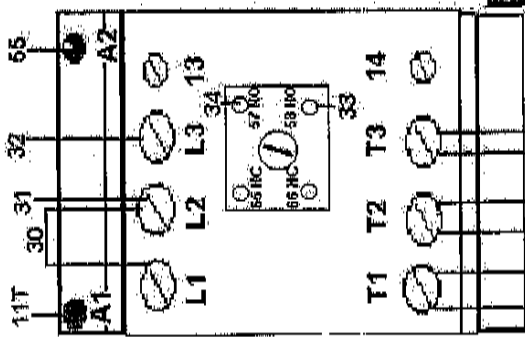
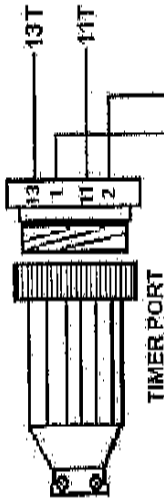
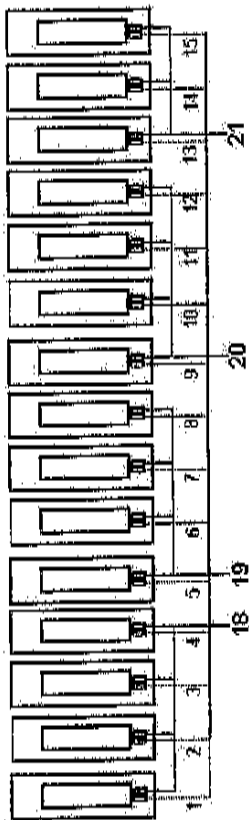
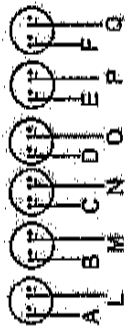

(POWER PLUG)

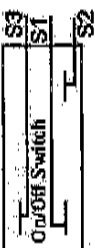
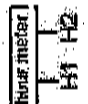

7 Holes

**BODYSCAN 3500/3 & KLASSIK SERIES • SonnenBräune, Inc.**

---

SonnenBräune, Inc.  
6362 Battlefield Parkway  
Ringgold, Georgia 30736 USA

800-829-6533 or 706-937-2005  
Fax 706-937-5609

email: [sales@sonnenbraune.com](mailto:sales@sonnenbraune.com)  
web: [www.sonnenbraune.com](http://www.sonnenbraune.com)

Ricky W. Gray, President  
Louise Gray, Vice President  
Jim L. Jones, Executive Sales Manager

For information about SonnenBräune's world wide distributor network and contacts, please see our web site on the distributor locator page.  
[www.sonnenbraune.com](http://www.sonnenbraune.com)