

24 LAMP '05  
RESIDENTIAL CANOPIES  
26960-01, REV A

LAMP HOLDERS WITH STARTERS  
(12 PLACES)

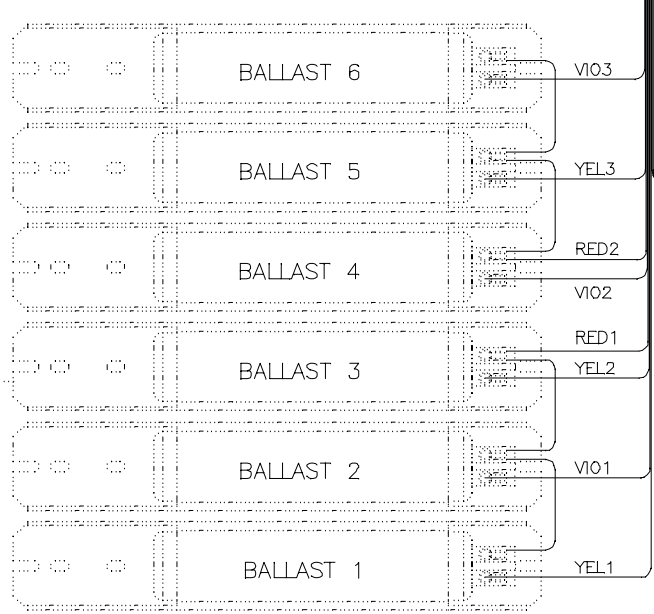
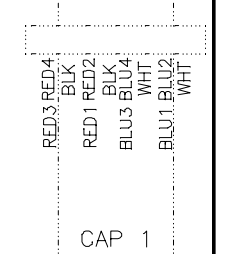
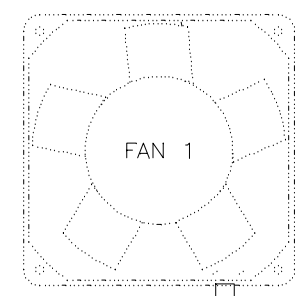
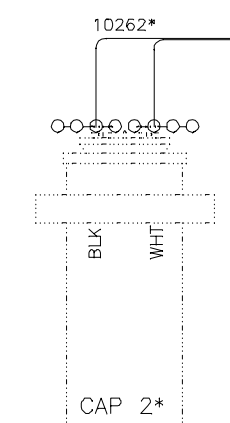
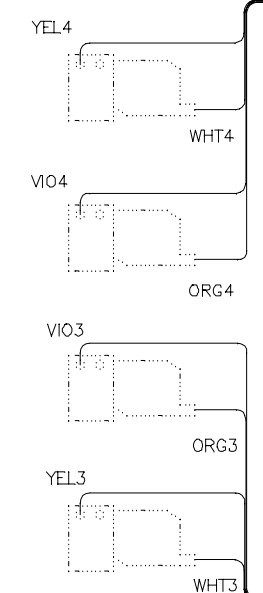
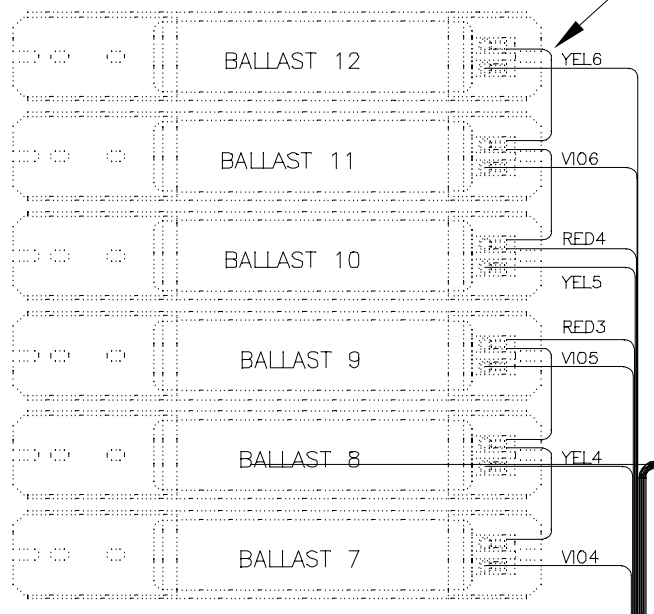

NOTES:  
1. PARTS MARKED WITH AN \*  
ARE USED ONLY ON THE  
FACE TANNER UNIT

TERMINAL BLOCK  
SWITCHED SIDE  
OF FANS

POWER IN → ← TO BENCH

RED 15105  
(8 PLACES)

BLU 15112  
(8 PLACES)

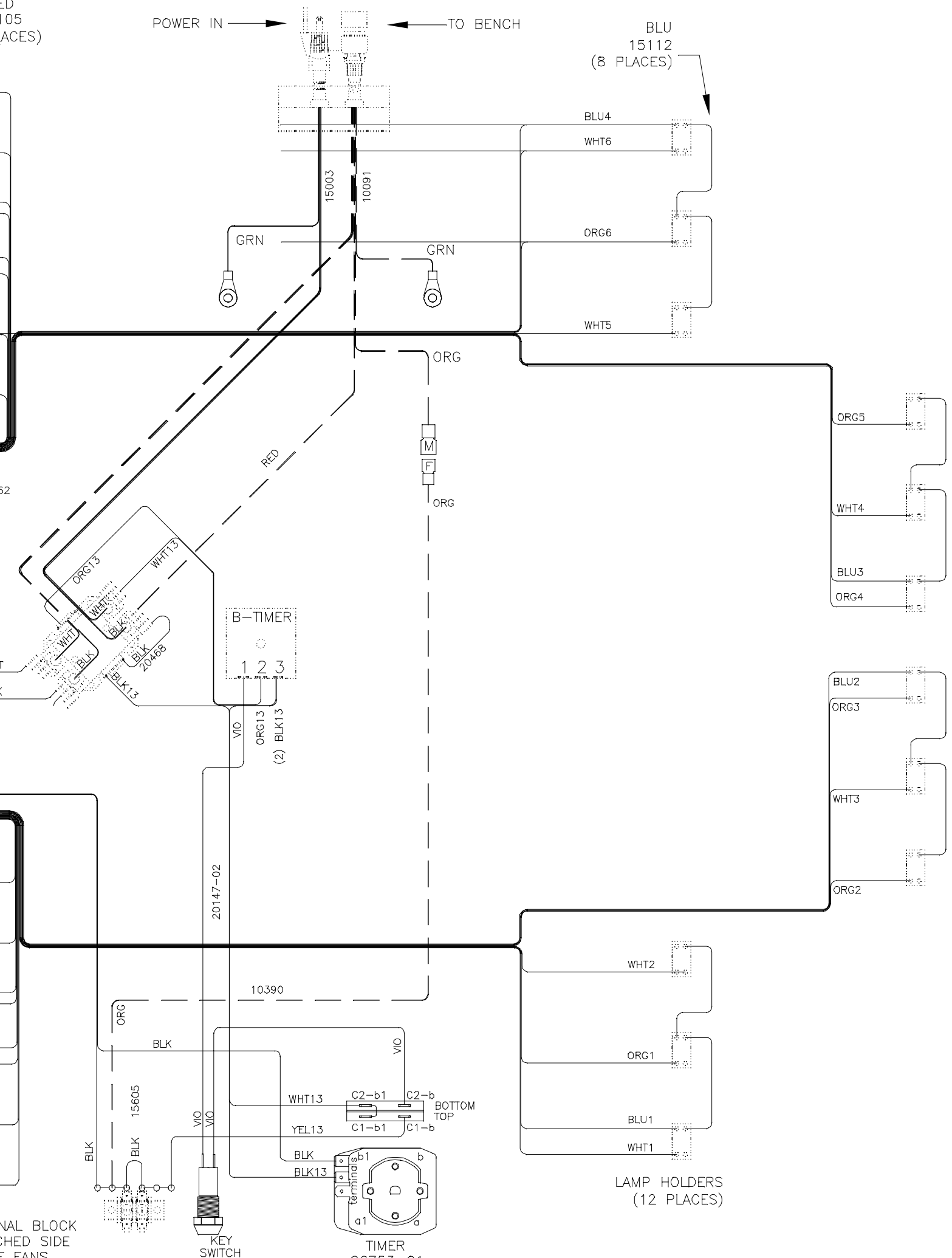

LAMP HOLDERS  
(12 PLACES)

26 LAMP '05  
RESIDENTIAL CANOPIES  
26960-01, REV A

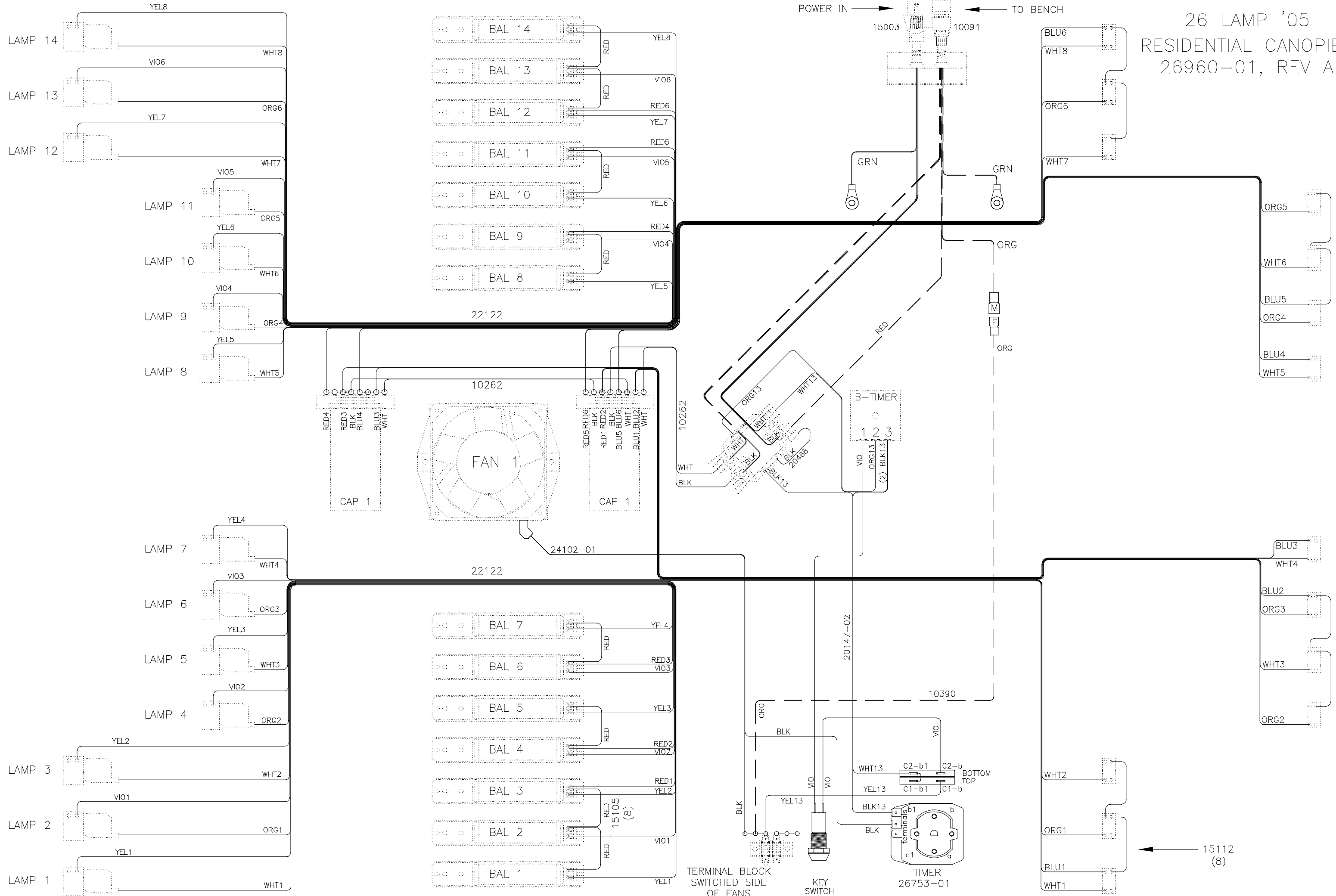

TERMINAL BLOCK  
SWITCHED SIDE  
OF FANS

KEY SWITCH

TIMER  
26753-01

15112  
(8)

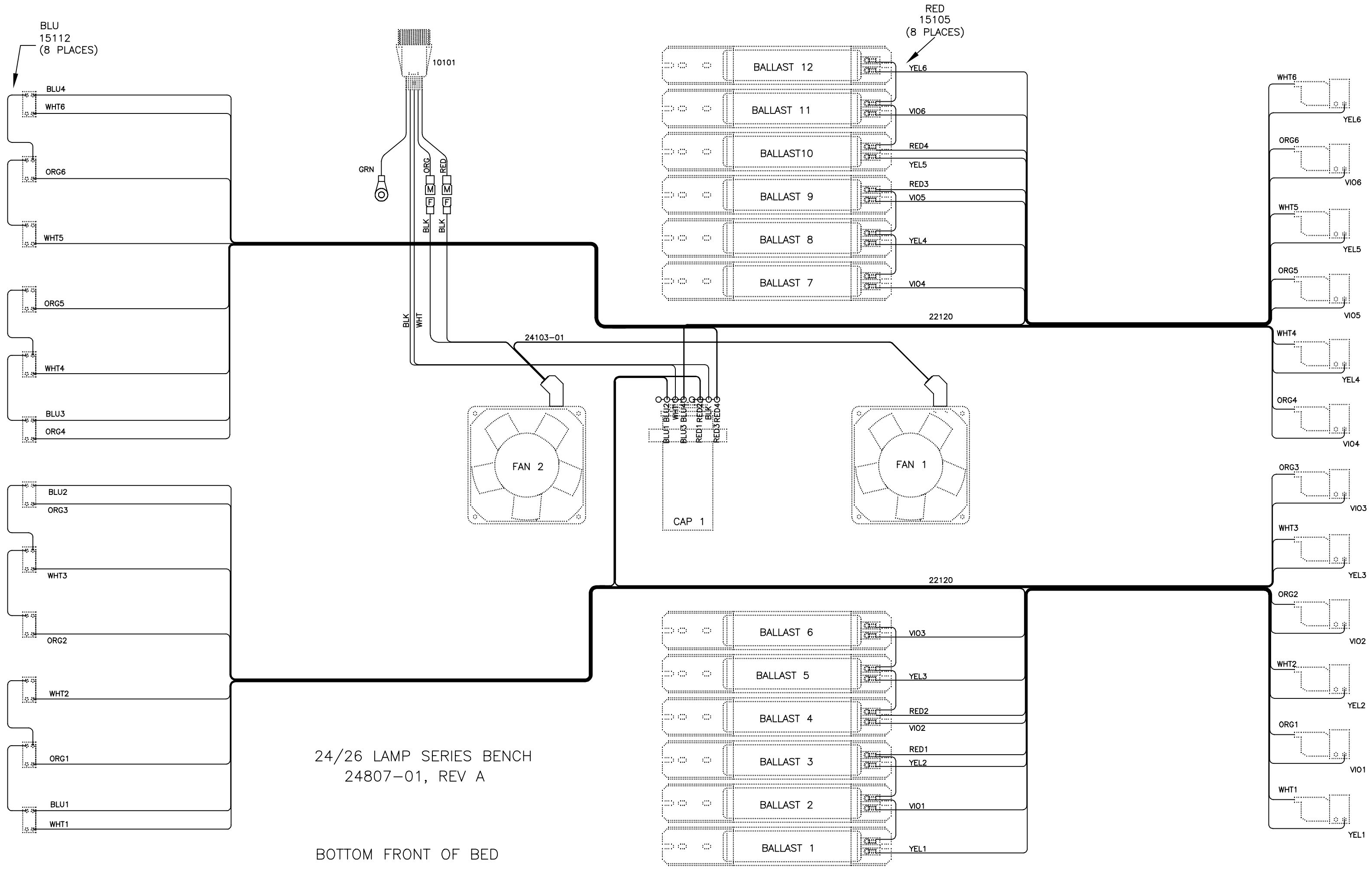

24/26 LAMP SERIES BENCH  
24807-01, REV A

BOTTOM FRONT OF BED