

POWER INPUT

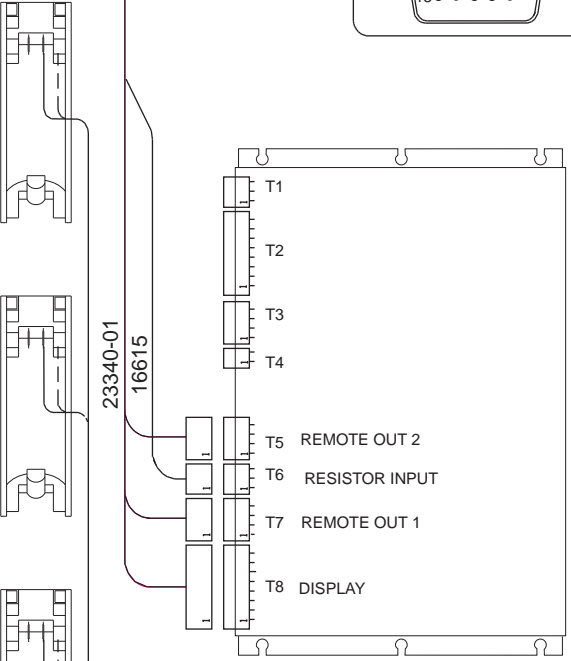

23517-01, REV. A
UPPER LEVEL TRAY, SOLARIS PLUS
WIRE DIAGRAM

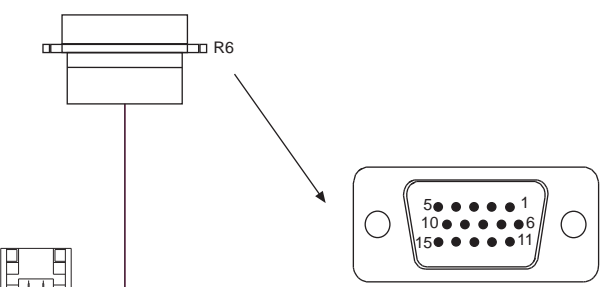
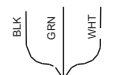
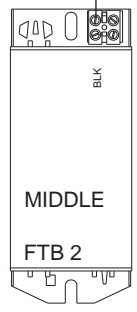
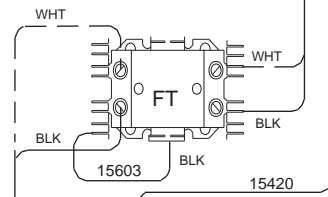
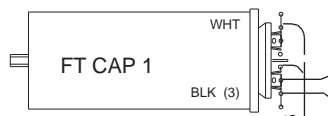
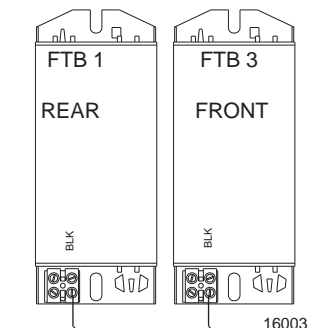

23345-01

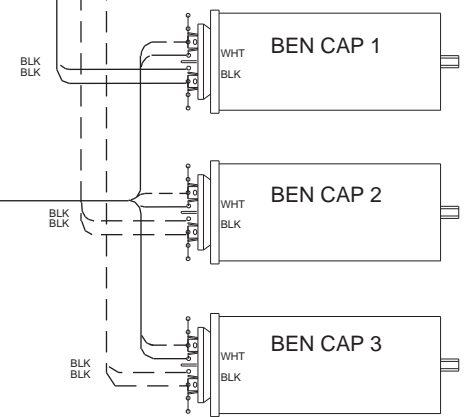
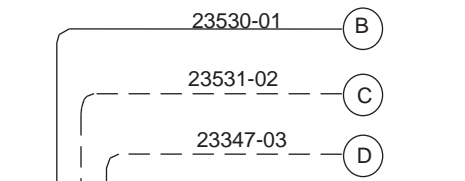
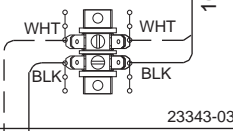
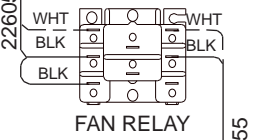
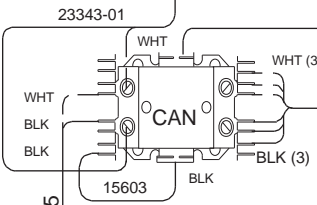
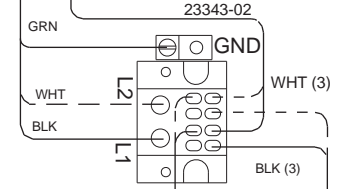
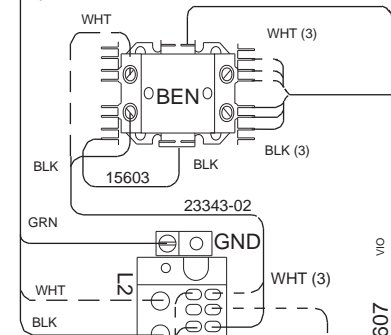

23342-01

23530-01 (B)
23531-02 (C)
23347-03 (D)

23346-01 (F)

P2
23198-01

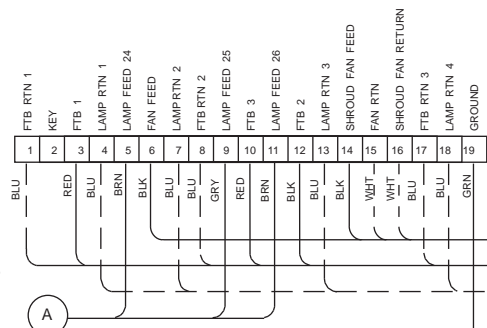

P4
23197-01

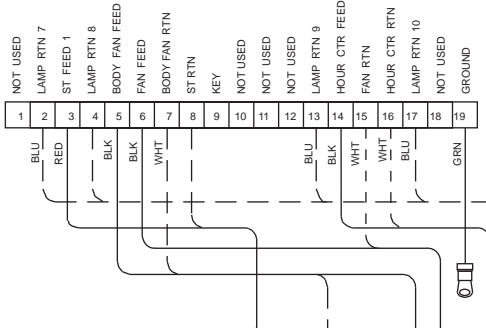

TO BALLAST
24 - 26

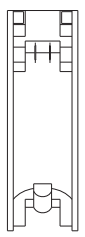
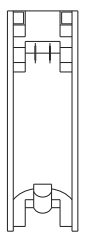
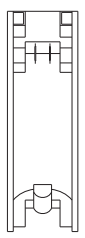

FRAME GROUND

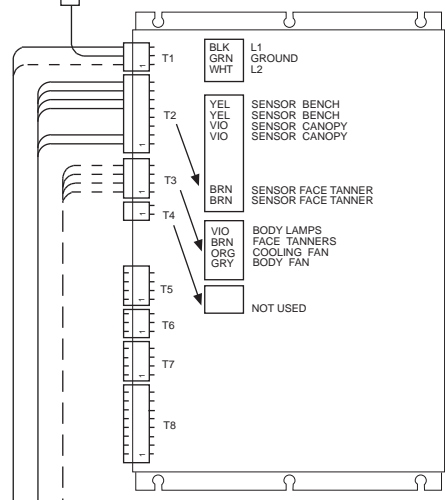

**23517-01, REV A
UPPER LEVEL TRAY
SOLARIS PLUS
WIRE DIAGRAM**

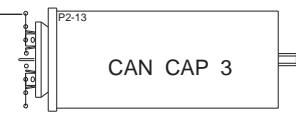
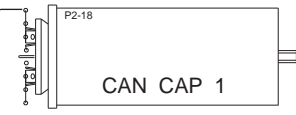
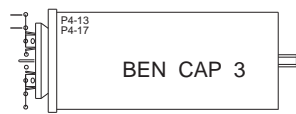
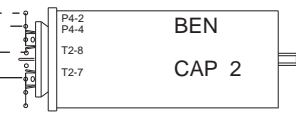
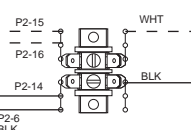
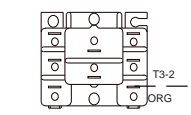
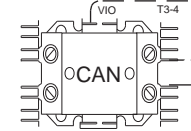
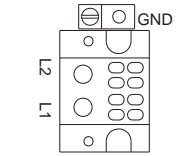
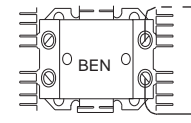
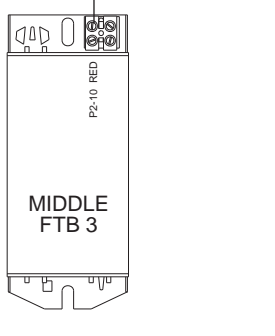
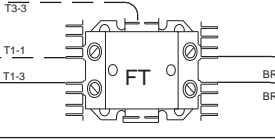
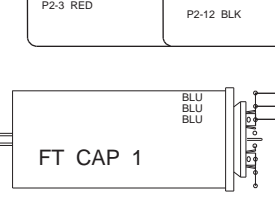
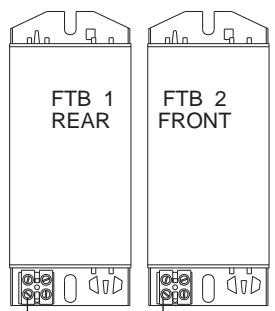

23516-01
23336-01

23335-01

WARNING: ALTERING THE DESIGN, TIMER SYSTEM OR WIRING FROM THAT SHOWN HEREIN, WILL VOID THE WARRANTY, AND MAY RESULT IN A VIOLATION OF FEDERAL LAW.

23196-01

P1



R1

23195-01

P3

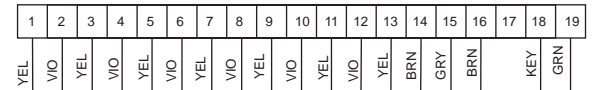

FRAME GROUND

TO R2

(A)

23198-01

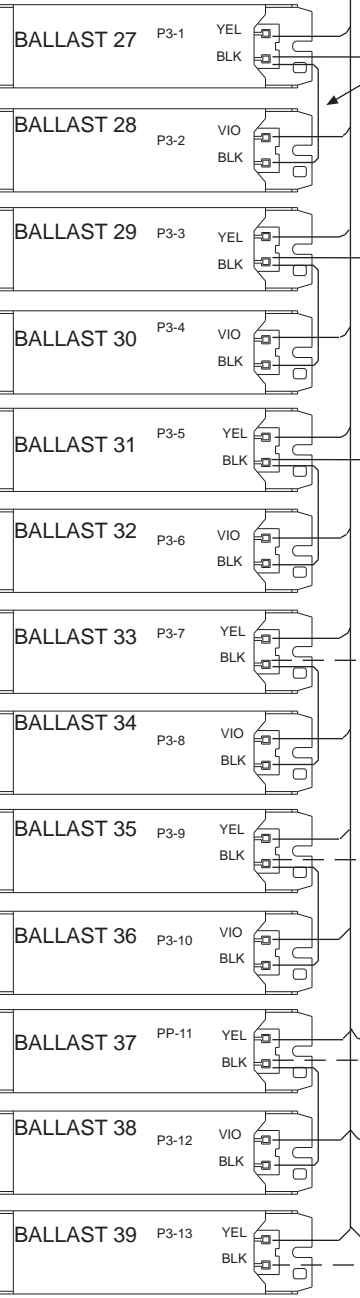
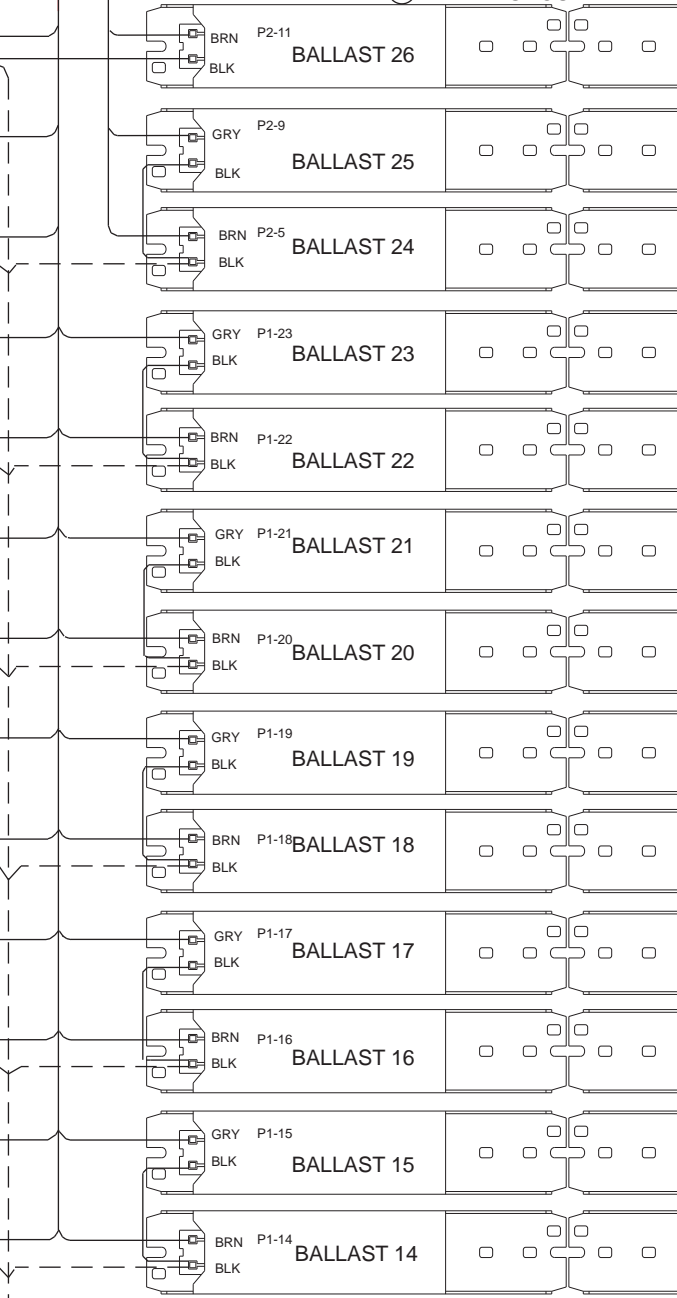
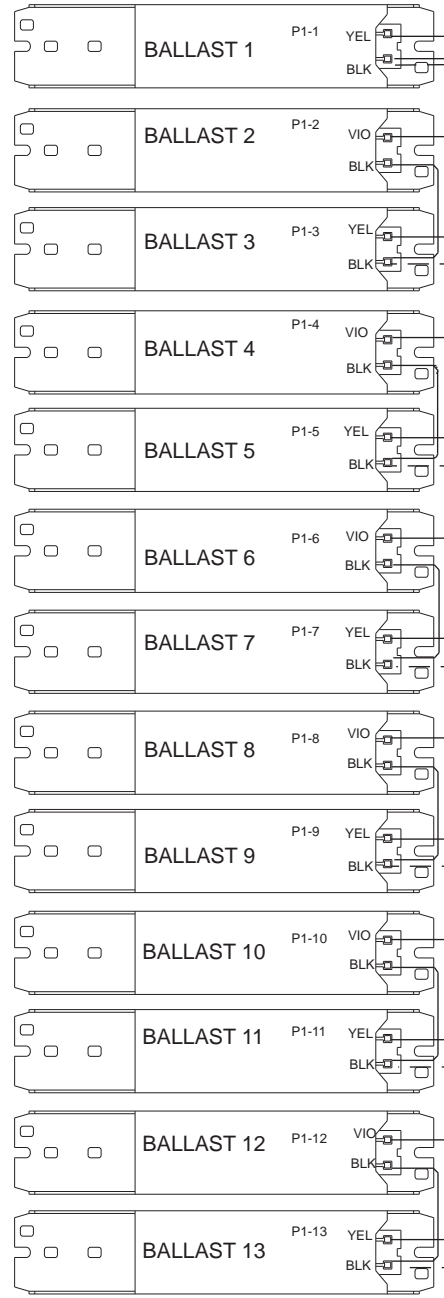

BLK 15905 (20 PLACES)

23530-01

(B)

23531-01

(C)

23347-03

(D)

TO BENCH CAPS

23518, REV A
SOLARIS PLUS TRAY BOTTOM
WIRE DIAGRAM

23346-01

(F)

TO CANOPY CAPS

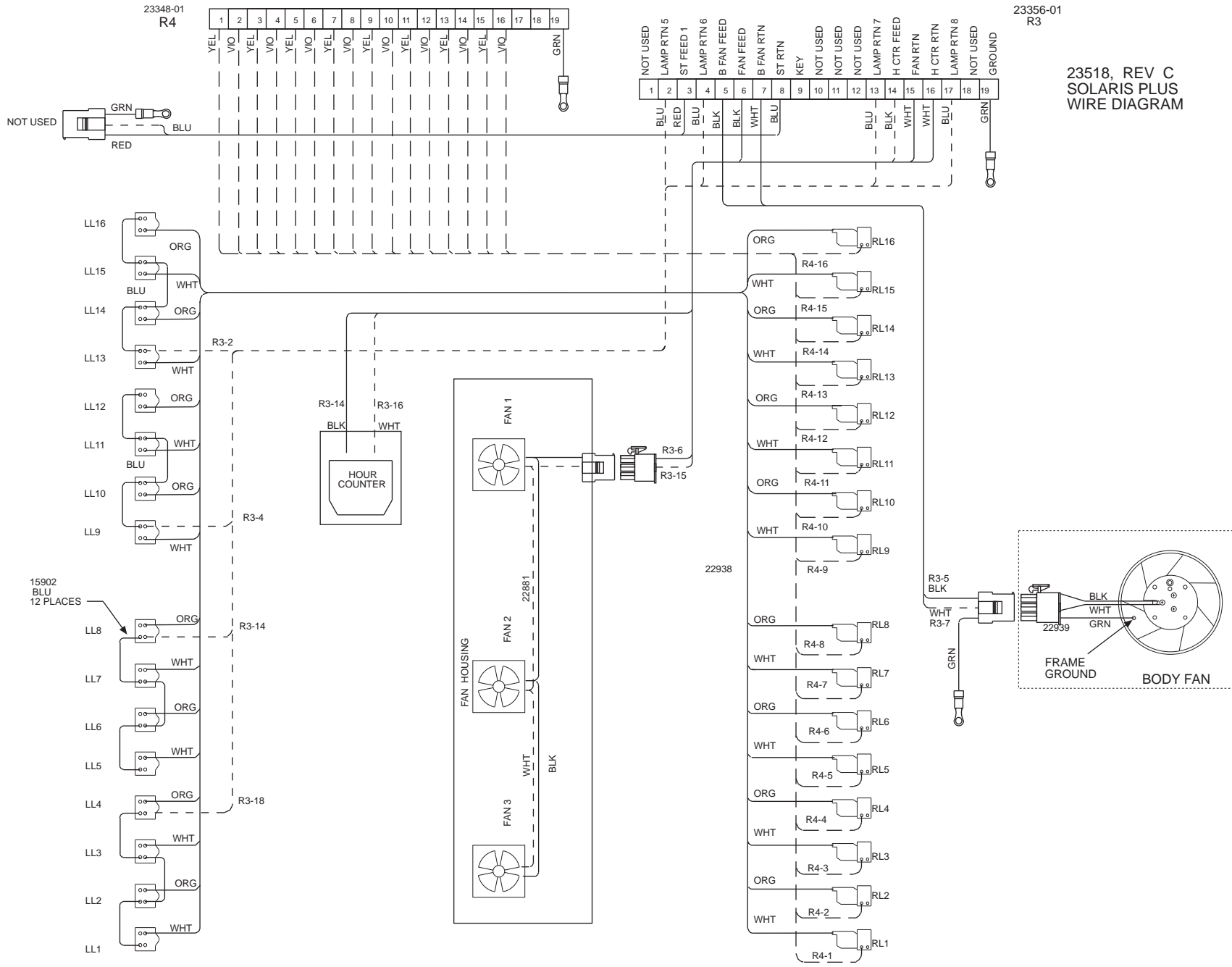

23518, REV C
SOLARIS PLUS
WIRE DIAGRAM

FRONT OF BED
(BOTTOM SIDE UP)

WARNING: ALTERING THE DESIGN, TIMER SYSTEM OR WIRING FROM THAT SHOWN HEREIN, WILL VOID THE WARRANTY, AND MAY RESULT IN A VIOLATION OF FEDERAL LAW.

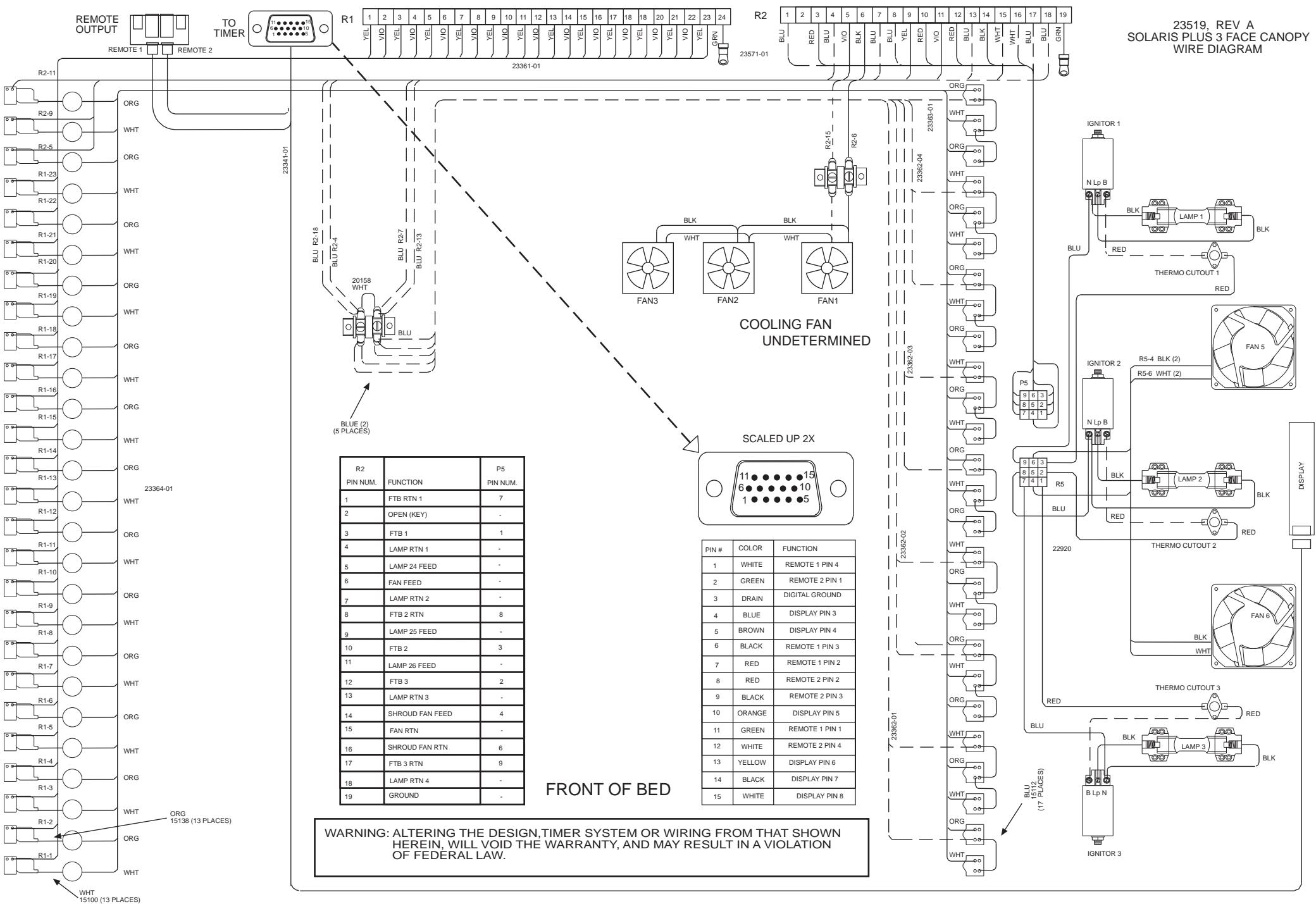

R2 PIN NUM.	FUNCTION	P5 PIN NUM.
1	FTB RTN 1	7
2	OPEN (KEY)	-
3	FTB 1	1
4	LAMP RTN 1	-
5	LAMP 24 FEED	-
6	FAN FEED	-
7	LAMP RTN 2	-
8	FTB 2 RTN	8
9	LAMP 25 FEED	-
10	FTB 2	3
11	LAMP 26 FEED	-
12	FTB 3	2
13	LAMP RTN 3	-
14	SHROUD FAN FEED	4
15	FAN RTN	-
16	SHROUD FAN RTN	6
17	FTB 3 RTN	9
18	LAMP RTN 4	-
19	GROUND	-

PIN #	COLOR	FUNCTION
1	WHITE	REMOTE 1 PIN 4
2	GREEN	REMOTE 2 PIN 1
3	DRAIN	DIGITAL GROUND
4	BLUE	DISPLAY PIN 3
5	BROWN	DISPLAY PIN 4
6	BLACK	REMOTE 1 PIN 3
7	RED	REMOTE 1 PIN 2
8	RED	REMOTE 2 PIN 2
9	BLACK	REMOTE 2 PIN 3
10	ORANGE	DISPLAY PIN 5
11	GREEN	REMOTE 1 PIN 1
12	WHITE	REMOTE 2 PIN 4
13	YELLOW	DISPLAY PIN 6
14	BLACK	DISPLAY PIN 7
15	WHITE	DISPLAY PIN 8

WARNING: ALTERING THE DESIGN, TIMER SYSTEM OR WIRING FROM THAT SHOWN HEREIN, WILL VOID THE WARRANTY, AND MAY RESULT IN A VIOLATION OF FEDERAL LAW.