

Uwe GmbH  
 Buchstrasse 82 · Postfach 2020  
 D-73510 Schwäbisch Gmünd



uwedeck3

drawing-no.	:	A7000/467	Z. - Nummer
device type/ designation	:	Typ 7019/100 HD Cayenne	Gerätetyp/ Anlagenbezeichnung
commission	:	USA	Kommission
path	:	3	Pfad
creation date	:	08.10.03	Erstelldatum
drawn by	:	NOS	Erstellt durch
modification date	:	25.07.07	Änderungsdatum
modified by	:	AKO	Geändert durch
power consumption	:	3/2~60Hz 220V 50/80A	Einspeisung
number of pages	:	57	Anzahl der Seiten

technical modifications reserved  
 Technische Änderungen vorbehalten

All rights reserved  
 Alle Rechte vorbehalten

0	1	2	3	4	5	6	7	8	9
	date 18.09.02	Typ 7019/100 HD	cover page				Zeichnungsnummer A7000/467		
	drawn NOS	Cayenne					drawing-no.		
2/3~	25.07.07	USA					ident. -no. :	CAD-Version: 5.60.3	page 1
modific. date	name norm	origin	repl. for 266596	repl. by			267225		57 pages

Uwe GmbH  
 Buchstrasse 82 · Postfach 2020  
 D-73510 Schwäbisch Gmünd



# index Inhaltsverzeichnis

UWE 20.12.2004

page Seiten-Nr.	page designation Seite	extra field	date Datum	drawer Zeichner	X
1	cover page		11. Feb. 2005	NOS	
2	index		17. Apr. 2007	NOS	x
3	index		17. Apr. 2007	NOS	x
4	index		17. Apr. 2007	NOS	x
5	lamps, identification		17. Apr. 2007	NOS	
6	mounting plate no1; control		17. Apr. 2007	NOS	
7	mounting plate no.1 control panel		17. Apr. 2007	NOS	
8	mounting plate no. 2		17. Apr. 2007	NOS	
9	mounting plate no. 3		17. Apr. 2007	NOS	
10	mounting plate no. 4		17. Apr. 2007	NOS	
11	mounting plate no. 5; base		17. Apr. 2007	NOS	
12	canopy		17. Apr. 2007	NOS	
13	bottom view base		17. Apr. 2007	NOS	
14	pedestral housing		17. Apr. 2007	NOS	
15	aroma module		17. Apr. 2007	NOS	
16	terminal block X52		11. Feb. 2005	NOS	
17	input terminal X52		11. Feb. 2005	NOS	
18	main circuit		17. Apr. 2007	MAD	
19	base lamps		17. Apr. 2007	MAD	
20	canopy lamps		28. Dez. 2006	MAD	
21	canopy lamps		10. Jan. 2007	NOS	
22	HP lamps		28. Dez. 2006	NOS	
23	light effects		15. Jan. 2007	NOS	
24	fan circuit		17. Apr. 2007	NOS	
25	PE		17. Apr. 2007	NOS	
26	breeze		17. Apr. 2007	MAD	
27	control circuit		17. Apr. 2007	MAD	
28	control circuit		17. Apr. 2007	NOS	
29	audio		17. Apr. 2007	NOS	

1

3

0		1		2		3		4		5		6		7		8		9	
		date		Typ 7019/100 HD	index														
		drawn	NOS	Cayenne															
2/3	25.07.07	checked	AKO	USA															
modific.	date	name	norm	origin	repl. for 266596	repl. by													

UWE GmbH  
 Buchstrasse 82 · Postfach 2020  
 D-73510 Schwäbisch Gmünd



Zeichnungsnummer  
 drawing-no. A7000/467

ident. -no. : CAD-Version: 5.60.3  
 267225

page 2  
 57 pages

# index Inhaltsverzeichnis

UWE 20.12.2004

page Seiten-Nr.	page designation Seite	extra field	date Datum	drawer Zeichner	X
30	modifications		17. Apr. 2007	MAD	
31	X1		17. Apr. 2007	AKO	
32	X2		17. Apr. 2007	AKO	
33	X3		17. Apr. 2007	AKO	
34	X4		17. Apr. 2007	AKO	
35	X5		17. Apr. 2007	AKO	
36	X6		17. Apr. 2007	AKO	
37	X7		17. Apr. 2007	AKO	
38	X8		17. Apr. 2007	AKO	
39	X9		17. Apr. 2007	AKO	
40	X10		17. Apr. 2007	AKO	
41	X12		17. Apr. 2007	AKO	
42	MP3+MP4		17. Apr. 2007	AKO	
43	X15		17. Apr. 2007	AKO	
44	X16		17. Apr. 2007	AKO	
45	X17		17. Apr. 2007	AKO	
46	X50		17. Apr. 2007	AKO	
47	X51		17. Apr. 2007	AKO	
48	X52		17. Apr. 2007	AKO	
49	X52		17. Apr. 2007	AKO	
50	X53		17. Apr. 2007	AKO	
51	X54		17. Apr. 2007	AKO	
52	X55		17. Apr. 2007	AKO	
53	X56		17. Apr. 2007	AKO	
54	X57		17. Apr. 2007	AKO	
55	X57		17. Apr. 2007	AKO	
56	X58		17. Apr. 2007	AKO	
57	X55a		17. Apr. 2007	AKO	
58	X80		17. Apr. 2007	AKO	

2

4

0	1	2	3	4	5	6	7	8	9
	date drawn checked	NOS AKO	Typ 7019/100 HD Cayenne USA	index			Zeichnungsnummer drawing-no. A7000/467		
2/3	25.07.07						ident. -no. : 267225	CAD-Version: 5.60.3	page 3 57 pages
modific.	date	name	norm	origin	repl. for 266596	repl. by			

UWE GmbH  
Buchstrasse 82 · Postfach 2020  
D-73510 Schwäbisch Gmünd



# index Inhaltsverzeichnis

UWE 20.12.2004

page Seiten-Nr.	page designation Seite	extra field	date Datum	drawer Zeichner	X
59	X10b		17. Apr. 2007	AKO	

3

5

0	1	2	3	4	5	6	7	8	9
		Typ 7019/100 HD Cayenne USA	index						
	date 25.07.07	drewn NOS	checked AKO	repl. for 266596	repl. by				
	date	name	norm	origin					

UWE GmbH  
Buchstrasse 82 · Postfach 2020  
D-73510 Schwäbisch Gmünd

Zeichnungsnummer  
drawing-no. A7000/467

ident. -no. : 267225

CAD-Version: 5.60.3

page 4  
57 pages

# lamps and identification

terminals:

connectors: X0 ... X29  
 terminal blocks: X50 ... X99  
 ext. components and subassembly: X100 ... X199

**component identification**

ballasts: L  
 ignition components: Z  
 lamps: E  
 control components: A  
 fans/motors: M  
 circuit-breaker: Q  
 control switch: S  
 timer: P

LP base lamps: E1-E20  
 HP and LP lamps canopy: E21-99

floorlight: E100

background light illumination: E101-E120

**color code**

color	code
white	WH
red	RD
blue	BU
green	GN
yellow	YE
grey	GY
brown	BN
orange	OG
black	BK
turquoise	TQ
ivory	IV
beige	BE
oliv	OL
violett	VI
green yellow	GNYE

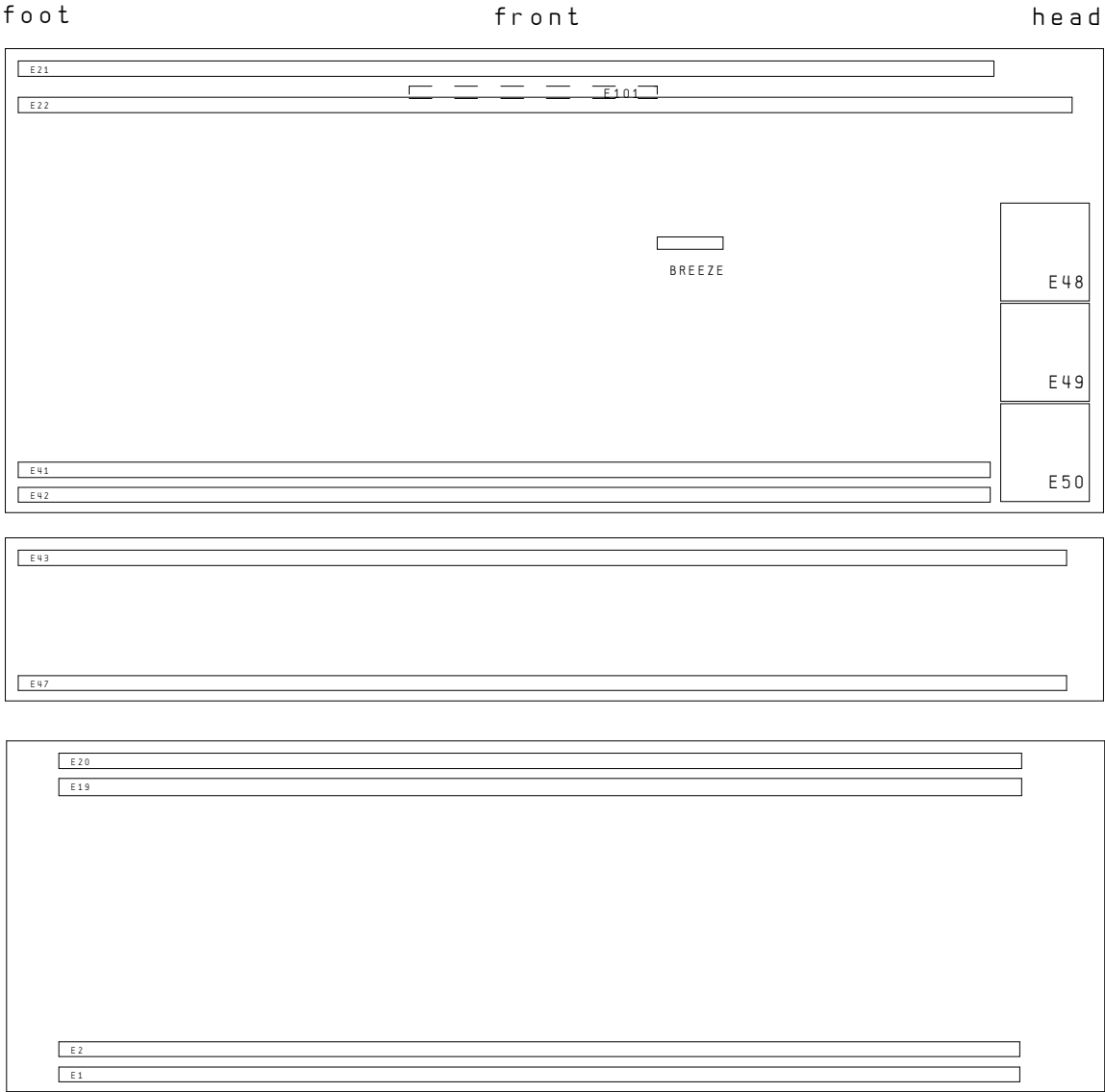

canopy

canopy

side  
tanner

base

front

6

0	1	2	3	4	5	6	7	8	9
	date	Typ 7019/100 HD	lamps, identification				Zeichnungsnummer	drawing-no.	A7000/467
	drawn	Cayenne						ident. -no. :	CARD-Version: 5.60.3
2/3	25.07.07	checked	USA				267225		5
modific.	date	name	norm	origin	repl. for 266596	repl. by			57 pages

mounting plate no. 1; control panel

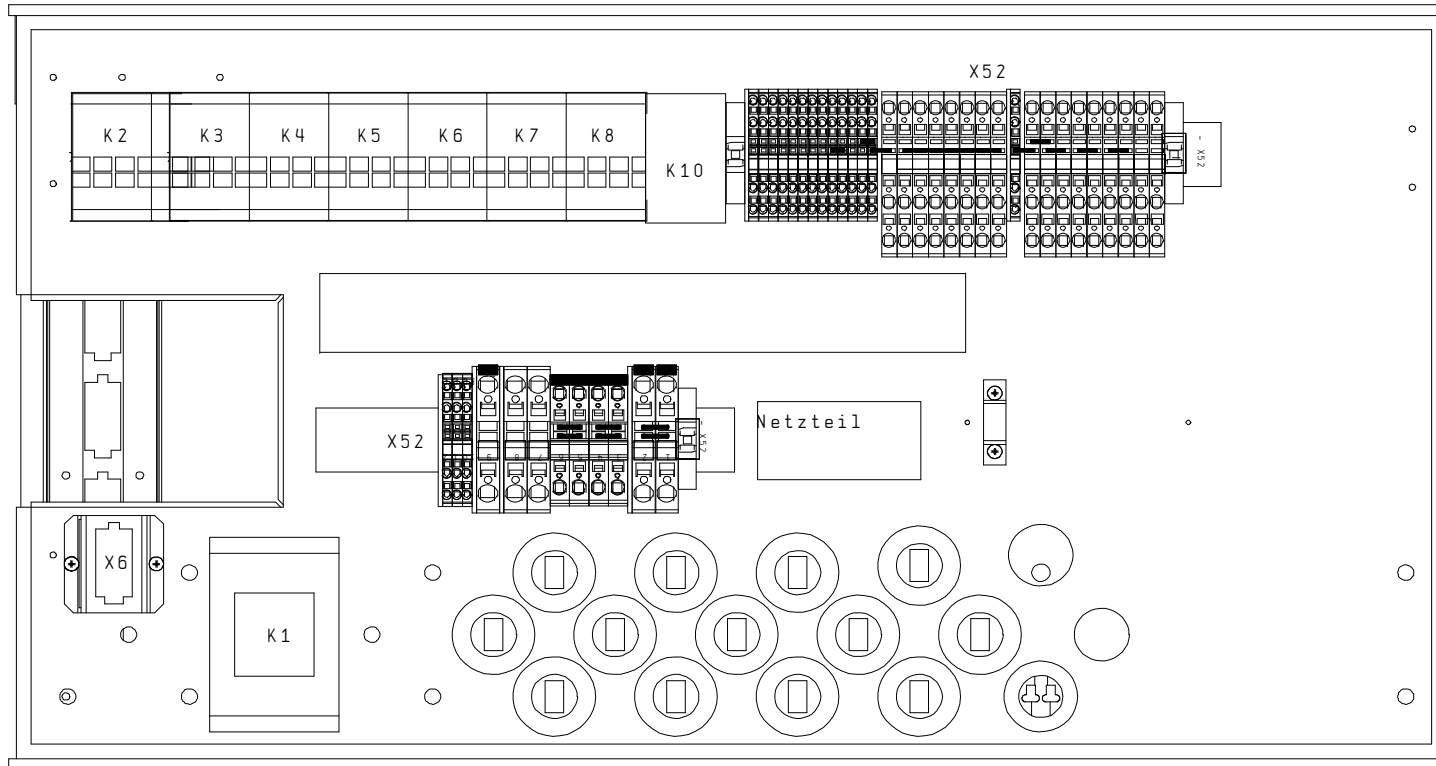

0		1		2		3		4		5		6		7		8		9	
		date		Typ 7019/100 HD		mounting plate no1;								Zeichnungsnummer					
		drawn		Cayenne		control								drawing-no.					
2/3~		25.07.07		USA										ident. -no. :		CAD-Version: 5.60.3		page	
modific.		date		origin		repl. for 266596		repl. by		Uwe GmbH		D-73510 Schwäbisch Gmünd		267225				6	
name		norm								UWE								57 pages	

mounting plate no. 1; control panel (back)

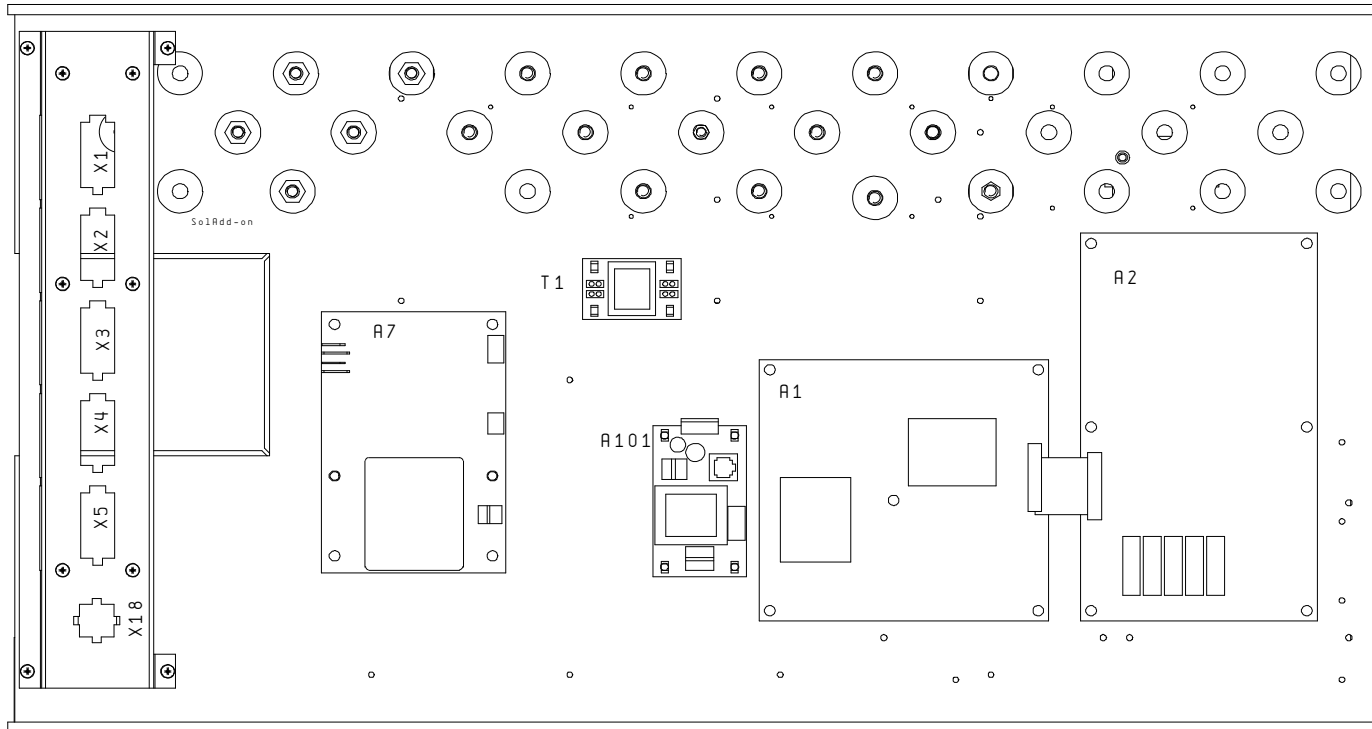

0	1	2	3	4	5	6	7	8	9
	date drawn checked	Typ 7019/100 HD Cayenne USA	mounting plate no.1 control panel				Zeichnungsnummer drawing-no. A7000/467		
2/3~	25.07.07	NOS AKO					ident. -no. : 267225	CRD-Version: 5.60.3	page 7
modific.	date	name	norm	origin	repl. for 266596	repl. by			57 pages



# mounting plate no. 2

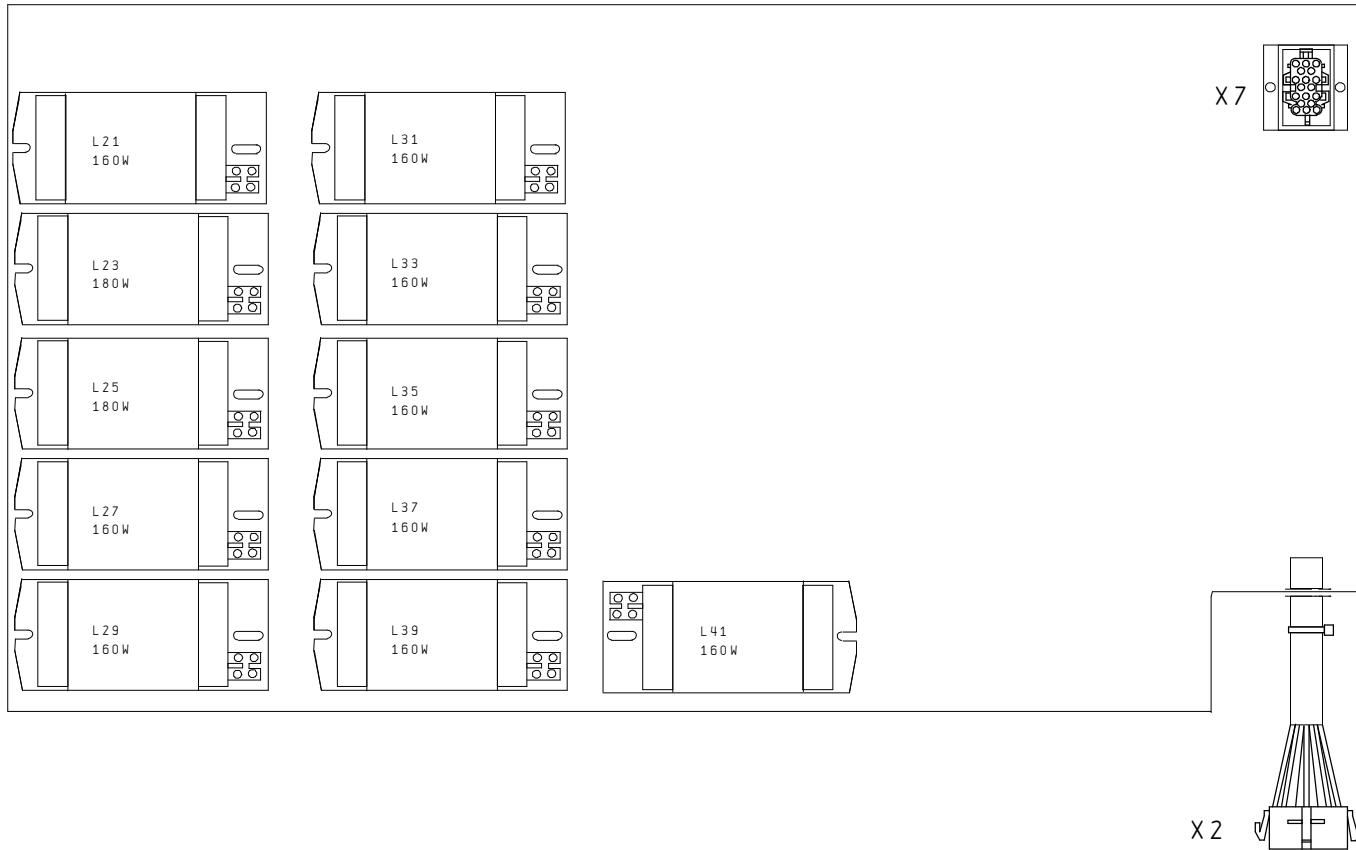

7

9

0	1	2	3	4	5	6	7	8	9
	date drawn checked	NOS RKD	Typ 7019/100 HD Cayenne USA	mounting plate no. 2		Uwe GmbH Buchstrasse 82 · Postfach 2020 D-73510 Schwäbisch Gmünd	Zeichnungsnummer drawing-no. A7000/467		
2/3~	25.07.07		repl. for 266596	repl. by		ident. -no. : 267225	CRD-Version: 5.60.3	page 8	57 pages



# mounting plate no. 3

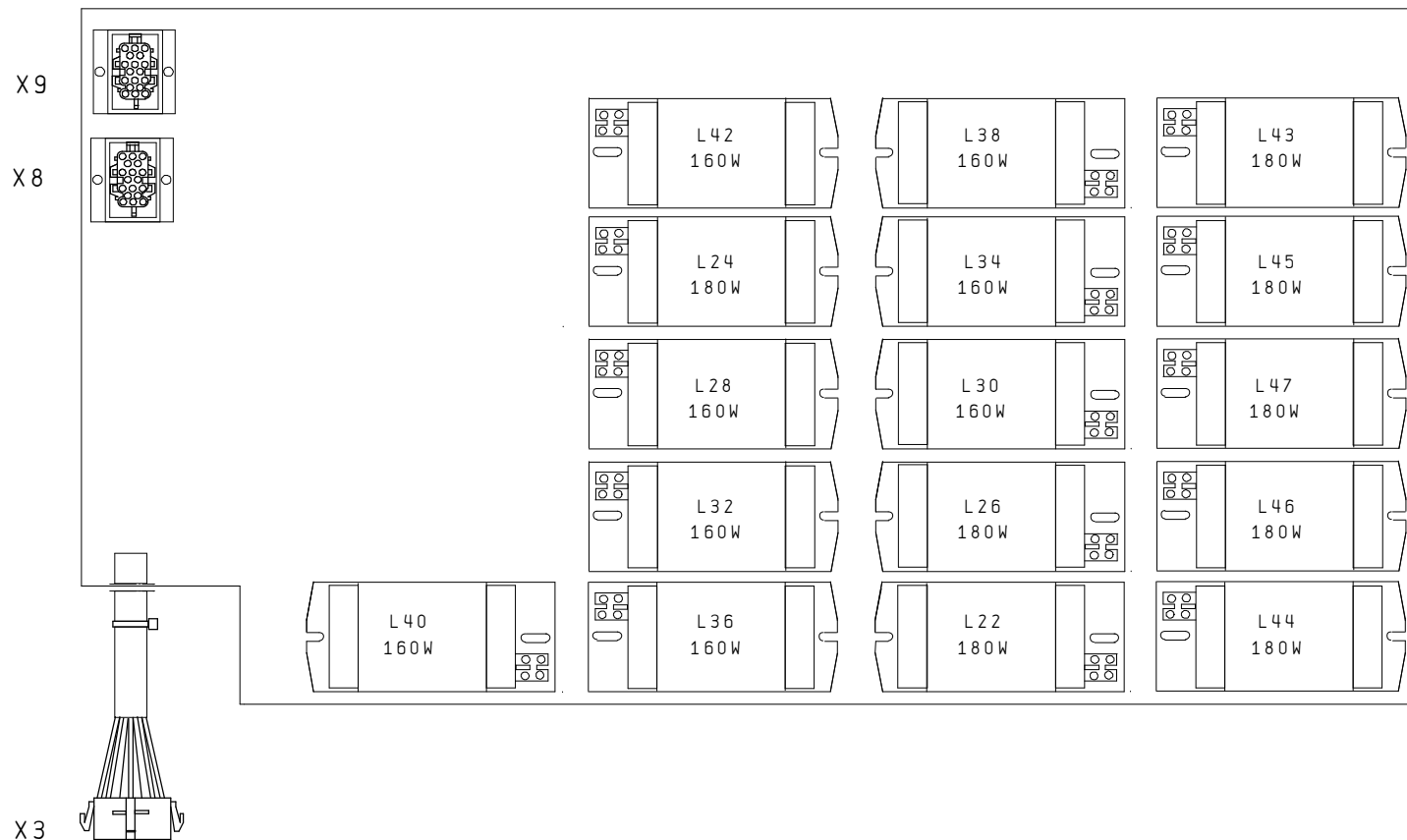

0	1	2	3	4	5	6	7	8	9
	date drawn checked	NOS RKD	Typ 7019/100 HD Cayenne USA	mounting plate no. 3	UWE GmbH Buchstrasse 82 · Postfach 2020 D-73510 Schwäbisch Gmünd		Zeichnungsnummer drawing-no. A7000/467	ident. -no. : 267225	CAD-Version: 5.60.3 page 9 57 pages
2/3~	25.07.07		origin	repl. for 266596	repl. by	UWE			

# mounting plate no. 4

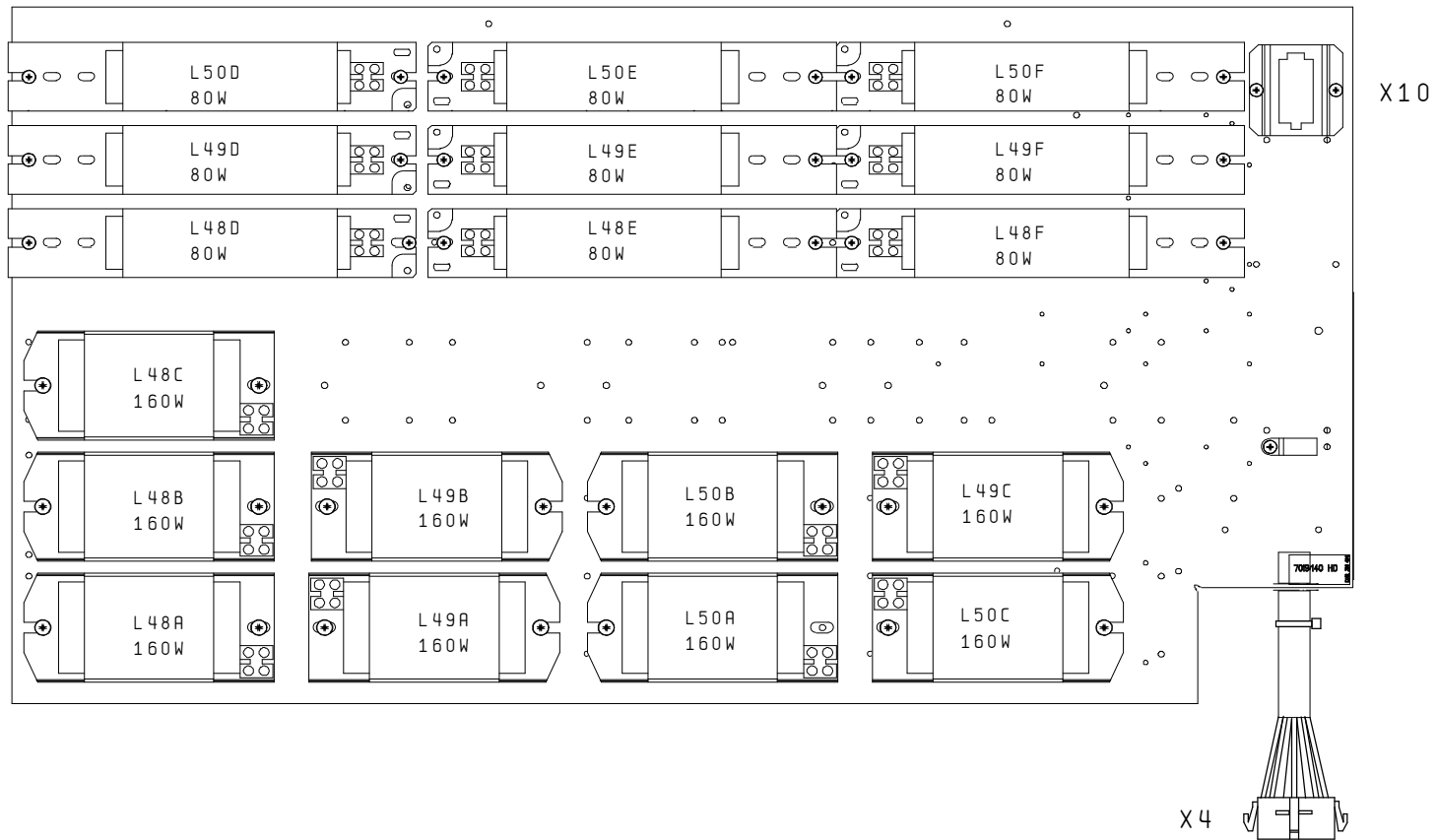

0		1		2		3		4		5		6		7		8		9	
		date		Typ 7019/100 HD		mounting plate								Zeichnungsnummer					
		drawn		Cayenne		no. 4				Uwe GmbH				drawing-no.		A7000/467			
2/3		25.07.07		USA						Buchstrasse 82 · Postfach 2020				ident. -no. :		CAD-Version: 5.60.3		page 10	
modific.		date		origin		repl. for 266596		repl. by		D-73510 Schwäbisch Gmünd		UWE		267225				57 pages	
		name		norm															

# mounting plate no. 5

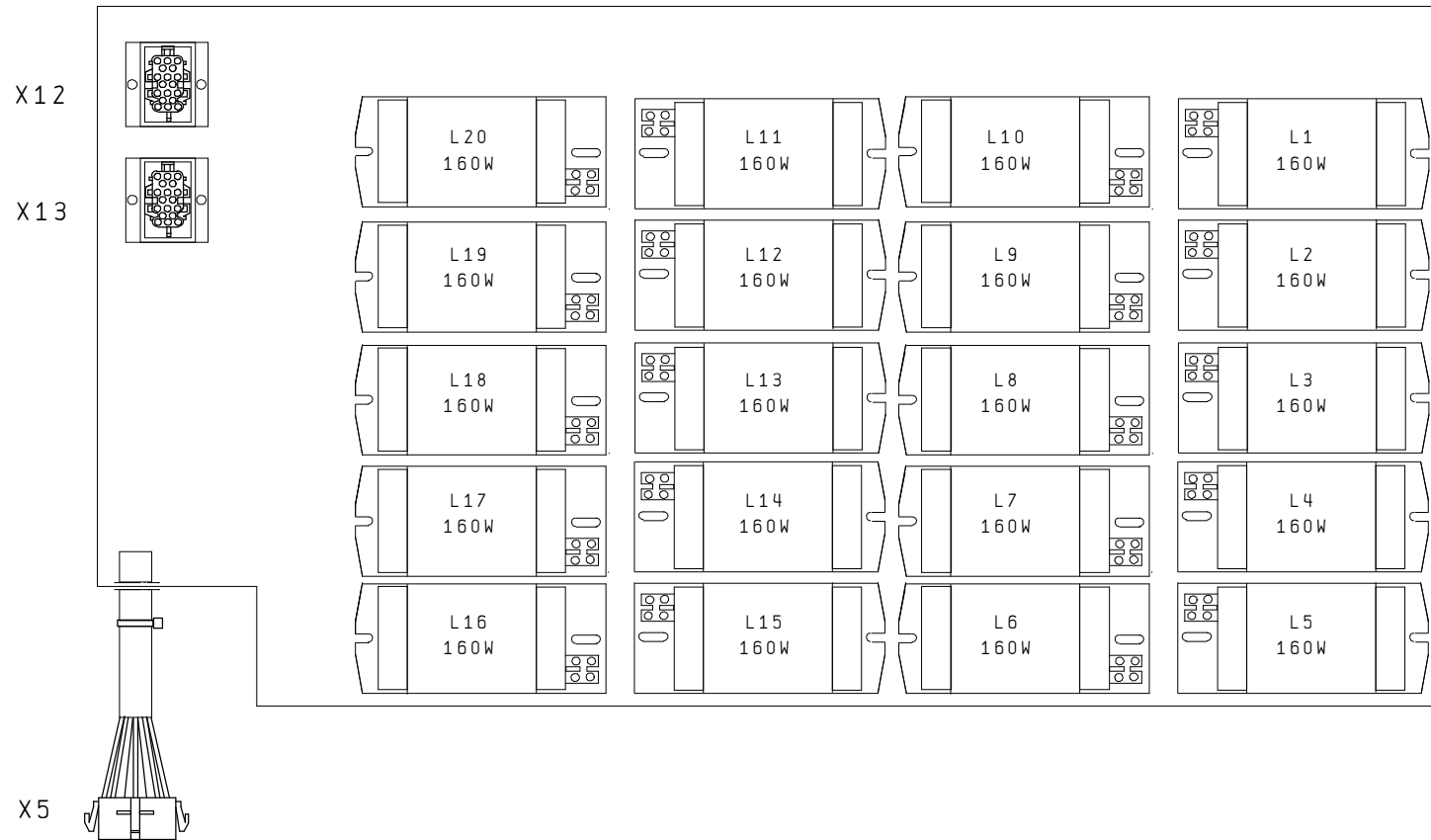

10

12

0		1		2		3		4		5		6		7		8		9	
		date		Typ 7019/100 HD	mounting plate									Zeichnungsnummer					
		drawn	NOS	Cayenne	no. 5; base									drawing-no.	A7000/467				
		checked	AKO	USA										ident. -no. :		CRD-Version: 5.60.3	page	11	
2/3~	25.07.07					repl. for 266596	repl. by							267225				57	pages

# canopy

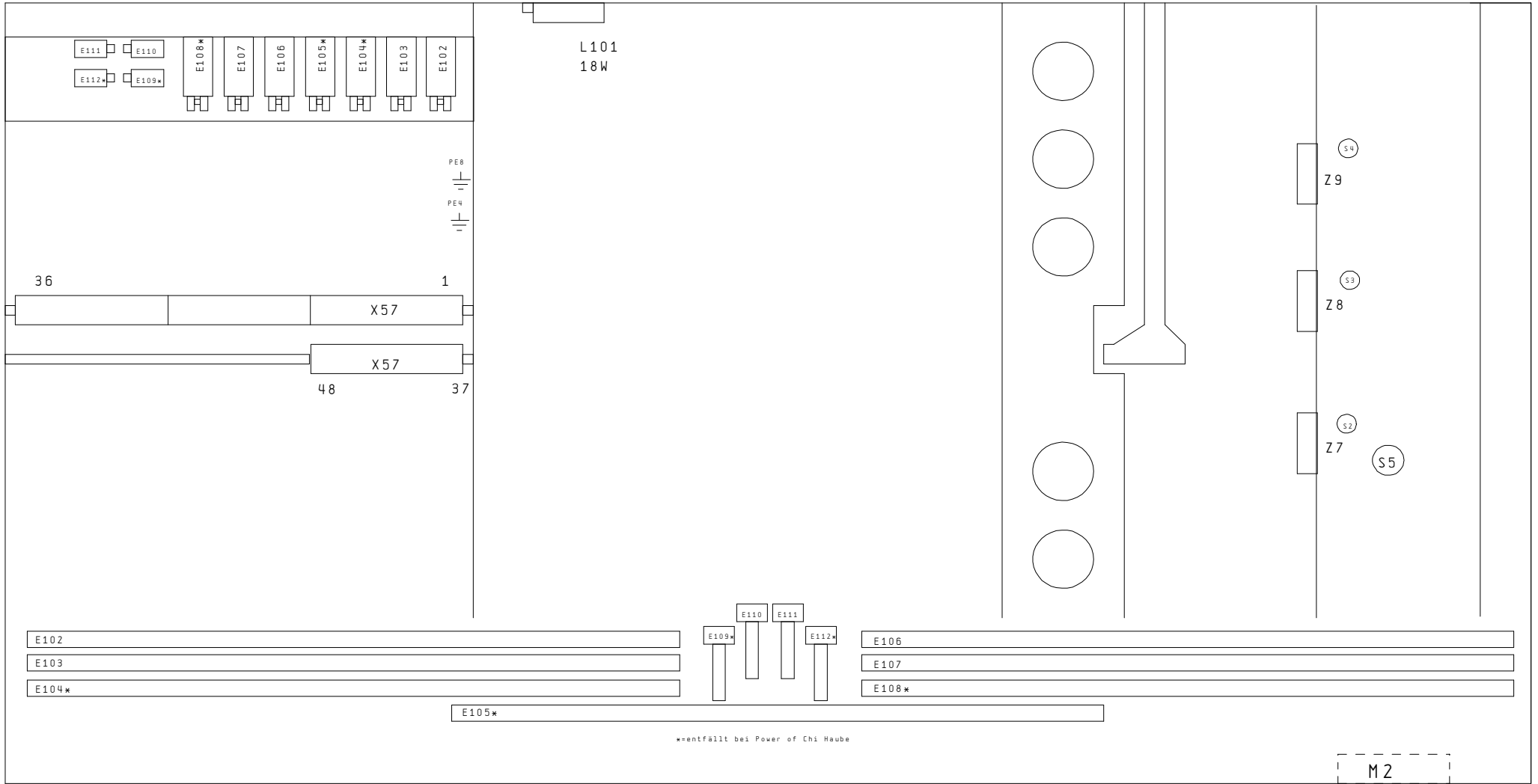

0	1	2	3	4	5	6	7	8	9
	date drawn NOS	Typ 7019/100 HD Cayenne	canopy				Zeichnungsnummer drawing-no. A7000/467		
Z/3~	25.07.07	checked AKO	USA				ident. -no. : 267225	CAD-Version: 5.60.3	page 12
modific. date	name	norm	origin	repl. for 266596	repl. by				57 pages

uwe GmbH  
Buchstrasse 82 · Postfach 2020  
D-73510 Schwäbisch Gmünd



# bottom view base

X12 X13

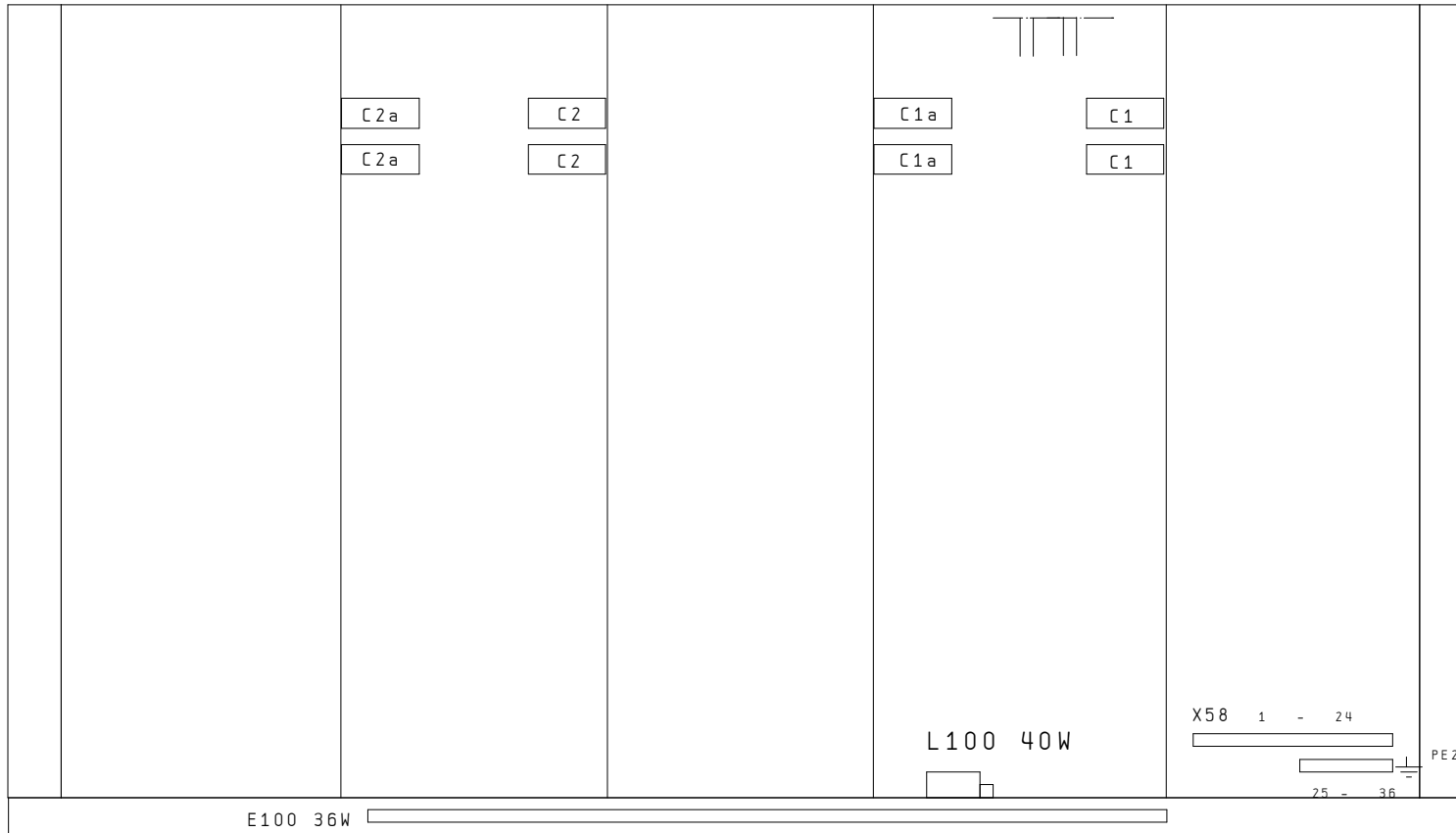
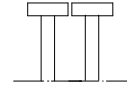

0	1	2	3	4	5	6	7	8	9
	date	Typ 7019/100 HD	bottom view base				Zeichnungsnummer	A7000/467	
	drawn	NOS	Cayenne				drawing-no.		
2/3	25.07.07	checked	AKO	USA			ident. -no. :	CRD-Version: 5.60.3	page 13
modific.	date	name	norm	origin	repl. for 266596	repl. by	267225		57 pages

Uwe GmbH  
 Buchstrasse 82 · Postfach 2020  
 D-73510 Schwäbisch Gmünd



# pedestal housing

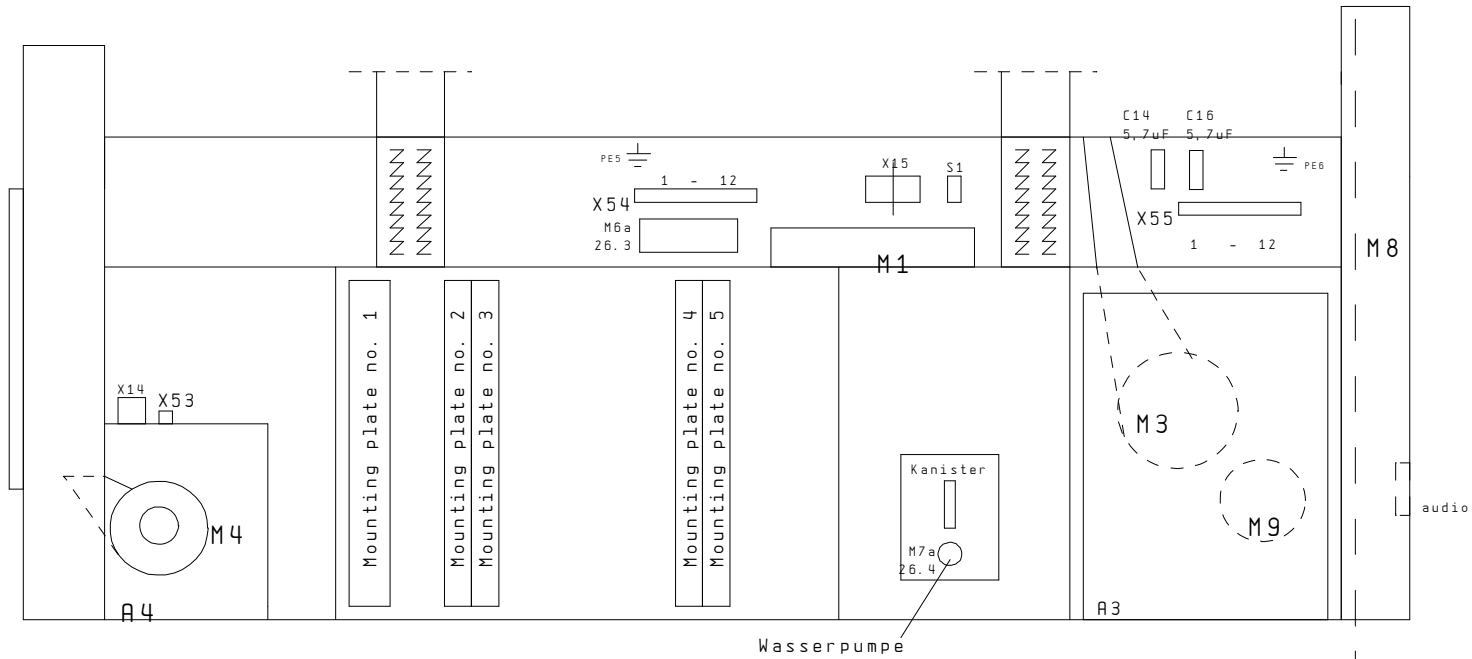
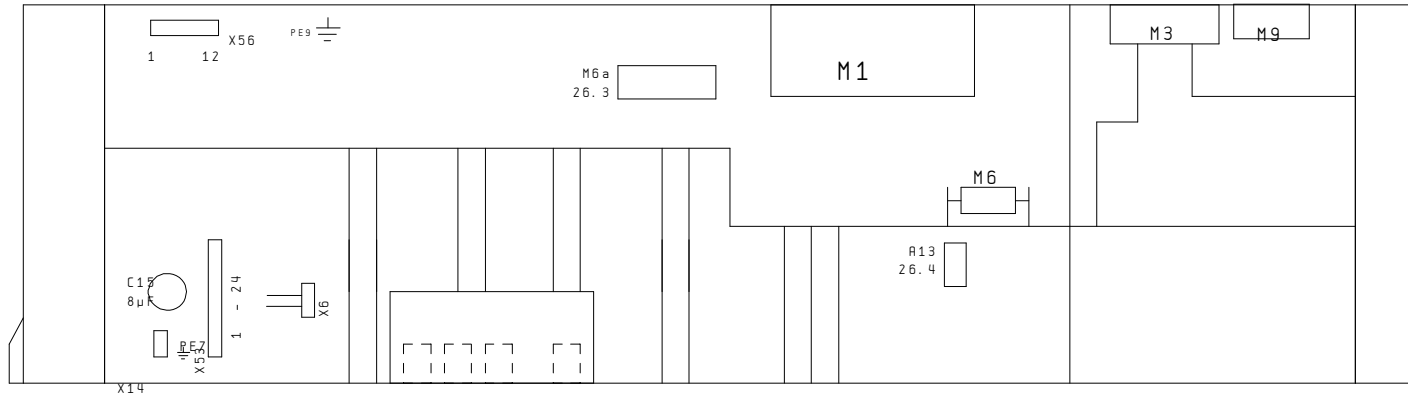

13

15

0	1	2	3	4	5	6	7	8	9
	date	Typ 7019/100 HD	pedestal housing				Zeichnungsnummer	A7000/467	
	drawn	NOS					drawing-no.		
2/3	25.07.07	checked	AKO	USA			ident.-no.:	CRD-Version: 5.60.3	page 14
modific.	date	name	norm	origin	repl. for 266596	repl. by	267225		57 pages

UWE GmbH  
 Buchstrasse 82 · Postfach 2020  
 D-73510 Schwäbisch Gmünd



# aroma module

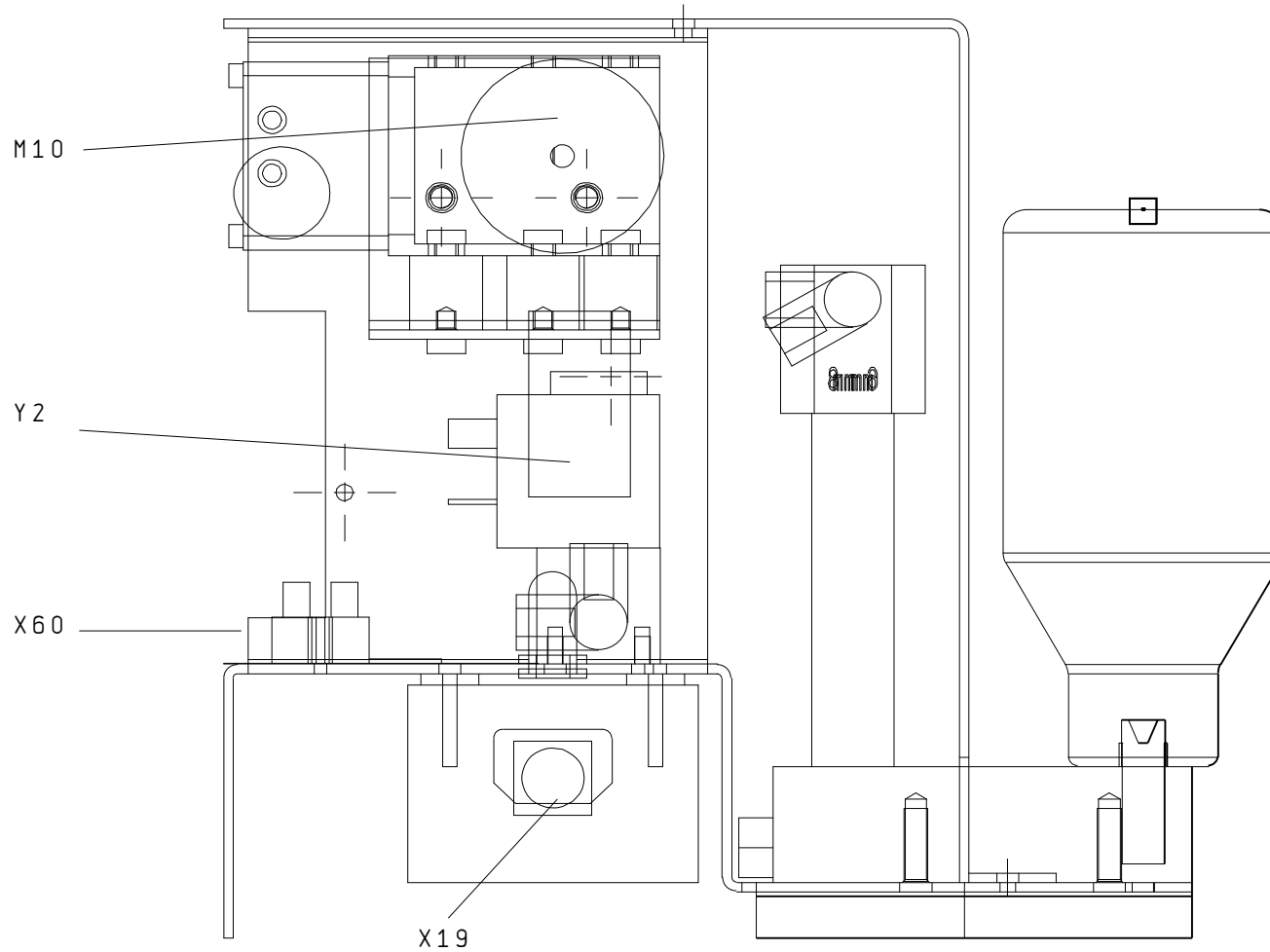

0	1	2	3	4	5	6	7	8	9
	date	Typ 7019/100 HD	aroma module				Zeichnungsnummer		
	drawn	Cayenne					drawing-no.	A7000/467	
2/3	25.07.07	USA					ident. -no. :		page 15
modific.	date	name	norm	origin	repl. for	repl. by	267225	CRD-Version: 5.60.3	57 pages



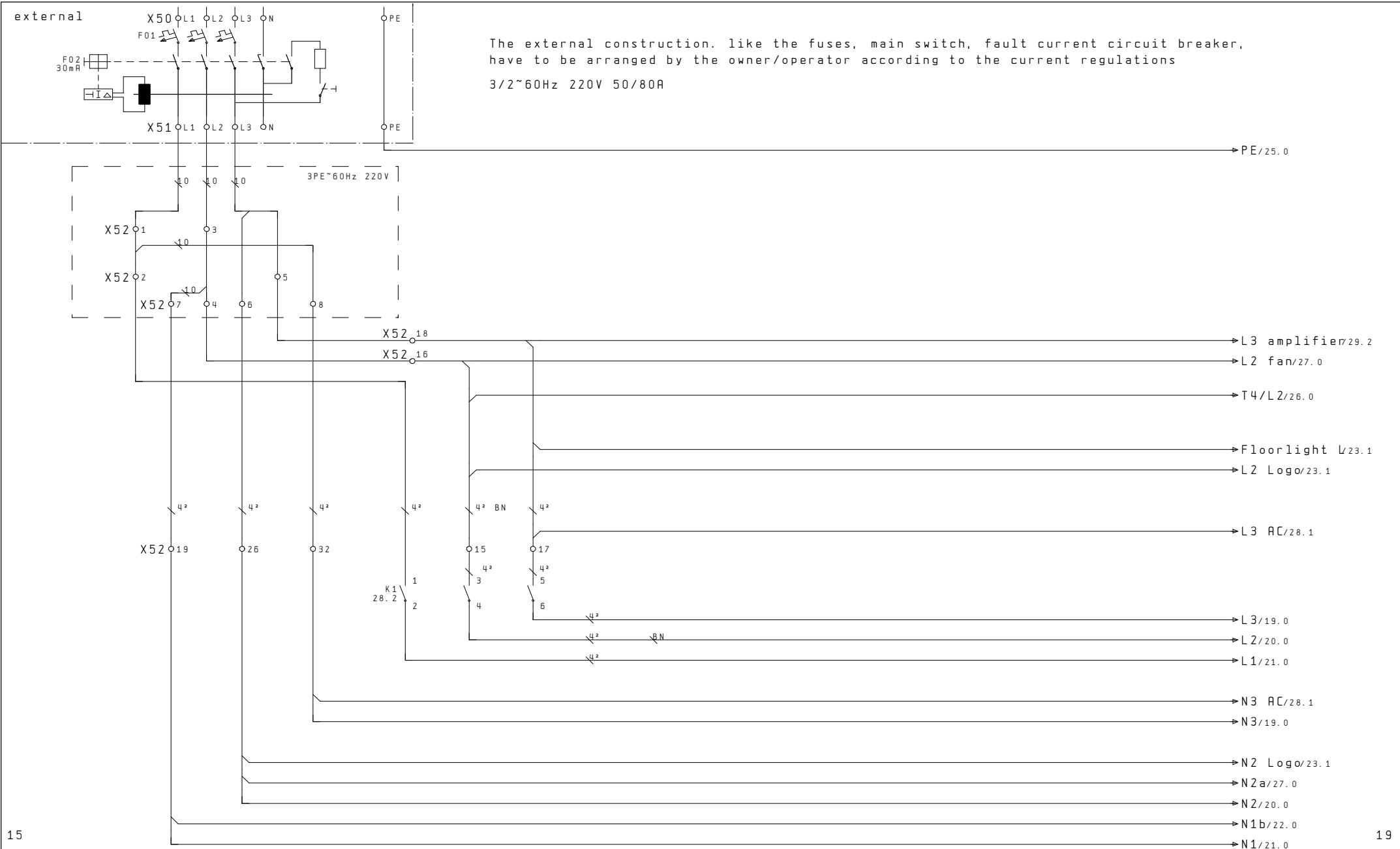

15

19

0	1	2	3	4	5	6	7	8	9
	date	Typ 7019/100 HD	main circuit				Zeichnungsnummer	A7000/467	
	drew	Cayenne					drawing-no.		
2/3~	25.07.07	checked	AKO	USA			ident. -no. :	CAD-Version: 5.60.3	
modific.	date	name	norm	origin	repl. for	266596	repl. by		page 18
									57 pages

uwe GmbH  
Buchstrasse 82 · Postfach 2020  
D-73510 Schwäbisch Gmünd





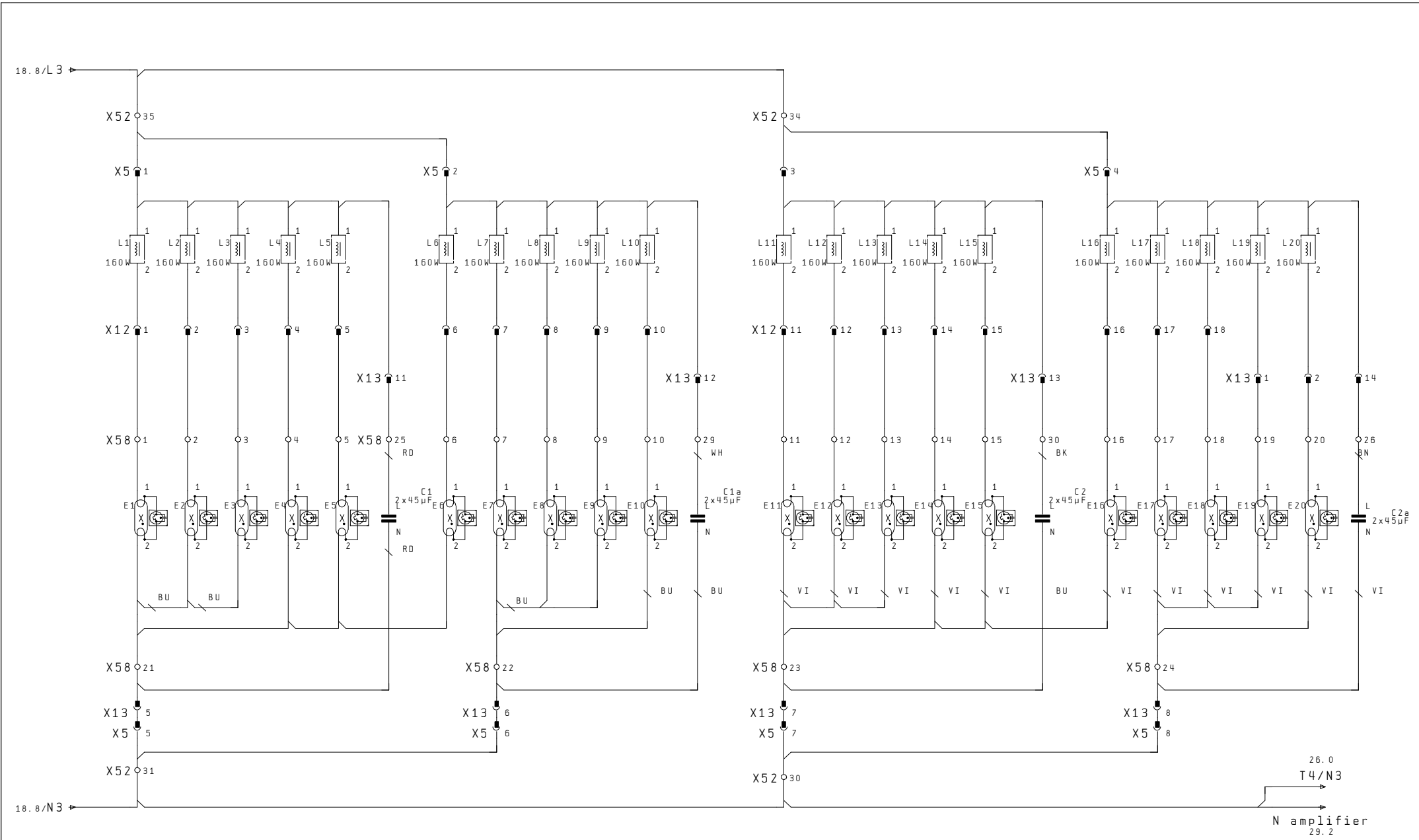

0	1	2	3	4	5	6	7	8	9
	date	Typ 7019/100 HD	base lamps				Zeichnungsnummer	A7000/467	
	drawn	Cayenne					drawing-no.		
2/3~	25.07.07	checked	USA				ident. -no.:	CRD-Version: 5.60.3	page 19
modific.	date	name	norm	origin	repl. for 266596	repl. by	267225		57 pages

UWE GmbH  
 Buchstrasse 82 · Postfach 2020  
 D-73510 Schwäbisch Gmünd



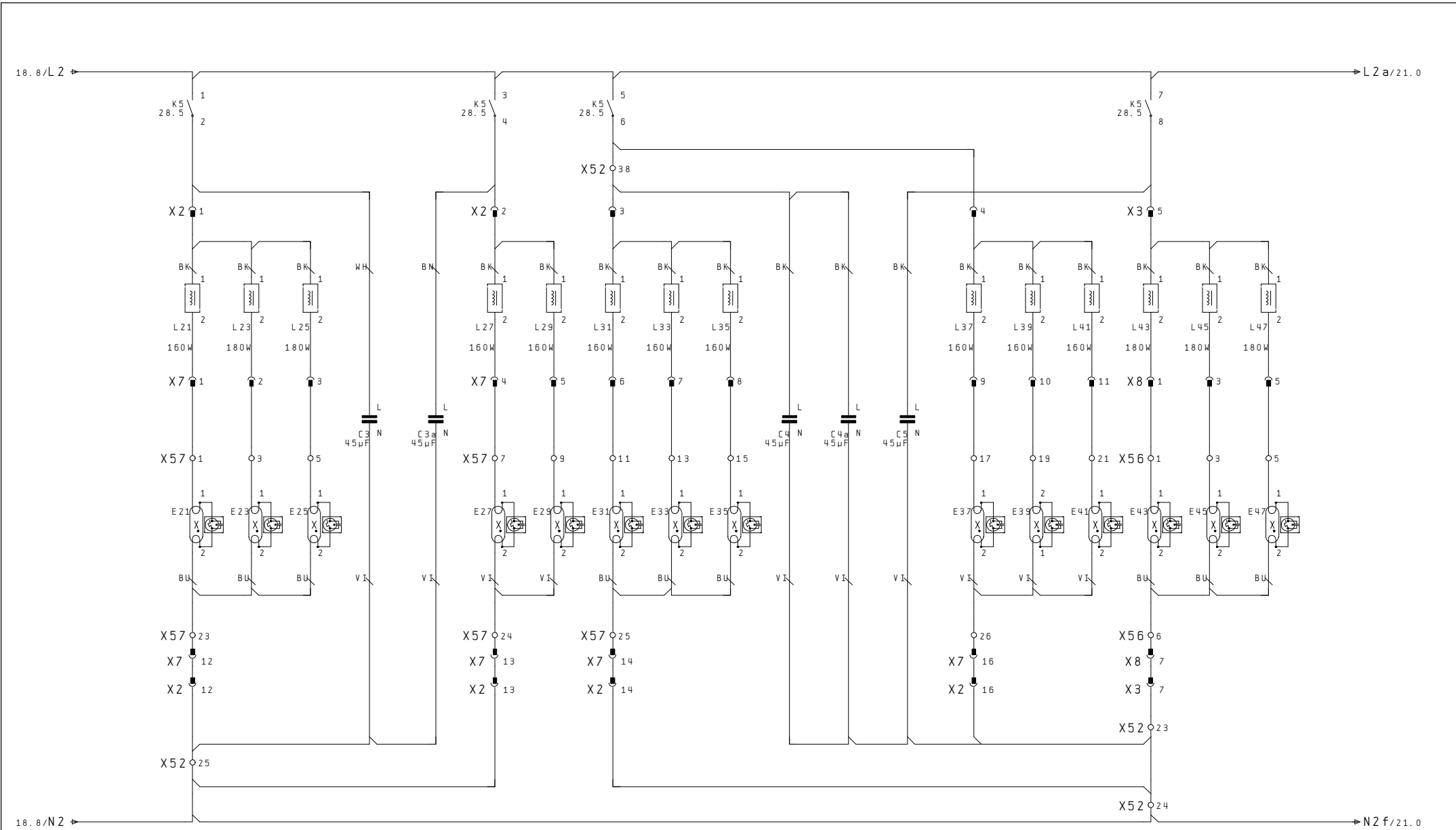

0	1	2	3	4	5	6	7	8	9
	date	Typ 7019/100 HD	canopy lamps				Zeichnungsnummer	A7000/467	
	drawn MAD	Cayenne					drawing-no.		
2/3~	25.07.07	checked RKO	USA				ident. -no.:	CRD-Version: 5.60.3	page 20
modific.	date	name	norm	origin	repl. for 266596	repl. by	267225		57 pages

UWE GmbH  
 Buchstrasse 82 · Postfach 2020  
 D-73510 Schwäbisch Gmünd



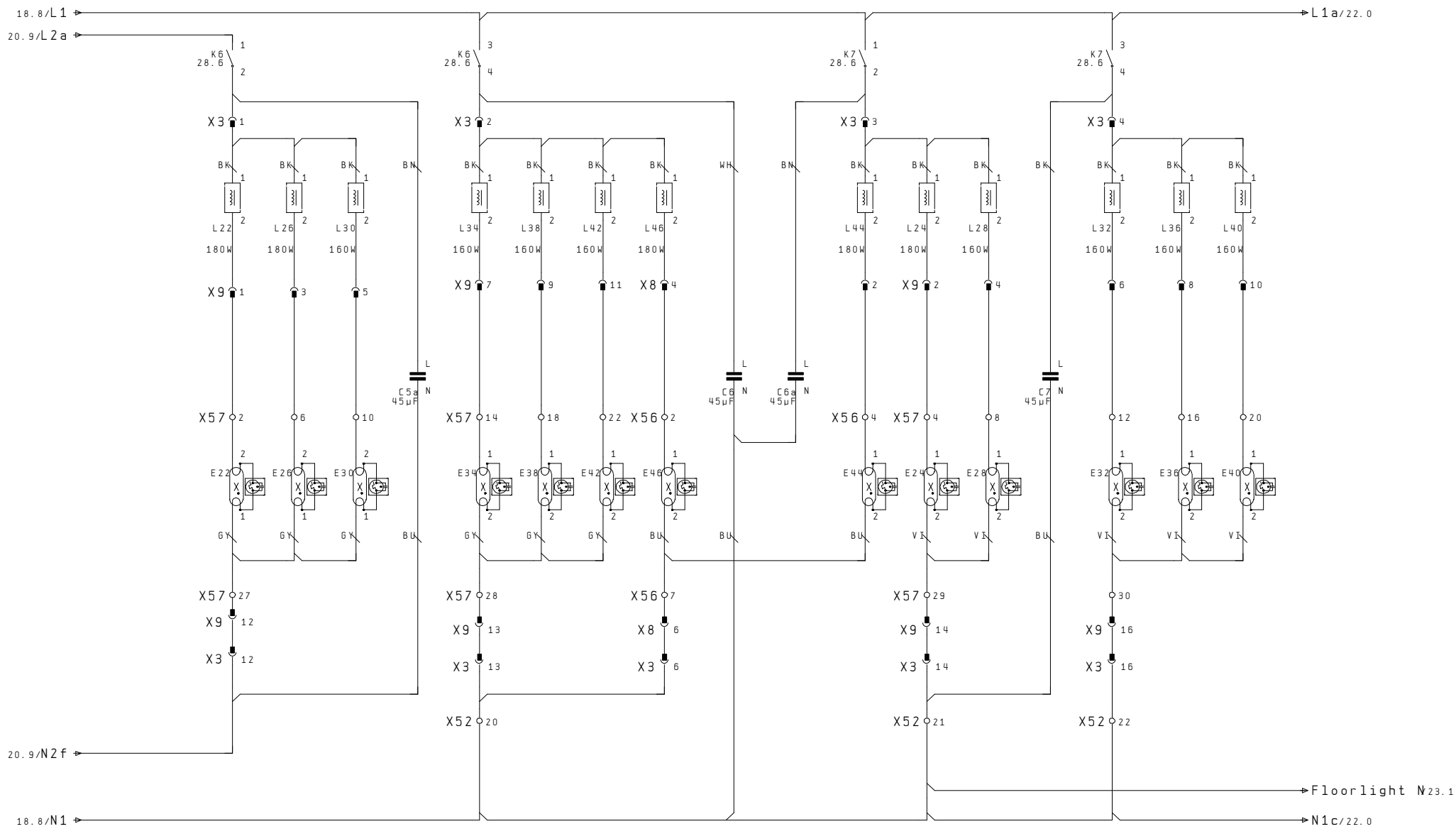

0	1	2	3	4	5	6	7	8	9
	date	Typ 7019/100 HD	canopy lamps				Zeichnungsnummer	A7000/467	
	drawn	Cayenne					drawing-no.		
2/3~	25.07.07	checked	AKO	USA			ident. -no. :	CRD-Version: 5.60.3	page 21
modific.	date	name	norm	origin	repl. for	repl. by	267225		57 pages

UWE GmbH  
 Buchstrasse 82 · Postfach 2020  
 D-73510 Schwäbisch Gmünd



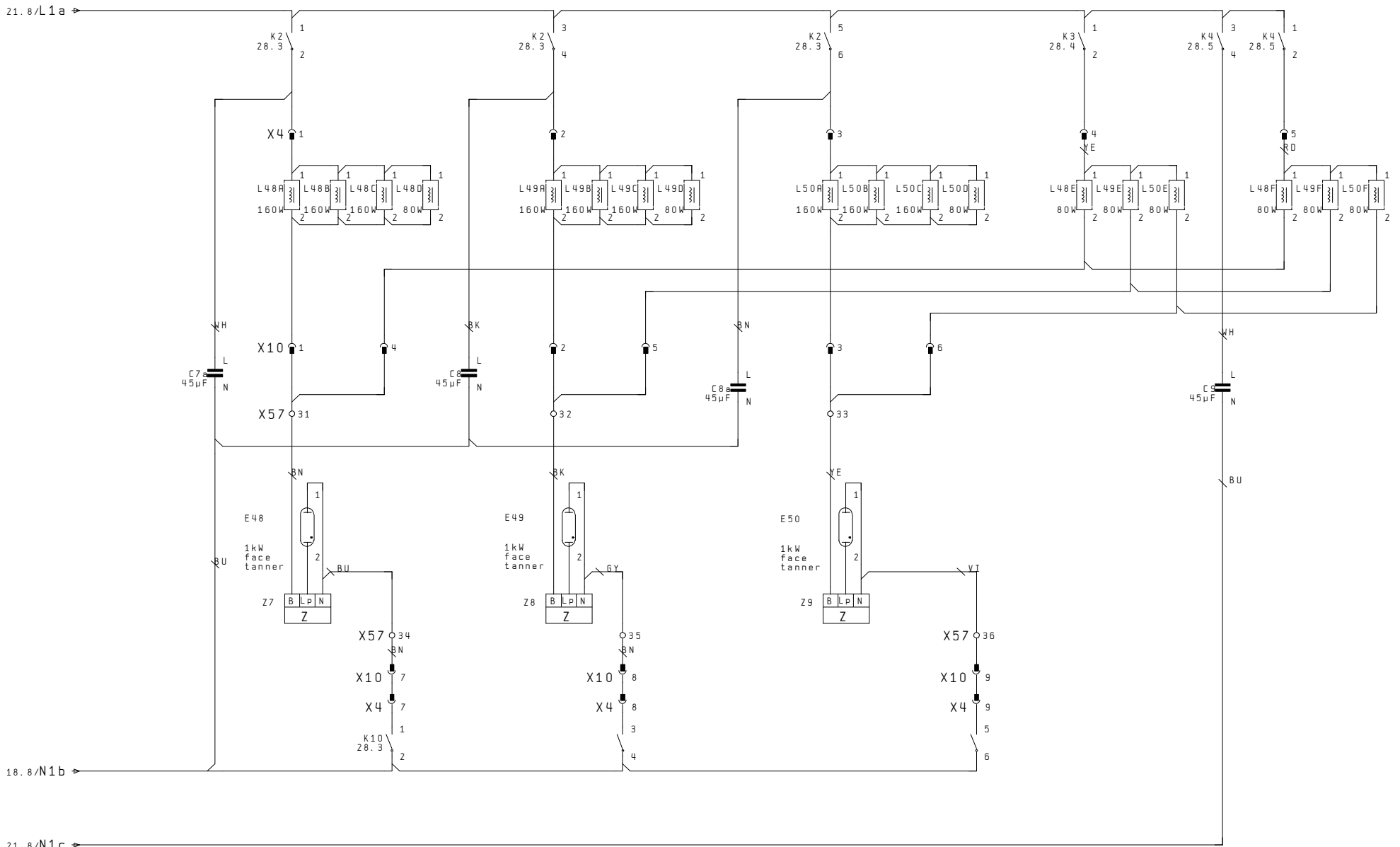

21

21.8/N1c

23

0	1	2	3	4	5	6	7	8	9
	date	Typ 7019/100 HD	HP lamps				Zeichnungsnummer	A7000/467	
	drawn	NOS	Cayenne				drawing-no.		
Z/3~	25.07.07	checked	AKO	USA			ident. -no.:	CRD-Version: 5.60.3	page 22
modific.	date	name	norm	origin	repl. for 266596	repl. by	267225		57 pages

UWE GmbH  
 Buchstrasse 82 · Postfach 2020  
 D-73510 Schwäbisch Gmünd



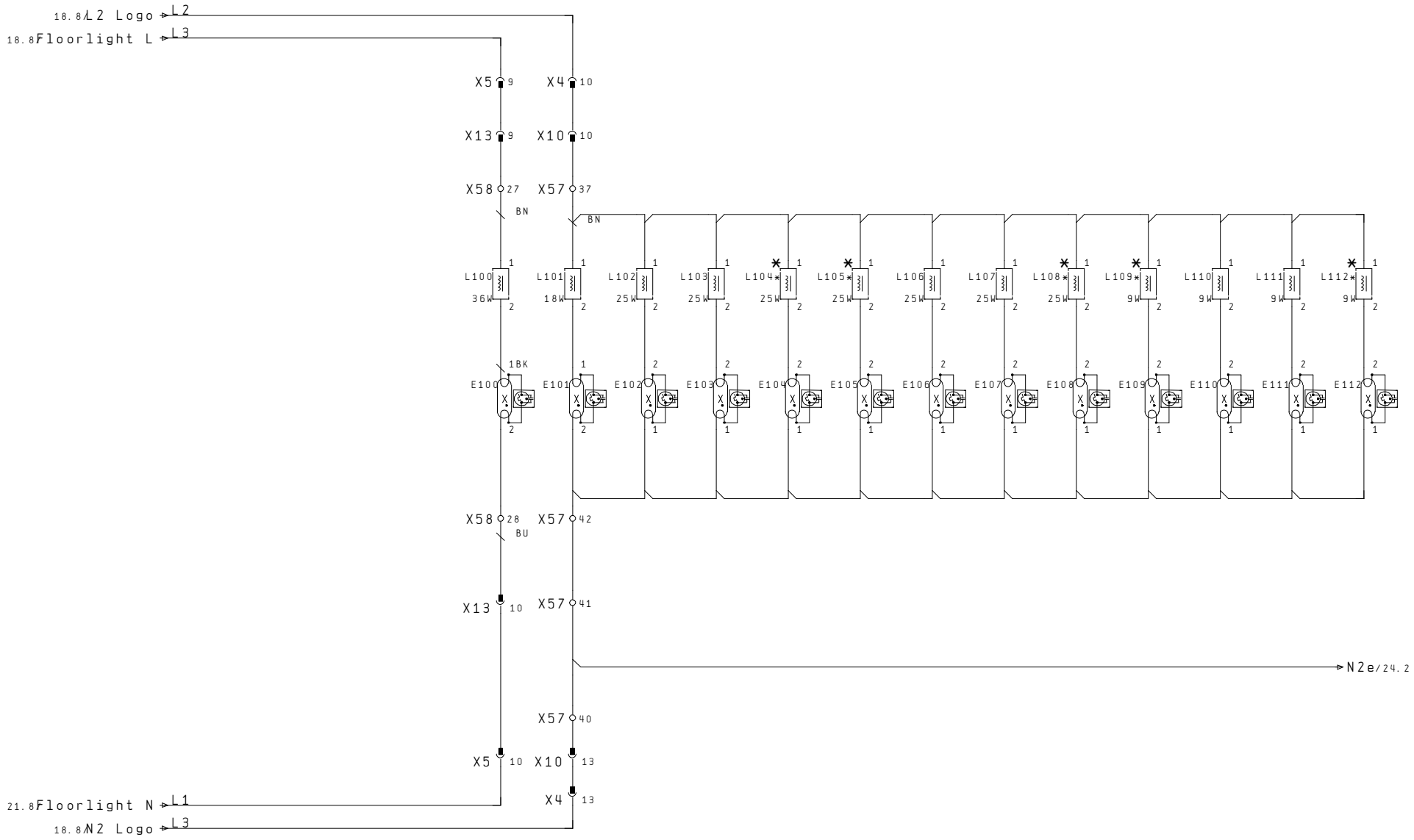

0		1		2		3		4		5		6		7		8		9	
		date		Typ 7019/100 HD		light effects								Zeichnungsnummer					
		drawn		Cayenne										drawing-no.					
2/3~		25.07.07		USA										ident. -no. :		CARD-Version: 5.60.3		page 23	
modific.		date		origin		repl. for 266596		repl. by						267225				57 pages	



The external construction, like the fuses, main switch, fault current circuit breaker, have to be arranged by the owner/operator according to the current regulations

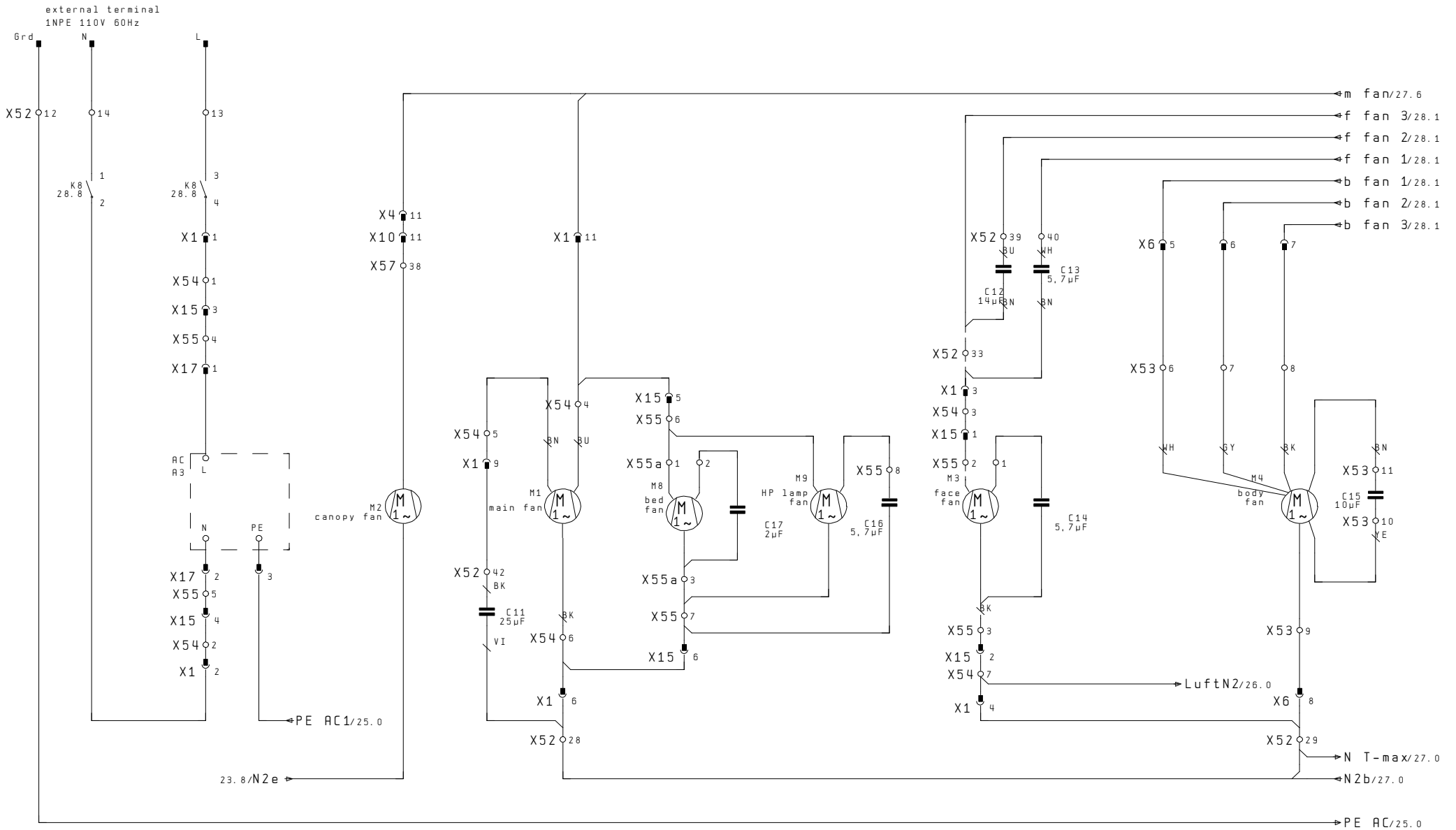

0	1	2	3	4	5	6	7	8	9
	date	Typ 7019/100 HD	fan circuit				Zeichnungsnummer	A7000/467	
	drawn	Cayenne					drawing-no.		
2/3~	25.07.07	USA					ident. -no. :	CAD-Version: 5.60.3	
modific.	date	name	origin	repl. for	repl. by		267225	page	24
				266596				57	pages



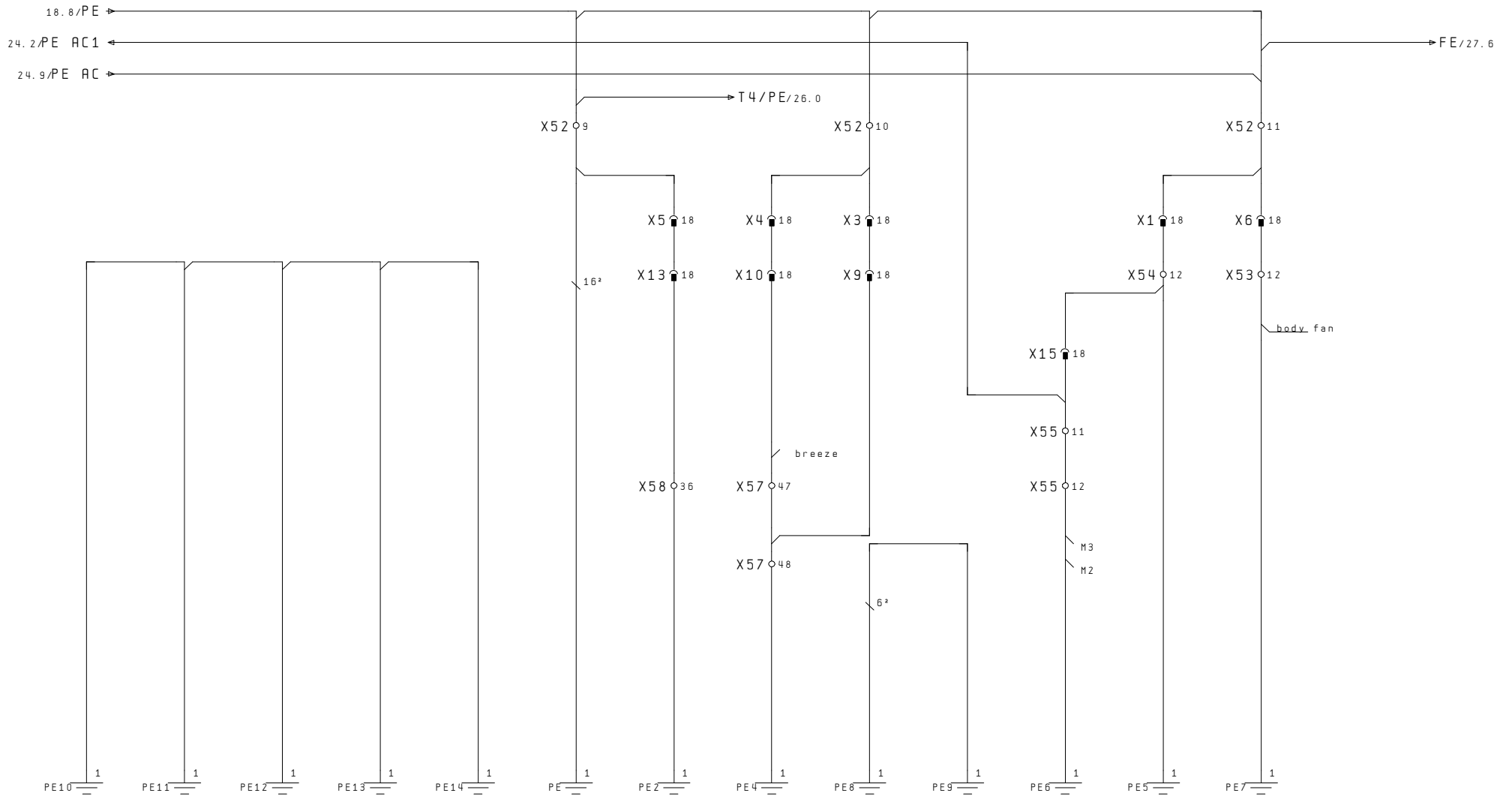

0		1		2		3		4		5		6		7		8		9	
		date		Typ 7019/100 HD		PE								Zeichnungsnummer					
		drawn		Cayenne										drawing-no.					
2/3~		25.07.07		USA										ident. -no. :		CARD-Version: 5.60.3		page 25	
modific.		date		origin		repl. for 266596		repl. by		Uwe GmbH		D-73510 Schwäbisch Gmünd		267225				57 pages	

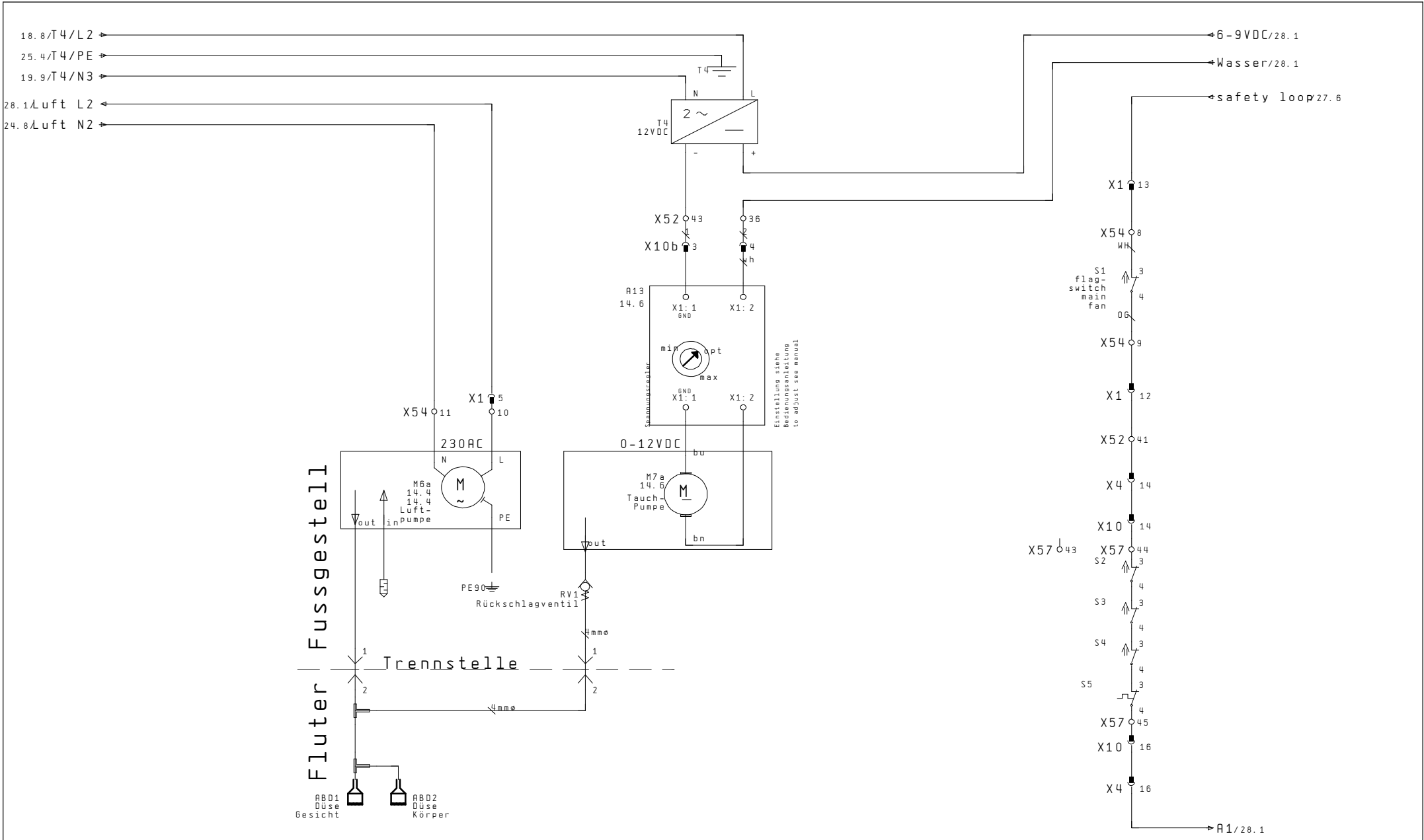

0	1	2	3	4	5	6	7	8	9
	date	Typ 7019/100 HD	breeze				Zeichnungsnummer		
	drawn	Cayenne					drawing-no.	A7000/467	
2/3~	25.07.07	checked	AKO	USA			ident. -no. :		page
modific.	date	name	norm	origin	repl. for	repl. by	267225	267225	57
					266596			5.60.3	26
									pages



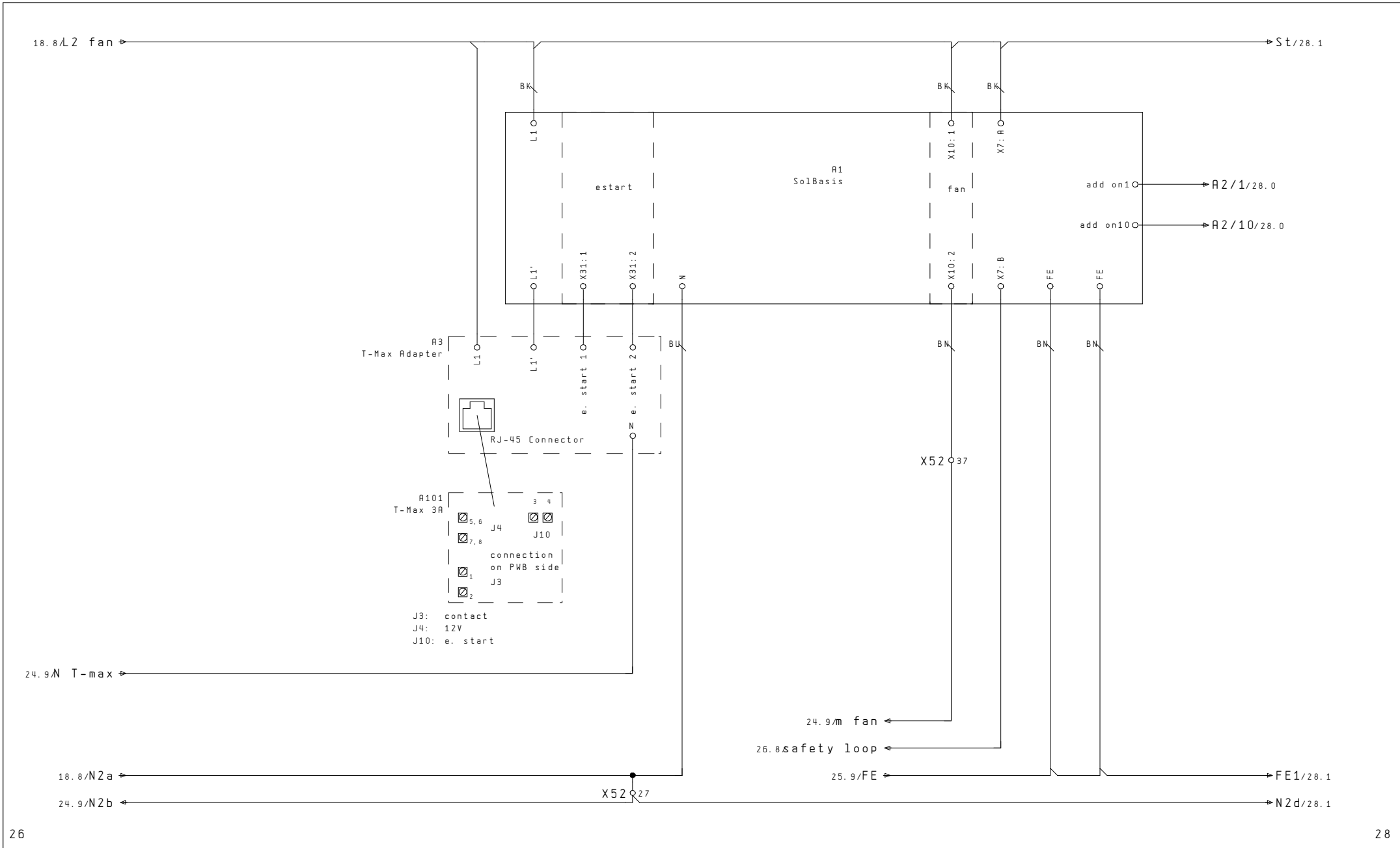

0	1	2	3	4	5	6	7	8	9
	date drawn MAD	Typ 7019/100 HD Cayenne	control circuit				Zeichnungsnummer drawing-no. A7000/467		
2/3	25.07.07	checked AKO	USA		Uwe GmbH Buchstrasse 82 · Postfach 2020 D-73510 Schwäbisch Gmünd	UWE	ident. -no. : 267225	CRD-Version: 5.60.3	page 27
modific.	date	name	norm	origin	repl. for 266596	repl. by	57 pages		

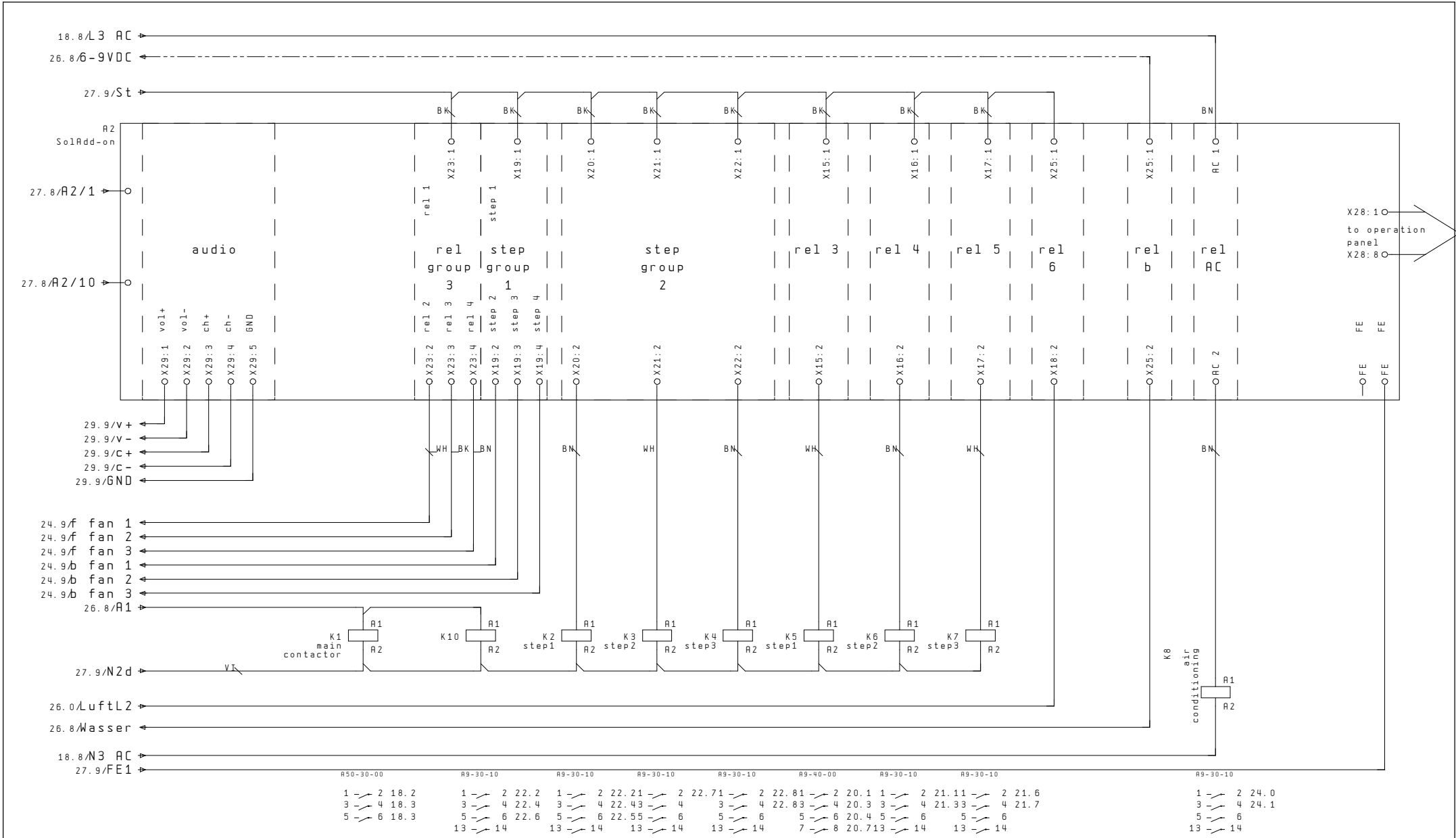

		date	Typ 7019/100 HD	control circuit					
		drawn	Cayenne						
		checked	USA						
2/3	25.07.07								
modific.	date	name	norm	origin	repl. for 266596	repl. by	origin		

**UWE GmbH**  
 Buchstrasse 82 · Postfach 2020  
 D-73510 Schwäbisch Gmünd



Zeichnungsnummer **A7000/467**  
 drawing-no.  
 ident. -no. : 267225  
 CAD-Version: 5.60.3  
 page **28**  
 57 pages

audio interface

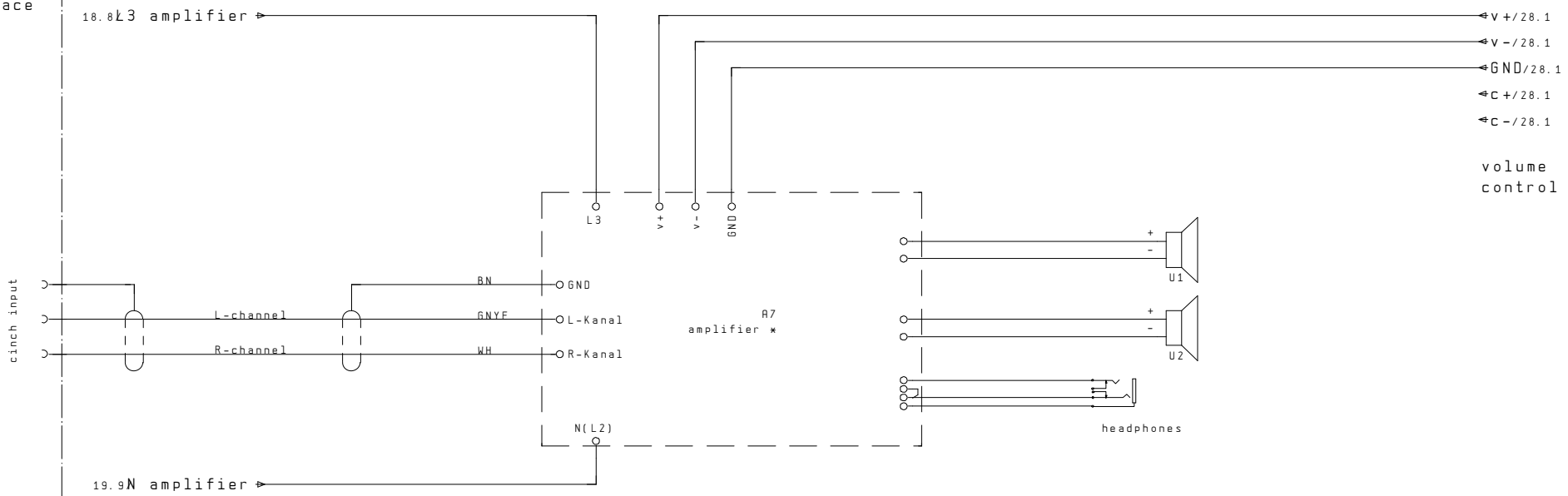

0	1	2	3	4	5	6	7	8	9
	date	Typ 7019/100 HD	audio				Zeichnungsnummer		
	drawn	Cayenne					drawing-no.	A7000/467	
2/3	25.07.07	USA					ident. -no. :		page
modific.	date	name	origin	repl. for	repl. by		267225	5.60.3	29
				266596					57 pages

UWE GmbH  
 Buchstrasse 82 · Postfach 2020  
 D-73510 Schwäbisch Gmünd



# statistic of modifications

mod. no. Änd.-Nr.	mod. date from Änderungsdatum	drawer Zeichner	modification Änderung	shortname Name	page Seite
1	26.11.2004	NOS	added page 5k and 5l		14; 15
2	26.11.2004	NOS	modified page 5		4
3	09.02.05	AK	K10		30
4	02.03.05	AK	K10 modified page 5		5
5	12.10.06	AK	Effektbeleuchtung wie POC		
6	24.11.06	AK	WLRF entfällt		
7	28.12.06	ak	neues breeze		
8	10.01.07	ak	Schaltplan reduziert POC Haubenbeleuchtung integriert. Kennzeichnung durch *		
9	13.04.07	AK	Spannungsregler für Breeze eingepflegt, bitte beachten das evtl klemmen an der x52 übrig sind Steckverbindung zum Spannungsregler als fliegende Verbindung mit zugentlastung auf Steuerplatte		
10	19.04.07	AK	X52 für Netzteil Breeze anschluss ergänzt(nach Netzteil)K10:2, K10:4 und K10:6 gebrückt um Platz auf X52 zu schaffen		
11	20.04.07	AK	Logobeleuchtung auf X52:16 und X52:26 umgeklemt		
12	11.06.07	AK	Mtpl 1 klemme x52 eingezeichnet		
13	10.07.07	AK	Position K10		
14	13.07.07	AK	Adernummer Breezekabel ergänzt		
15					
16					
17					
18					
19					
20					
21					
22					
23					
24					
25					
26					
27					
28					
29					

0		1		2		3		4		5		6		7		8		9	
		date		Typ 7019/100 HD	modifications														
		drawn	MAD	Cayenne															
2/3	25.07.07	checked	AKO	USA															
modific.	date	name	norm	origin	repl. for 266596	repl. by													

UWE GmbH  
 Buchstrasse 82 · Postfach 2020  
 D-73510 Schwäbisch Gmünd



Zeichnungsnummer  
 drawing-no. A7000/467  
 ident.-no.: 267225  
 CAD-Version: 5.60.3  
 page 30  
 57 pages

page/path			24.1	24.1	24.6	24.6	26.3	24.3	24.3	24.4	26.7	26.7	25.7									
terminal block Leistensbezeichnung <b>X1</b>	WX1/X52		1x																			
	cabelname	type	color																			
	connection		4																			
	finish designation		K8																			
	bridges																					
	terminal number		1	2	3	4	5	6	9	11	12	13	18									
	connection		1	2	3	7	10	6	42	4	9	8	12									
	finish designation		X54	X54	X54	X54	X54	X54	X52	X54	X54	X54	X54	X54								
	cabelname	type	color																			

30 **Klemmenplan terminal diagram** 32

date	20.04.07	Typ 7019/100 HD		X1																	
drawn	AKO	Cayenne																			
checked	AKO	USA																			
repl. for	266596	repl. by																			
name	norm	origin																			

**UWE GmbH**  
Buchstrasse 82 · Postfach 2020  
D-73510 Schwäbisch Gmünd

Zeichnungsnummer **A7000/467**  
drawing-no. **A7000/467**  
ident.-no.: **267225**  
CAD-Version: 5.60.3

page **31**  
57 pages

page/path		20.1	20.3	20.4	20.6	20.1	20.3	20.4	20.6
terminal block Leistensbezeichnung <b>X2</b>	connection	2							
	finish designation	K5	K5	X52	K5	X52	X52	X52	X52
	bridges								
	terminal number	1	2	3	4	12	13	14	16
	connection	1	1	1	1	12	13	14	16
	finish designation	L21	L27	L31	L37	X7	X7	X7	X7
cabelname	type	color							
		BK	X	X	X	X			

31 Klemmenplan terminal diagram 33

date		20.04.07		Typ 7019/100 HD		X2	
drawn		AKO		Cayenne			
checked		AKO		USA			
Z/3~		25.07.07		repl. for 266596		repl. by	
modific. date		name norm		origin		repl. by	

UWE GmbH  
 Buchstrasse 82 · Postfach 2020  
 D-73510 Schwäbisch Gmünd



Zeichnungsnummer  
 drawing-no. A7000/467

ident. -no. : CAD-Version: 5.60.3 page 32  
 267225 57 pages

terminal block Leistenbezeichnung		cabelname		type	color	connection	finish designation	bridges	terminal number	connection	finish designation	page/path
X3												21.1
							K6		1	L22		21.3
							K6		2	L34		21.6
							K7		3	L44		21.7
							K7		4	L32		20.7
							K5		5	L43		21.4
							X52		6	X8		20.7
							X52		7	X8		21.1
							X52		12	X9		21.3
							X52		13	X9		21.6
							X52		14	X9		21.7
							X52		16	X9		25.5
							X52		18	X9		

32 Klemmenplan terminal diagram 34

date 20.04.07		Typ 7019/100 HD		X3		Zeichnungsnummer A7000/467	
drawn RKO		Cayenne				drawing-no.	
checked RKO		USA				ident. -no. :	
2/3~ 25.07.07		repl. for 266596		repl. by		CAD-Version: 5.60.3 page 33	
modific. date name norm		origin		repl. by		267225 57 pages	



UWE		ident. -no. : 267225		CAD-Version: 5.60.3		page 33	
						57 pages	

page/path		22.2	22.4	22.5	22.7	22.8	22.2	22.4	22.6	23.3	24.2	23.3	26.7	26.7	25.4
WX4/X52	1x 4mm² BN								X	1					
terminal block Leistenbezeichnung <b>X4</b>	cabelname														
	type														
	color														
	connection	2	4	6	2	2	1	3	5	15	37	26	14	81	10
	finish designation	K2	K2	K2	K3	K4	K10	K10	K10	X52	X52	X52	X10	K1	X52
	bridges														
terminal number	1	2	3	4	5	7	8	9	10	11	13	14	16	18	
connection	L48A	L48A	L50A	L48E	L48F	X10	X10	X10	X10	X10	X10	X52	X10	X10	
finish designation															
cabelname															
type															
color															
	YE				X										
	RD					X									

33 Klemmenplan terminal diagram 35

0	1	2	3	4	5	6	7	8	9
	date 20.04.07	Typ 7019/100 HD	X4						
	drawn AKO	Cayenne							
2/3	25.07.07	checked AKO	USA						
modific.	date	name	norm	origin	repl. for 266596	repl. by			

UWE GmbH  
 Buchstrasse 82 · Postfach 2020  
 D-73510 Schwäbisch Gmünd



Zeichnungsnummer A7000/467  
 drawing-no.  
 ident. -no. : 267225  
 CAD-Version: 5.60.3  
 page 34  
 57 pages



terminal block Leistenbezeichnung		cabelname		type	color	connection	finish designation	bridges	terminal number	connection	finish designation	page/path
X5	1	L1	1	1		35	X52		1	1	L1	19.1
	2	L6	1	2		35	X52		2	1	L6	19.3
	3	L11	1	3		34	X52		3	1	L11	19.5
	4	L16	1	4		34	X52		4	1	L16	19.7
	5	X13	5	5		31	X52		5	5	X13	19.1
	6	X13	6	6		31	X52		6	6	X13	19.3
	7	X13	7	7		30	X52		7	7	X13	19.5
	8	X13	8	8		30	X52		8	8	X13	19.8
	9	X13	9	9		18	X52		9	9	X13	23.3
	10	X52	21	10		10	X13		10	21	X52	23.3
18	X13	18	18		9	X52		18	18	X13	25.4	

34 Klemmenplan terminal diagram

date 20.04.07		Typ 7019/100 HD		X5		Zeichnungsnummer A7000/467	
drawn RKO		Cayenne				drawing-no.	
checked RKO		USA				ident. -no. :	
2/3~ 25.07.07		repl. for 266596		repl. by		CAD-Version: 5.60.3	
modific. date name norm		origin		repl. by		page 35	
						57 pages	

UWE GmbH  
 Buchstrasse 82 · Postfach 2020  
 D-73510 Schwäbisch Gmünd



page/path		24.7	24.8	24.8	24.8	25.7
terminal block Leistenbezeichnung <b>X6</b>	connection	A2 X19:2	A2 X19:3	A2 X19:4	X52 29	X52 11
	finish designation					
	bridges					
	terminal number	5	6	7	8	18
	connection	6	7	8	9	12
	finish designation	X53	X53	X53	X53	X53
cabelname type color						

0		1		2		3		4		5		6		7		8		9	
		date 20.04.07		Typ 7019/100 HD		X6													
		drawn AKO		Cayenne															
2/3~		25.07.07		checked AKO		USA													
modific. date name norm		origin		repl. for 266596		repl. by													

UWE GmbH  
 Buchstrasse 82 · Postfach 2020  
 D-73510 Schwäbisch Gmünd



Zeichnungsnummer **A7000/467**  
 drawing-no.  
 ident.-no.: 267225  
 CAD-Version: 5.60.3  
 page **36**  
 57 pages

terminal block Leistenbezeichnung		cabelname		type	color	connection	finish designation	bridges	terminal number	connection	finish designation	page/path
<b>X7</b>		X57	1	1			L21		1			20.1
		X57	3	2			L23		2			20.1
		X57	5	3			L25		3			20.2
		X57	7	4			L27		4			20.3
		X57	9	5			L29		5			20.3
		X57	11	6			L31		6			20.4
		X57	13	7			L33		7			20.4
		X57	15	8			L35		8			20.5
		X57	17	9			L37		9			20.6
		X57	19	10			L39		10			20.7
		X57	21	11			L41		11			20.7
		X57	23	12			X2	L12		12		20.1
		X57	24	13			X2	L13		13		20.3
		X57	25	14			X2	L14		14		20.4
		X57	26	16			X2	L16		16		20.6

2/3~		25.07.07	checked	AKO	Typ 7019/100 HD Cayenne USA	X7	Uwe GmbH Buchstrasse 82 · Postfach 2020 D-73510 Schwäbsch Gmünd		Zeichnungsnummer drawing-no. <b>A7000/467</b>		ident. -no. : 267225		CAD-Version: 5.60.3		page <b>37</b>
modific.	date	name	norm		origin	repl. for 266596	repl. by	UWE		page <b>37</b>		57 pages			

page/path		20.7	21.6	20.8	21.4	20.8	21.4	20.7												
terminal block Leistenbezeichnung <b>X8</b>	connection	2																		
	finish designation	L43	L44	L45	L46	L47	X3	X3												
	bridges																			
	terminal number	1	2	3	4	5	6	7												
	connection	1	4	3	2	5	7	6												
	finish designation	X56	X56	X56	X56	X56	X56	X56	X56											
cabelname type color																				

37 Klemmenplan terminal diagram 39

date 20.04.07		Typ 7019/100 HD		X8		Zeichnungsnummer A7000/467	
drawn AKO		Cayenne				drawing-no.	
checked AKO		USA				ident.-no. : 267225	
repl. for 266596		repl. by		UWE GmbH		CAD-Version: 5.60.3	
repl. by		repl. by		Buchstrasse 82 · Postfach 2020		page 38	
repl. by		repl. by		D-73510 Schwäbisch Gmünd		57 pages	

terminal block Leistenbezeichnung		cabelname		type	color	connection	finish designation	bridges	terminal number	connection	finish designation	page/path
X9		X57	2	1		L22			2			21.1
		X57	4	2		L24			2			21.6
		X57	6	3		L26			2			21.2
		X57	8	4		L28			2			21.6
		X57	10	5		L30			2			21.2
		X57	12	6		L32			2			21.7
		X57	14	7		L34			2			21.3
		X57	16	8		L36			2			21.8
		X57	18	9		L38			2			21.3
		X57	20	10		L40			2			21.8
		X57	22	11		L42			2			21.4
		X57	27	12		X3	12					21.1
		X57	28	13		X3	13					21.3
		X57	29	14		X3	14					21.6
		X57	30	16		X3	16					21.7
		X57	48	18		X3	18					25.5

38 Klemmenplan terminal diagram 40

date 20.04.07		Typ 7019/100 HD		X9		Zeichnungsnummer A7000/467	
drawn RKO		Cayenne				drawing-no.	
checked RKO		USA				ident. -no. :	
2/3~ 25.07.07		repl. for 266596		repl. by		CAD-Version: 5.60.3	
modific. date name norm		origin		repl. by		page 39	
						57 pages	

UWE GmbH  
 Buchstrasse 82 · Postfach 2020  
 D-73510 Schwäbisch Gmünd



terminal block Leistenbezeichnung		cabelname		type	color	connection	finish designation	bridges	terminal number	connection	finish designation	page/path
X10		X57	31	1		L48A	2					22.2
		X57	32	2		L49A	2					22.4
		X57	33	3		L50A	2					22.5
		X57	31	4		L48E	2					22.2
		X57	32	5		L49E	2					22.4
		X57	33	6		L50E	2					22.6
		X57	34	7		X4	7					22.2
		X57	35	8		X4	8					22.4
		X57	36	9		X4	9					22.6
		X57	37	10		X4	10					23.3
		X57	38	11		X4	11					24.2
		X57	40	13		X4	13					23.3
		X4	14	14		X57	44					26.7
		X57	45	16		X4	16					26.7
		X57	47	18		X4	18					25.4

39 Klemmenplan terminal diagram 41

date 20.04.07		Typ 7019/100 HD		X10		Zeichnungsnummer A7000/467	
drawn RKO		Cayenne				drawing-no.	
checked RKO		USA				ident.-no. : 267225	
repl. for 266596		repl. by		UWE GmbH		CAD-Version: 5.60.3	
repl. by				Buchstrasse 82 · Postfach 2020		page 40	
				D-73510 Schwäbisch Gmünd		57 pages	

terminal block Leistenbezeichnung		cabelname		type	color	connection	finish designation	bridges	terminal number	connection	finish designation	cabelname		type	color	page/path
X12		X58	1	1		L1			1			X58				19.1
		X58	2	2		L2			2			X58				19.1
		X58	3	3		L3			3			X58				19.1
		X58	4	4		L4			4			X58				19.2
		X58	5	5		L5			5			X58				19.2
		X58	6	6		L6			6			X58				19.3
		X58	7	7		L7			7			X58				19.3
		X58	8	8		L8			8			X58				19.3
		X58	9	9		L9			9			X58				19.4
		X58	10	10		L10			10			X58				19.4
		X58	11	11		L11			11			X58				19.5
		X58	12	12		L12			12			X58				19.5
		X58	13	13		L13			13			X58				19.6
		X58	14	14		L14			14			X58				19.6
		X58	15	15		L15			15			X58				19.6
		X58	16	16		L16			16			X58				19.7
		X58	17	17		L17			17			X58				19.8
		X58	18	18		L18			18			X58				19.8

40 Klemmenplan terminal diagram 42

2/3~		25.07.07	name	norm	origin	repl. for 266596	repl. by	Zeichnungsnummer <b>A7000/467</b> drawing-no.		ident.-no.:	267225	CAD-Version: 5.60.3 page <b>41</b> 57 pages
------	--	----------	------	------	--------	------------------	----------	--	--	-------------	--------	---

UWE.le111





page/path		24.6	24.6	24.1	24.1	24.4	24.4	25.6												
terminal block Leistenszeichnung <b>X15</b>	cabelname																			
	type																			
	color																			
	connection	3																		
	finish designation	X54	X54	X54	X54	X54	X54	X54	X54											
	bridges																			
	terminal number	1	2	3	4	5	6	18												
	connection	2	3	4	5	6	7	11												
	finish designation	X55	X55	X55	X55	X55	X55	X55												
	cabelname																			
type																				
color																				

42 Klemmenplan terminal diagram 44

0		1		2		3		4		5		6		7		8		9	
		date	20.04.07	Typ 7019/100 HD		X15													
		drawn	AKO	Cayenne															
2/3	25.07.07	checked	AKO	USA															
modific.	date	name	norm	origin	repl. for	266596	repl. by												

UWE GmbH  
 Buchstrasse 82 · Postfach 2020  
 D-73510 Schwäbisch Gmünd



Zeichnungsnummer A7000/467  
 drawing-no.

ident.-no.: 267225  
 CAD-Version: 5.60.3  
 page 43  
 57 pages

page/path	26.6		26.6															

	cabelname	type	color
terminal block Leistenbezeichnung <b>X16</b>	connection		11
	finish designation		X54
			X54 10
	bridges		
	terminal number		1
			2
connection			
finish designation		S6	
		H6	

Klemmenplan terminal diagram

0	1	2	3	4	5	6	7	8	9
	date	24.11.06	Typ 7019/100 HD	X16					
	drawn	AKO	Cayenne						
2/3~	25.07.07	checked	AKO	USA					
modific.	date	name	norm	origin	repl. for	266596	repl. by		

uwe GmbH  
Buchstrasse 82 · Postfach 2020  
D-73510 Schwäbisch Gmünd



Zeichnungsnummer A7000/467

ident. -no.: 267225  
CAD-Version: 5.60.3 page 44  
57 pages





page/path		18.1	18.1	18.1	18.1	18.2
-----------	--	------	------	------	------	------

cabelname		type	color
terminal block Leistenbezeichnung X51	connection		PE
	finish designation	F02	F02
	bridges		
	terminal number	N	L1
	connection	1	L2
	finish designation	X52	X52

cabelname		type	color
-----------	--	------	-------

46 Klemmenplan terminal diagram

		date	20.04.07	Typ 7019/100 HD	X51		
		drawn	AKO	Cayenne			
2/3	25.07.07	checked	AKO	USA			
modific. date		name	norm	origin	repl. for 266596	repl. by	
uwe GmbH Buchstrasse 82 · Postfach 2020 D-73510 Schwäbsch Gmünd 					Zeichnungsnummer drawing-no. <b>A7000/467</b>		
						ident. -no. :	CAD-Version: 5.60.3
						267225	page <b>47</b> 57 pages

terminal block Leistenbezeichnung		X52		connection		finish designation		bridges		terminal number		connection		finish designation		cabelname		type		color		WH		VI		BU		BN		page/path	
										1																				18.1	
										2																				18.1	
										3																				18.1	
										4																				18.1	
										5																				18.2	
										6																				18.1	
										7																				18.1	
										8																				18.2	
										9																				25.3	
										10																				25.5	
										11																				25.7	
										12																				24.0	
										13																				24.1	
										14																				24.0	
										15																				18.3	
										16																				18.2	
										17																				18.3	
										18																				18.2	
										19																				18.1	
										20																				21.3	
										21																				21.6	
										22																				21.7	
										23																				20.7	
										24																				20.7	
										25																				20.1	
										26																				18.1	
										27																				27.4	
										28																				24.3	
										29																				24.8	
										30																				19.5	
										31																				19.1	
										32																				18.2	
										33																				24.6	
										34																				19.5	
										35																				19.1	
										36																				26.5	
										37																				27.6	
										38																				20.4	
										39																				24.6	
										40																				24.7	

47 Klemmenplan terminal diagram 49

date 20.04.07		Typ 7019/100 HD		X52	
drawn AKO		Cayenne			
checked AKO		USA			
repl. for 266596		repl. by			

Uwe GmbH  
 Buchstrasse 82 · Postfach 2020  
 D-73510 Schwäbisch Gmünd

Zeichnungsnummer A7000/467  
 drawing-no.

ident.-no.: 267225  
 CAD-Version: 5.60.3  
 page 48  
 57 pages

UWE13111



page/path		24.7	24.8	24.8	24.8	24.9	24.9	25.7												
terminal block Leistensbezeichnung <b>X53</b>	BN						X													
	cabelname																			
	type																			
	color																			
	connection	5																		
	finish designation	X6	X6	X6	M4	C15	M4	X6	18											
	bridges																			
	terminal number	6	7	8	9	10	11	12												
	connection				8			1												
	finish designation	M4	M4	M4	X6	M4	C15	PE7												
	cabelname																			
	type																			
color																				
WH	X																			
GY		X																		
BK			X																	
YE					X															

49 Klemmenplan terminal diagram 51

0	1	2	3	4	5	6	7	8	9
	date	20.04.07	Typ 7019/100 HD	X53					
	drawn	AKO	Cayenne						
2/3	25.07.07	checked	AKO	USA					
modific.	date	name	norm	origin	repl. for	266596	repl. by		
UWE GmbH Buchstrasse 82 · Postfach 2020 D-73510 Schwäbisch Gmünd							Zeichnungsnummer drawing-no. <b>A7000/467</b>		ident. -no. : 267225
								CAD-Version: 5.60.3	page <b>50</b> 57 pages





page/path		24.6	24.6	24.6	24.1	24.1	24.4	24.4	24.6	25.6	25.6
BK				X							
terminal block Leistenbezeichnung <b>X55</b>	cabelname										
	type										
	color										
	connection										
	finish designation	C14	X15	M3	C14	X15	X17	X15	X17		
	bridges										
	terminal number	1	2	3	4	5	6	7	8	11	12
	connection			2	1	4	1	6			1
	finish designation	M3	M3	X15	X17	X15	X55a	M9	C16	C16	PE6
	cabelname										
	type										
	color										

51 Klemmenplan terminal diagram 53

date		20.04.07		Typ 7019/100 HD		X55	
drawn		AKO		Cayenne			
checked		AKO		USA			
date		25.07.07		repl. for 266596		repl. by	
name		norm		origin			

**UWE GmbH**  
Buchstrasse 82 · Postfach 2020  
D-73510 Schwäbisch Gmünd

Zeichnungsnummer **A7000/467**  
drawing-no.

ident. -no. : 267225

CRD-Version: 5.60.3

page <b>52</b>	57 pages
----------------	----------

page/path		20.7	21.4	20.8	21.6	20.8	20.7	21.4												
terminal block Leistensbezeichnung <b>X56</b>	connection	1	4	3	2	5	7	6												
	finish designation	X8	X8	X8	X8	X8	X8	X8												
	bridges																			
	terminal number	1	2	3	4	5	6	7												
	connection	1	1	1	1	1	2	2												
	finish designation	E43	E46	E45	E44	E47	E43	E46												
cabelname type color																				
		BU					X	X												

52 Klemmenplan terminal diagram 54

			date	20.04.07	Typ 7019/100 HD	X56														
			drawn	AKO	Cayenne															
2/3~	25.07.07		checked	AKO	USA															
modific.	date	name	norm	origin	repl. for	266596	repl. by													

UWE GmbH  
 Buchstrasse 82 · Postfach 2020  
 D-73510 Schwäbisch Gmünd



Zeichnungsnummer  
 drawing-no. A7000/467

ident.-no.: 267225  
 CAD-Version: 5.60.3  
 page 53  
 57 pages

terminal block Leistensbezeichnung	X57	cabelname		type	color	connection	finish designation	bridges	terminal number	connection	finish designation	cabelname		type	color	BU	VI	GY	BN	BK	YE	page/path
																						20.1
																						20.1
																						20.1
																						21.6
																						20.2
																						21.2
																						20.3
																						21.6
																						20.3
																						21.2
																						20.4
																						21.7
																						20.4
																						21.3
																						20.5
																						21.8
																						20.6
																						21.3
																						20.7
																						21.8
																						20.7
																						21.4
																						20.1
																						20.3
																						20.4
																						20.6
																						21.1
																						21.3
																						21.6
																						21.7
																						22.2
																						22.4
																						22.5
																						22.2
																						22.4
																						22.6
																						23.3
																						24.2
																						23.3
																						23.3

### Klemmenplan terminal diagram

date 20.04.07		Typ 7019/100 HD		X57	
drawn AKO		Cayenne			
checked AKO		USA			
repl. for 266596		repl. by			
name norm		origin			

**Uwe GmbH**  
 Buchstrasse 82 · Postfach 2020  
 D-73510 Schwäbisch Gmünd

Zeichnungsnummer  
drawing-no. **A7000/467**

ident.-no.: 267225

page **54**  
57 pages

page/path		23.3	26.7	26.7	26.7	25.4	25.4													
terminal block Leistenbezeichnung <b>X57</b>	connection	2		14	4	18	18													
	finish designation	E101		X10	S5	X10	X9													
	bridges	42	43																	
	terminal number	42	43	44	45	47	48													
	connection			3	16		1													
	finish designation			S2	X10		PE4													
cabelname type color																				
WX57/PE4		1x																		

54 **Klemmenplan terminal diagram** 56

date 20.04.07		Typ 7019/100 HD		X57		Zeichnungsnummer A7000/467	
drawn AKO		Cayenne				drawing-no.	
checked AKO		USA				ident.-no. : 267225	
2/3~ 25.07.07		repl. for 266596		repl. by		CAD-Version: 5.60.3 page 55	
modific. date name norm		origin		repl. for 266596		57 pages	

UWE GmbH  
 Buchstrasse 82 · Postfach 2020  
 D-73510 Schwäbisch Gmünd



terminal block Leistenbezeichnung		cabelname		type	color	connection	finish designation	bridges	terminal number	connection	finish designation	RD	BU	VI	BN	WH	BK	page/path		
X58		E1		1		1	X12		1									19.1		
		E2		1		2	X12		2										19.1	
		E3		1		3	X12		3										19.1	
		E4		1		4	X12		4											19.2
		E5		1		5	X12		5											19.2
		E6		1		6	X12		6											19.3
		E7		1		7	X12		7											19.3
		E8		1		8	X12		8											19.3
		E9		1		9	X12		9											19.4
		E10		1		10	X12		10											19.4
		E11		1		11	X12		11											19.5
		E12		1		12	X12		12											19.5
		E13		1		13	X12		13											19.6
		E14		1		14	X12		14											19.6
		E15		1		15	X12		15											19.6
		E16		1		16	X12		16											19.7
		E17		1		17	X12		17											19.8
		E18		1		18	X12		18											19.8
		E19		1		19	X13		1											19.8
		E20		1		20	X13		2											19.9
		E21		5		21	E1		2											19.1
		E22		6		22	E4		2											19.3
		E23		7		23	E7		2											19.5
		E24		8		24	E10		2											19.8
		E25		8		25	E11		2											19.2
		E26		10		26	E14		2											19.9
		E27		10		27	E17		2											23.3
		E28		10		28	E20		2											23.3
		E29		10		29	E13		11											19.4
		E30		10		30	X13		12											19.7
E36		1		36	X13		18											25.4		

2/3~		25.07.07	checked	AKO	Typ 7019/100 HD	X58	Uwe GmbH Buchstrasse 82 · Postfach 2020 D-73510 Schwäbisch Gmünd		Zeichnungsnummer drawing-no.	A7000/467	ident. -no.:	267225	CRD-Version: 5.60.3	page	56
date	20.04.07	drawn	AKO	USA	origin	repl. for 266596	repl. by							page	56
name		norm												pages	57

page/path		24. 4	24. 4	24. 4																
terminal block Leistungsbezeichnung <b>X55a</b>	connection			6																
	finish designation	X55	C17																	
	bridges																			
	terminal number	1	2	3																
	connection			7																
	finish designation	M8	M8	X55																
cabelname type color																				

0		1		2		3		4		5		6		7		8		9	
		date 20.04.07		Typ 7019/100 HD		X55a													
		drawn AKO		Cayenne		USA													
2/3		25.07.07		checked AKO															
modific. date		name norm		origin		repl. for 266596		repl. by											

**UWE GmbH**  
 Buchstrasse 82 · Postfach 2020  
 D-73510 Schwäbsch Gmünd



Zeichnungsnummer **A7000/467**  
 drawing-no.

ident.-no.: 267225  
 CAD-Version: 5.60.3  
 page **57**  
 57 pages

	page/path	26.5	26.5																
terminal block Leistenbezeichnung <b>X80</b>	connection	-	+																
	finish designation	T4	T4																
	bridges																		
	terminal number	1	2																
	connection	8	10 X25:1																
	finish designation	X1	X1 A2																
cabelname		type		color															
WX80/A2		1x		1															

57 **Klemmenplan terminal diagram**

		1	2	3	4	5	6	7	8	9	
		date	10.01.07	Typ 7019/100 HD Cayenne		X80		Zeichnungsnummer <b>A7000/467</b>			
		drawn	AKO	USA				drawing-no.			
2/3	25.07.07	checked	AKO					ident.-no. :		CRD-Version: 5.60.3	page <b>58</b>
modific.	date	name	norm	origin	repl. for	repl. by		267225			57 pages

**uwe GmbH**  
 Buchstrasse 82 · Postfach 2020  
 D-73510 Schwäbisch Gmünd



Zeichnungsnummer **A7000/467**  
 drawing-no.  
 ident.-no. :  
 267225  
 CRD-Version: 5.60.3  
 page **58**  
 57 pages



page/path		26.4	26.5																	
terminal block Leistenzeichnung <b>X10b</b>	cabelname	type	color																	
	connection			43																
	finish designation			X52	X52															
	bridges																			
	terminal number				3	4														
	connection				R13	X1:1	R13	X1:2												
	finish designation																			
	color																			
	wh							X												

58 Klemmenplan terminal diagram

0	1	2	3	4	5	6	7	8	9
	date 20.04.07	Typ 7019/100 HD	X10b				Zeichnungsnummer A7000/467		
	drawn AKO	Cayenne					drawing-no.		
2/3	25.07.07	checked AKO	USA				ident.-no.:		page 59
modific. date name norm		origin	repl. for 266596	repl. by	UWE GmbH		CAD-Version: 5.60.3		57 pages
					Buchstrasse 82 · Postfach 2020 D-73510 Schwäbsch Gmünd		267225		